

## OWNER'S GUIDE

MODEL

639



**Open Decorative  
Gas Fire**

(G.C No. 32-032-47)

**THIS APPLIANCE IS FOR USE WITH NATURAL GAS (G20)  
WHEN CONVERTED USING CONVERSION KIT NO. 0591301 THIS  
APPLIANCE IS FOR USE WITH PROPANE GAS (G31)  
THIS APPLIANCE IS FOR USE IN THE UNITED KINGDOM (GB) AND  
THE REPUBLIC OF IRELAND (IE) ONLY.**

This guide is intended to help you care for your Valor gas fire. Please read thoroughly before using and keep for future reference

We trust that this guide gives sufficient details to enable your appliance to be operated and maintained satisfactorily. However, if further information is required, our

**Valor Technical Helpline** will be pleased to help.  
Please telephone **08706 061 065** (National call rates apply).

**This guide to be left with the owner**

# OWNER'S GUIDE

## **Safety First.**

Valor fires are CE Approved and designed to meet the appropriate British Standards and Safety Marks.



## **Quality and Excellence.**

At the heart of every Valor fire.

All Valor fires are manufactured to the highest standards of quality and excellence and are manufactured under a BS EN ISO 9001 quality system accepted by the British Standards Institute.



## **The Highest Standards**

Valor is a member of the Society of British Gas Industries which works to ensure high standards of safety, quality and performance.



## **Careful Installation**

Valor is a CORGI registered company. All our gas fires must be installed by a competent CORGI Registered Installer in accordance with our Installer Guide and should not be fitted directly on to a carpet or floor of combustible material.



Valor Heating, Erdington, Birmingham B24 9QP

[www.valor.co.uk](http://www.valor.co.uk)

Because our policy is one of constant development and improvement, details may vary slightly from those given in this publication

# OWNER'S GUIDE

## LIST OF CONTENTS

<b>SAFETY .....</b>	<b>4</b>
<b>APPLIANCE DIMENSIONS.....</b>	<b>6</b>
<b>GAS CONSUMPTION .....</b>	<b>7</b>
<b>OPERATING THE FIRE.....</b>	<b>7</b>
The Oxysafe flame sensing & flue blockage safety system. ....	7
To light the fire.....	8
Lighting with a taper .....	9
<b>CLEANING .....</b>	<b>10</b>
Metal parts .....	10
Coals and Pebbles.....	10
Ceramic burner.....	10
<b>FUEL BED REFITTING - COAL .....</b>	<b>11</b>
<b>FUEL BED REFITTING - PEBBLES .....</b>	<b>16</b>
Regular maintenance .....	22
Servicing.....	23
<b>USEFUL NUMBERS .....</b>	<b>24</b>

---

This gas fire is designed to meet the most stringent quality, performance and safety requirements to provide you with many years' trouble-free service.

This guide aims to improve your understanding and appreciation of your gas fire by providing simple and informative instructions to ensure that you benefit from the excellent performance and features it has to offer.

# OWNER'S GUIDE

## SAFETY

### IF YOU SMELL GAS

**DON'T SMOKE**

**EXTINGUISH ALL NAKED FLAMES**

**DON'T TURN ELECTRICAL SWITCHES ON OR OFF**

**TURN OFF THE GAS SUPPLY AT THE METER**

**OPEN DOORS AND WINDOWS TO GET RID OF THE GAS**

**IMMEDIATELY CALL THE GAS EMERGENCY SERVICE - SEE YOUR LOCAL TELEPHONE DIRECTORY**

- **Do** have the fire installed by a competent person. In the United Kingdom, installation must be in accordance with the latest edition of the Gas Safety (installation & use) Regulations. In the Republic of Ireland, installation must be in accordance with all national and local regulations in force.
- **Do** have the chimney swept prior to installation if it was previously used for solid fuel.
- **Do** have the fire installed in accordance with the installation instructions.
- **Do** provide a minimum clearance as shown in graph 1, above the top surface of the fireplace to the underside of any shelf made from wood or other combustible material

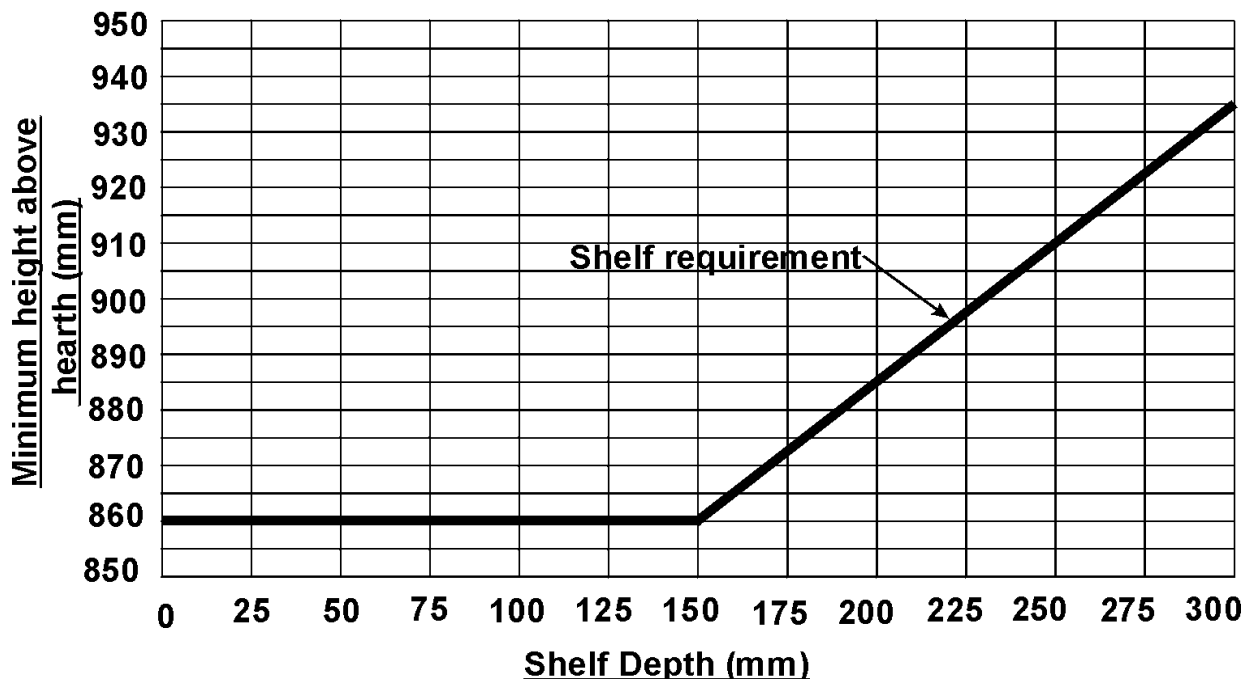

Graph 1. Combustible shelf clearances.

## OWNER'S GUIDE

- **Do** provide a suitable guard that complies with BS 6539 or 6778 for the protection of young children, the elderly and the infirm. Such a guard is also recommended for the protection of pet animals. (Although this fire conforms to all the applicable standards, it is a heating appliance and certain parts of its surface will become hot.).
  - **Do** wait three minutes before attempting to relight if the fire is switched off or the flames are extinguished for any reason. (Your fire is fitted with a safety device that will automatically shut off the gas supply to the fire if, for any reason, the flames go out.).
  - **Do** get advice about the suitability of any wall covering near your fire. Soft wall coverings (e.g. embossed vinyl, etc.) which have a raised pattern are easily affected by heat. They may, therefore, scorch or become discoloured when close to a heating appliance. Please bear this in mind whenever you are considering redecorating.
  - **Do** provide a minimum side clearance as detailed in figure 1. Please bear this in mind if ever you are considering altering the room.
- 
- **Don't** hang clothing, towels or any other fabrics over the front of the fire.
  - **Don't** add any extra coals above the number stated in this guide. This could cause a safety hazard.
  - **Don't** put paper or any other material on the fire.
  - **Don't** place any combustible material (rugs, carpet, plastic tiles, etc.) on the hearth.
  - **Don't** attempt to clean or service the fire until it has been switched off and allowed to cool completely.

# OWNER'S GUIDE

## APPLIANCE DIMENSIONS

Combustible projections up to 75mm forward of the fixing plane of the fire to be a minimum of 125mm from the fireplace opening. Projections above 75mm forward of the fixing plane of the fire to be a minimum of 178mm from the fireplace opening. Non-combustible projections to be 75mm from the fireplace opening.

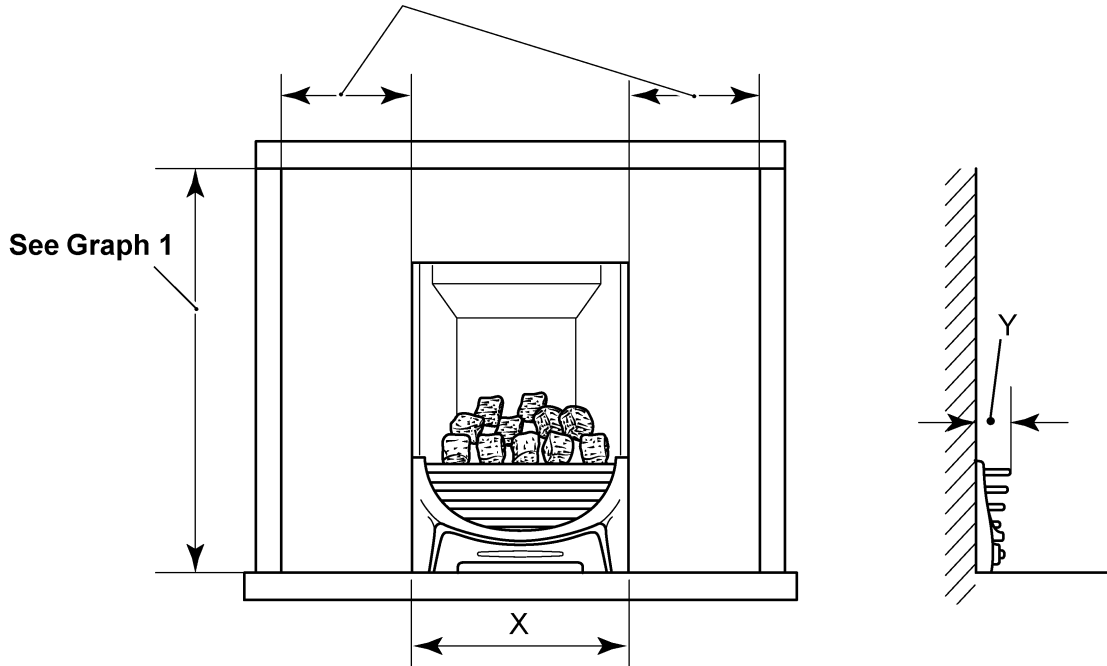

<b><u>Firefront</u></b>	<b><u>Dimension 'X' (mm)</u></b>	<b><u>Dimension 'Y' (mm)</u></b>
Azure	400	65
Quattro	390	65
Majestic	400	50

Figure 1. Appliance dimensions.

# OWNER'S GUIDE

## GAS CONSUMPTION

### Model 639

Has a maximum natural gas input of 6.85kW (Gross)

Has a minimum natural gas input of 2.3kW (Gross)

### Model 639 when converted using kit number 0591301

Has a maximum propane gas input of 6.7kW (Gross)

Has a minimum propane gas input of 4.0kW (Gross)

## OPERATING THE FIRE

### *PLEASE NOTE*

When operating your fire for the first time, some vapours may be given off which may cause a slight odour and could possibly set off any smoke alarms in the immediate vicinity. These vapours are quite normal with new appliances. They are totally harmless and will disappear after a few hours use.

### **The Oxysafe flame sensing & flue blockage safety system.**

For your safety, this appliance is fitted with a flue blockage safety device that will shut down the appliance in the event of abnormal flue conditions. ***This device is NOT a substitute for an independently mounted Carbon Monoxide detector.***

The device will also automatically shut off the gas supply to the fire if the pilot flame goes out due to lack of oxygen or for any other reason.

***If this device starts to repeatedly shut off the gas, get expert advice.***

This device incorporates a probe that senses that the heat from the pilot flame is correct. If this probe is cool, the device will prevent any gas flow unless the control knob is held in at the ignition position.

If, for any reason, the flames go out when the fire is hot or if the fire is turned off when hot, always ***wait at least three minutes before attempting to relight.***

## To light the fire

Depress the control knob and rotate it anticlockwise to the pilot ignition position. A 'click' will be heard as the integral piezo operates. A flame should appear at the pilot. Keep the control knob depressed and hold the pilot ignition position for five seconds. When the control knob is released the pilot flame should remain lit. If a flame does not appear at the

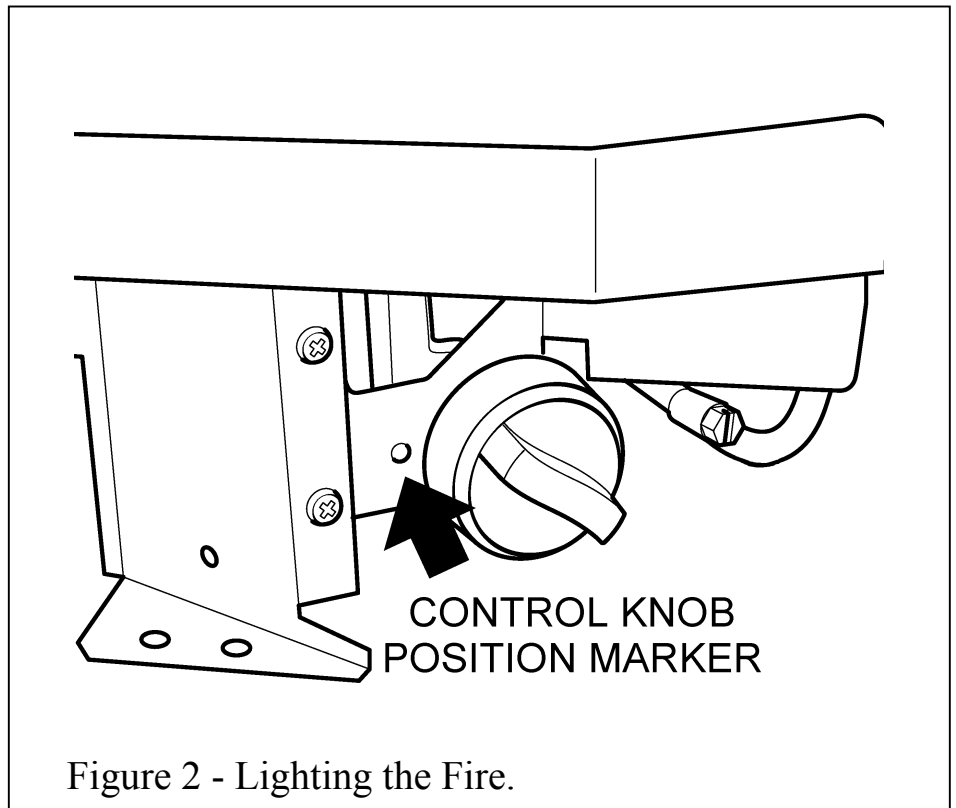

Figure 2 - Lighting the Fire.

pilot then turn the control knob clockwise to the 'OFF' position and repeat the above.

When the pilot burner is operating properly, gradually turn the control knob anticlockwise to 'HIGH' position. (Depress the knob slightly to get past the pilot ignition position). The main burner should now light.

Depress the control knob slightly to release from the 'HIGH' position and turn back (clockwise) to 'LOW'. While turning, the burner flames should gradually become lower but remain alight. Depress the control knob slightly to release from the 'LOW' position and turn back (clockwise) to the Pilot ignition position. The main burner should extinguish but the pilot should remain alight. Depress the control knob slightly and turn back (clockwise) to turn OFF. This will extinguish the pilot. While cooling, the coals / Pebbles may make some crackling noises. This is quite normal.



# OWNER'S GUIDE

- If the flames go out while setting the control, repeat the full lighting procedure.
- If the flames repeatedly go out have the fire serviced.
- Please note. When first turned on the flames will appear predominantly blue. The coals / Pebbles will take time to warm up. Although some glow will be seen after approximately ten minutes, the full visual effect will only be apparent after a somewhat longer time.
- The appliance will operate to its maximum potential if the flue is primed during the first 20 – 30 minutes of operation. To do this, simply turn the control knob to its 'HIGH' setting. This will also burn off any carbon deposits that may have formed during previous operations.
- If operating the appliance for long periods it is beneficial occasionally to change the settings. This will also help to remove any carbon deposits that may form during operation.

## Lighting with a taper

See figure 3.

In the unlikely event of failure of the ignition spark, the pilot can be lit by a taper or long spill.

- Turn the control knob to the 'Pilot ignition' position
- Insert the taper or spill to the outer left hand side of the front Coal / Pebbles.
- Depress the control knob. A flame should appear at the pilot.
- Remove the taper and keep the control depressed for 5 seconds.
- Release the control knob and the pilot flame should remain alight. If it does not, repeat the above.
- Turn the control knob to the required setting.

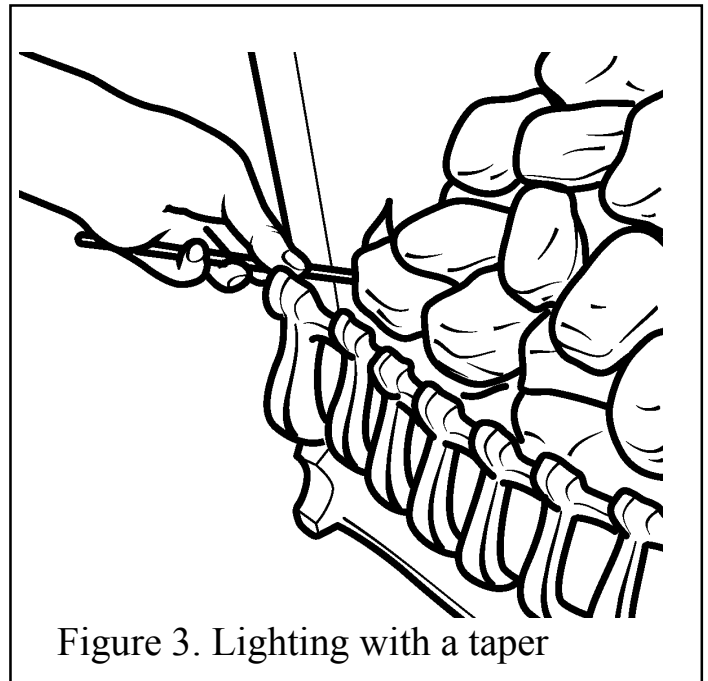

Figure 3. Lighting with a taper

# OWNER'S GUIDE

## CLEANING

Turn the fire off and allow it to cool completely before attempting any cleaning. Note that the fire will retain heat for some time after it has been turned off.

*If large pieces of debris are found anywhere in the fireplace, have the chimney inspected before further use.*

### Metal parts

Clean the metal parts with a slightly damp cloth and then dry. ***Do not use abrasive cleaners, they could scratch the surface.***

### Coals and Pebbles

**This product uses fuel effect pieces containing Refractory Ceramic Fibres (RCF), which are man-made vitreous silicate fibres. Excessive exposure to this material may cause irritation to eyes, skin and respiratory tract. Consequently, it is important to take care when handling these articles to ensure that the release of dust is kept to a minimum.**

- Light coatings of soot will usually be burnt off during the normal operation of the fire.
- Should any soot accumulation become excessive, the fuel effect pieces should be removed from the fire for cleaning.
- Cleaning should be carried out in a well-ventilated area or in the open air by gently brushing with the pieces held away from your face so that you avoid inhaling the dust.
- We do not recommend the use of a normal domestic vacuum cleaner that may blow dust back into the air.
- We suggest that you remove the coals / pebbles in the reverse order to that shown in the fuel bed refitting instructions.

### Ceramic burner

Remove any deposits of soot or other foreign matter from the solid areas of the burner with a dry soft brush. Be careful not to brush any particles into the open slots. Remove any particles from the slots with a vacuum cleaner fitted with a soft brush attachment. **Do not poke wire, etc. into the slots in the burner.**

## FUEL BED REFITTING - COAL

This section is for models supplied with a 'Coal' effect fuel bed only.

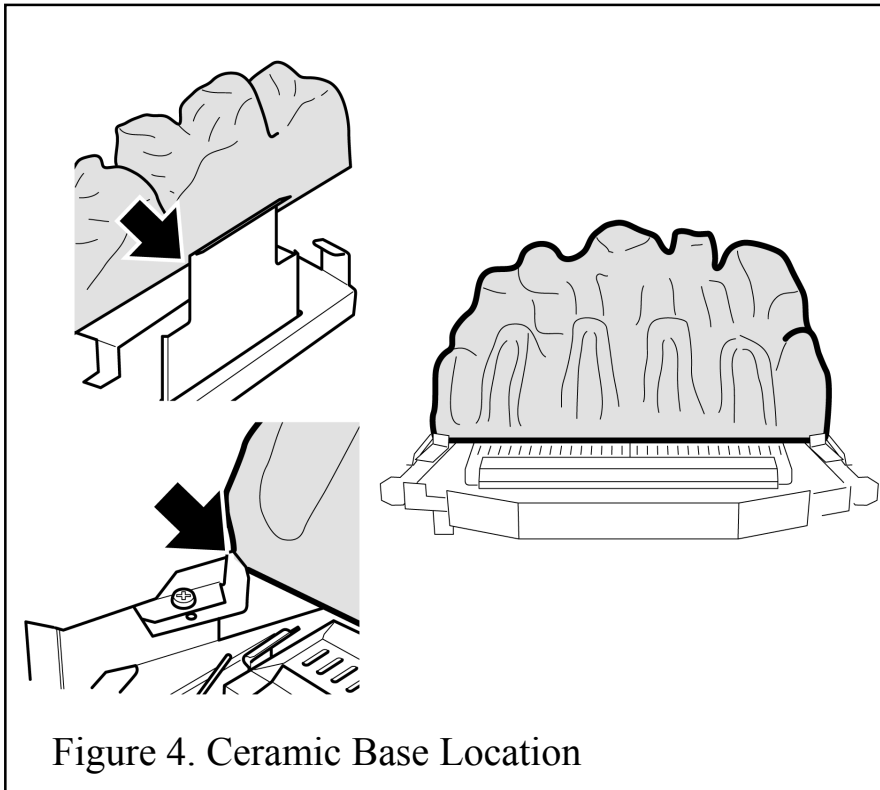

For 'Pebble fuel bed' see section headed '*Fuel Bed Refitting – Pebble*'.  
If the fuel bed components are dislodged or removed, they must be refitted as follows:

***Only the fuel bed parts supplied with this appliance or authorised Valor replacements must be used. Never add extra coals above the number stated in these instructions.***

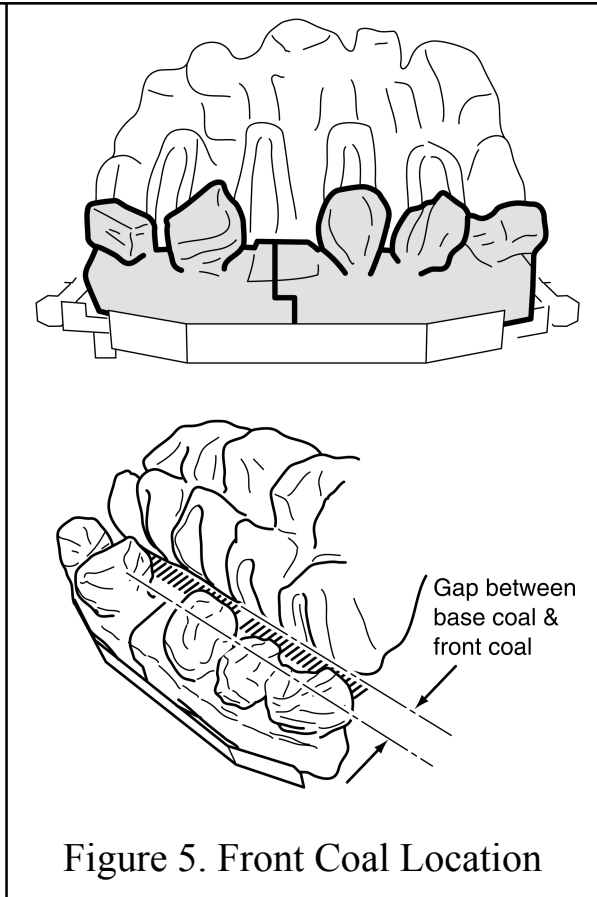

1. Place the ceramic base coal in the burner compartment. The bottom rear face of the coal should rest **against** the angled ledge at the back of the burner tray. ***The coal does not rest on top of the angled ledge.*** The bottom front edges of the coal base should locate against the left and right hand side brackets. (See figure 4).
2. Place the left-hand ceramic front coal in position in front of the base coal (See figure 5).
3. Place the right hand ceramic front coal in position in front of the base coal. This should overlap the left-hand coal. Push the two sides together to minimise the gap. (See figure 5).
4. There will be a gap between the rear of the front coals and the front of the base coal. (See figure 5).

# OWNER'S GUIDE

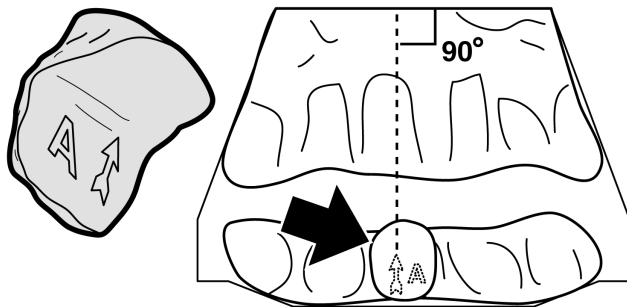
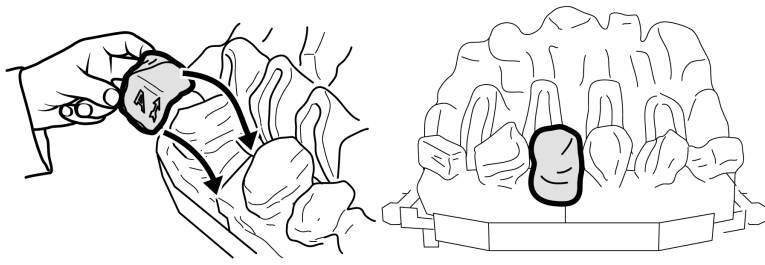

Figure 6. Front Row "Coal A"

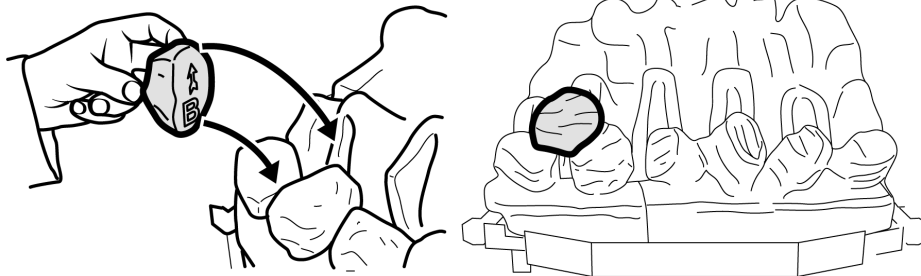

Figure 7. Second row "Coal B"



Figure 8. Second row "Coal C"

5. Install the 12 loose coals as follows. The underside of each coal is marked with a letter 'A' to 'L' and an arrow.

6. The coals should be positioned so that the arrows always point towards the back of the firebox. When located into position the stem of each arrow should be at 90° to the rear of the fireplace opening (See figure 6).

7. Hold coal 'A' upright with the arrow pointing to the top. Locate coal 'A' as shown in figure 6.

8. Locate coals 'B' to 'E' so that they are firmly seated in the valleys in the coal base and front coal.

9. Hold coal 'B' upright with the arrow pointing to the top. Locate coal 'B' as shown in figure 7.

10. Hold coal 'C' upright with the arrow pointing to the top. Locate coal 'C' as shown in figure 8.

# OWNER'S GUIDE

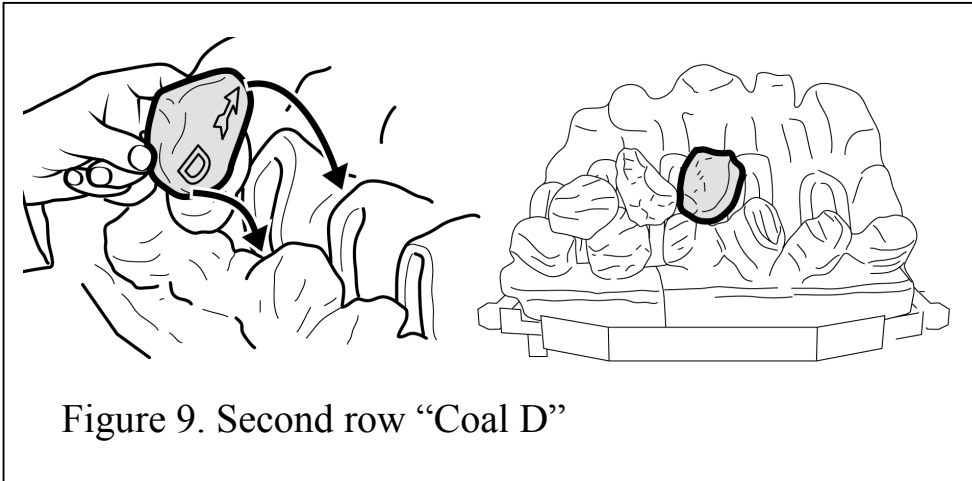

Figure 9. Second row "Coal D"

11. Hold coal 'D' upright with the arrow pointing to the top. Locate coal 'D' as shown in figure 9.

12. Hold coal 'E' upright with the arrow pointing to the top. Locate coal

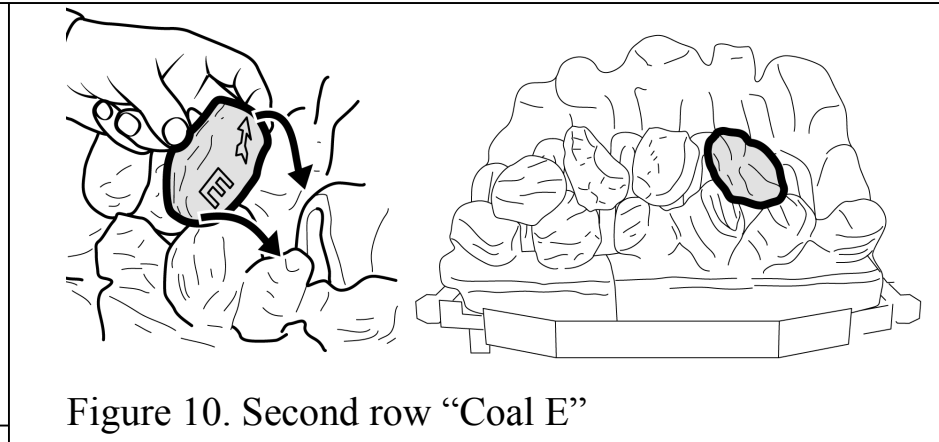

Figure 10. Second row "Coal E"

'E' as shown in figure 10.

13. Hold coal 'F' upright with the arrow pointing to the top. Locate coal 'F' as shown in figure 11.

14. This will

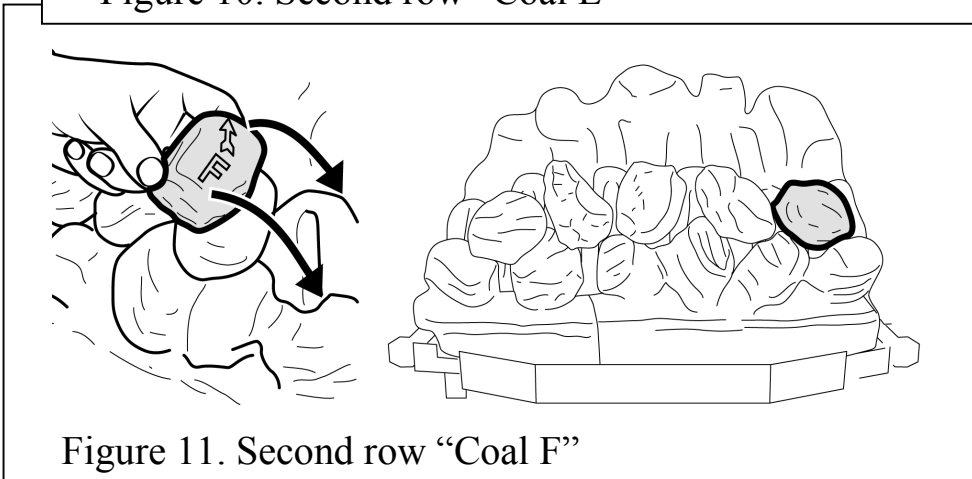

Figure 11. Second row "Coal F"

complete the second row of loose coals.

# OWNER'S GUIDE

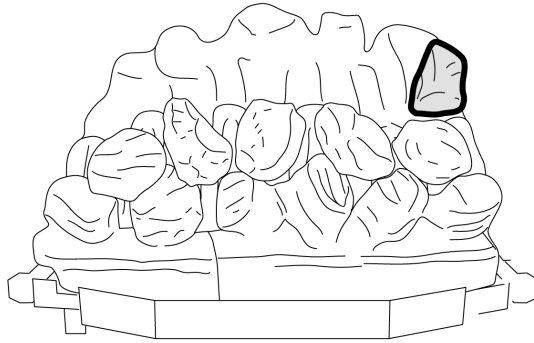
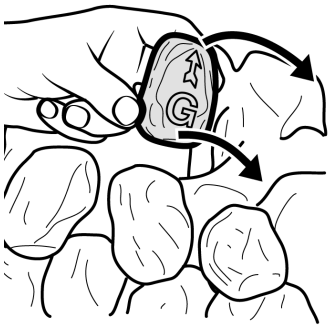

Figure 12. Third row "Coal G"

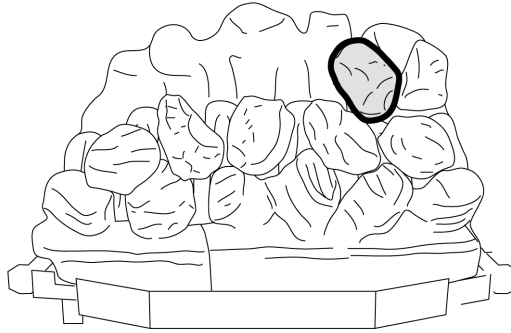
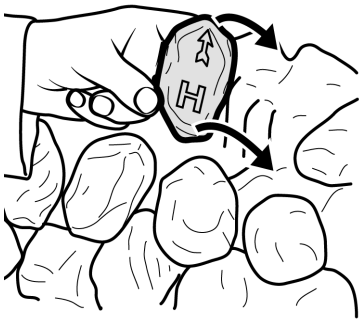

Figure 13. Third row "Coal H"

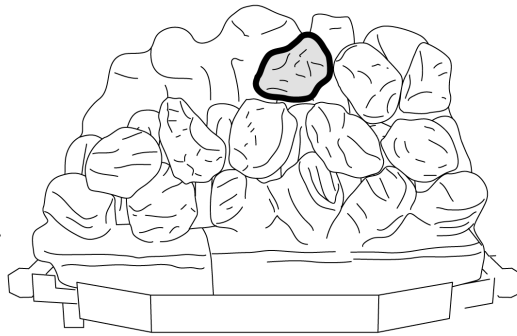
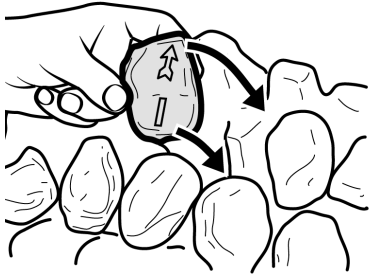

Figure 14. Third row "Coal I"

15. Locate coals 'G' to 'K' so that they are firmly seated in the valleys in the coal base.

16. Hold coal 'G' upright with the arrow pointing to the top. Locate coal 'G' as shown in figure 12.

17. Hold coal 'H' upright with the arrow pointing to the top. Locate coal 'H' as shown in figure

13  
18. Hold coal 'I' upright with the arrow pointing to the top. Locate coal 'I' as shown in figure 14.

# OWNER'S GUIDE

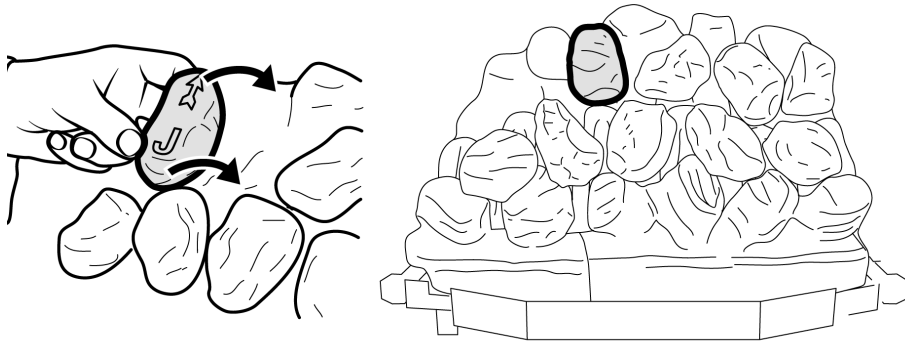

Figure 15. Third row "Coal J"

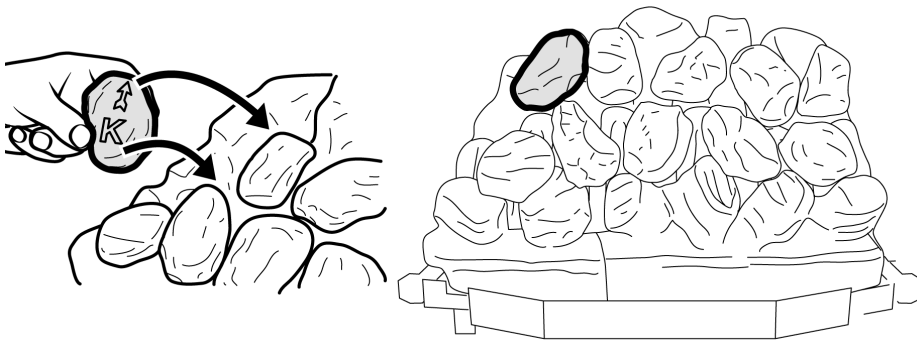

Figure 16. Third row "Coal K"



Figure 17 Third row "Coal L"

**19.** Hold coal 'J' upright with the arrow pointing to the top. Locate coal 'J' as shown in figure 15.

**20.** Hold coal 'K' upright with the arrow pointing to the top. Locate coal 'K' as

shown in figure 16

**21.** Hold coal 'L' upright with the arrow pointing to the top. Locate coal 'L' as shown in figure 17.

## FUEL BED REFITTING - PEBBLES

This section is for models supplied with a **'Pebble'** effect fuel bed only.

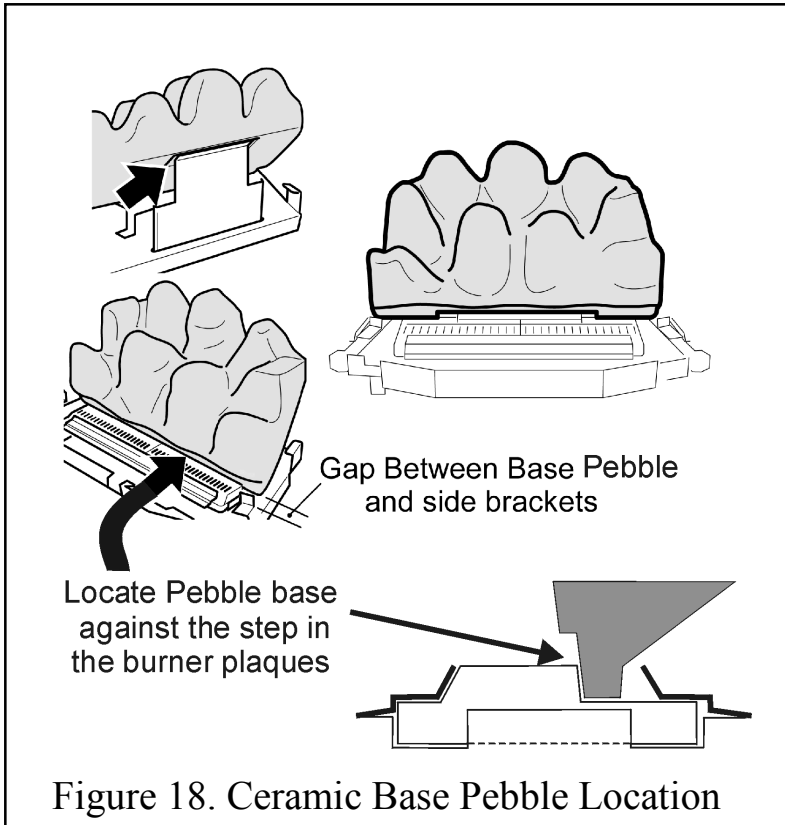

For 'Coal' see section headed 'Fuel Bed Refitting – Coal'. If the fuel bed components are dislodged or removed, they must be refitted as follows:

**Only the fuel bed parts supplied with this appliance or authorised Valor replacements must be used. Never add extra Pebbles above the number stated in these instructions.**

1. Place the ceramic pebble base in the burner compartment. The bottom rear face of the pebble base should rest on the angled ledge at the back of the burner

tray. The bottom front lower edge of the pebble base should locate against the step in the burner plaques. **The front edges of the pebble base should not come into contact with the metal brackets to the side of the burner tray** (See figure 18).

2. Place the left-hand ceramic front pebbles in position in front of the base pebbles (See figure 19).

3. Place the right hand ceramic front pebbles in position in front of the base pebbles. This should join with the left-hand pebbles. Push the two sides together to minimise the gap. (See figure 19).

4. There will be a gap between the rear of the front pebbles and the front of the base pebbles. (See figure 19).

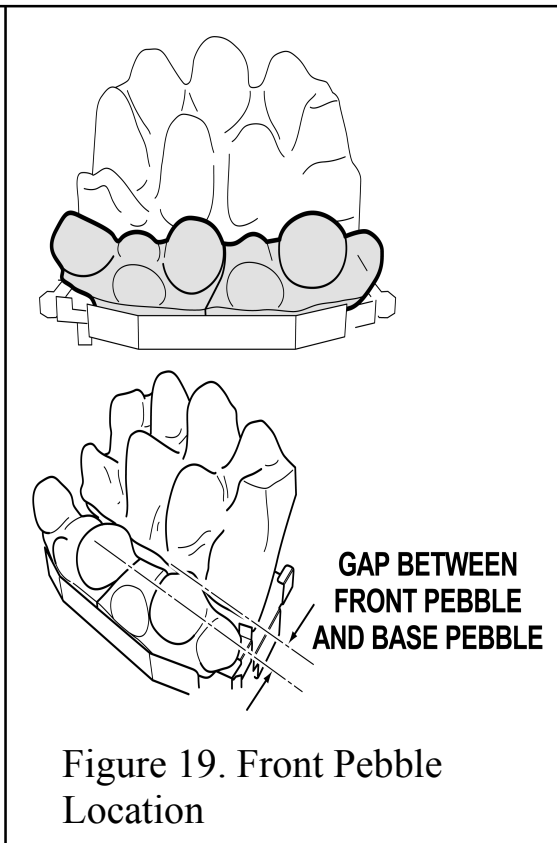



# OWNER'S GUIDE

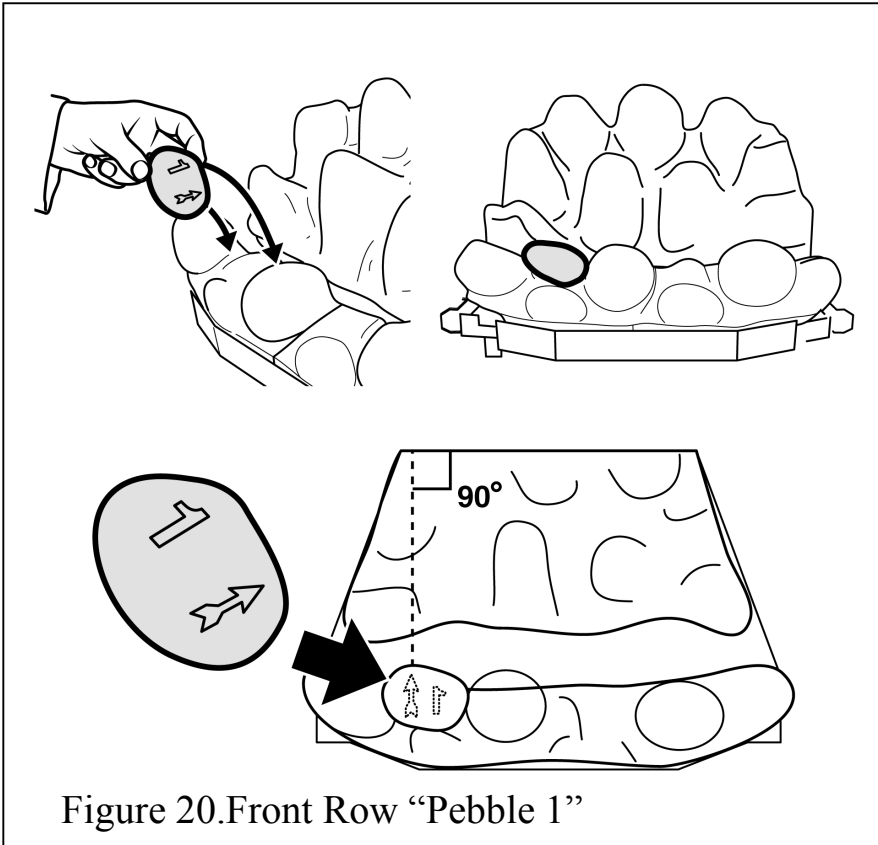

Figure 20. Front Row "Pebble 1"

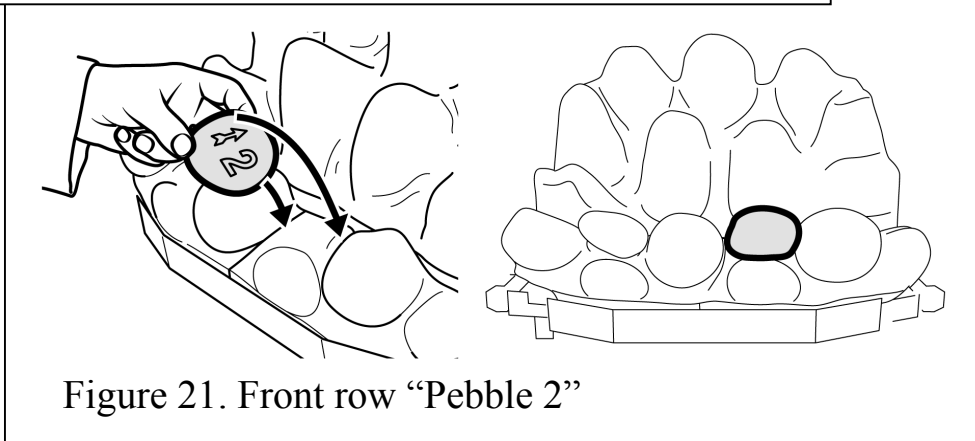

Figure 21. Front row "Pebble 2"

The position of the pebbles is important. Do not alter the position of the pebbles from that shown in this section of the owner's guide.

5. Install the 16 loose pebbles as follows. The underside of each pebble is marked with a number '1' to '16' and an arrow.

6. The pebbles should be positioned so that the arrows always point towards the back of the fireplace opening. When

located into position the stem of each arrow should be at 90° to the rear of the fireplace opening (See figure 20).

7. Hold pebble '1' upright with the arrow pointing to the top. Locate

pebble '1' as shown in figure 20. It should lie on top of the left hand front pebbles.

8. Hold Pebble '2' upright with the arrow pointing to the top. Locate Pebble '2' as shown in figure 21. It should lie on top of the right hand front pebbles

9. This will complete the front row of pebbles.

# OWNER'S GUIDE



Figure 22. Second row "Pebble 3"

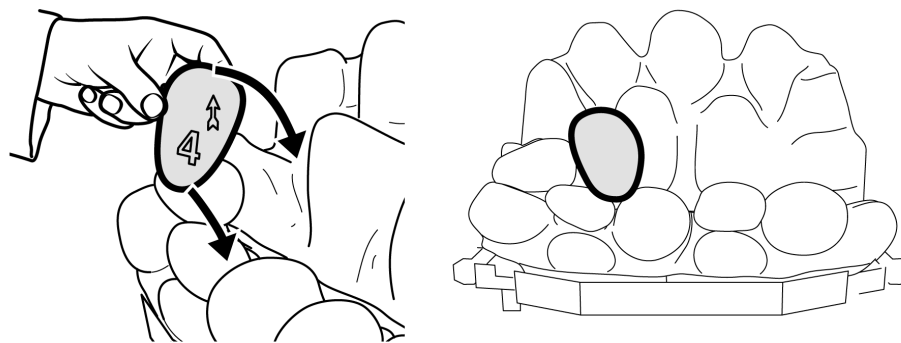

Figure 23. Second row "Pebble 4"

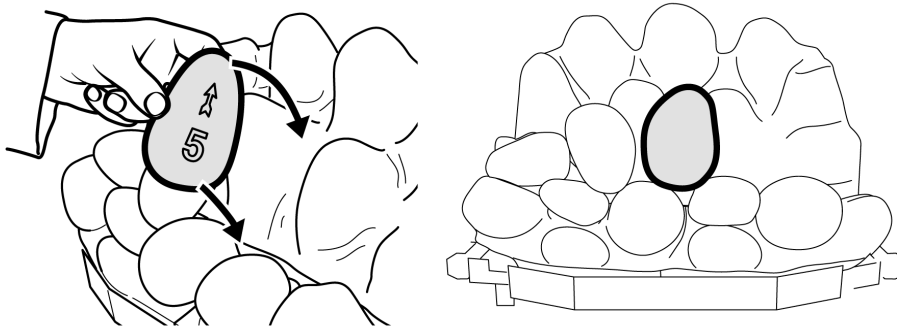

Figure 24. Second row "Pebble 5"



Figure 25. Second row "Pebble 6"

**10.** Locate pebbles '3' to '7' so that they are firmly seated in the valleys in the pebble base and front pebbles.

**11.** Hold pebble '3' upright with the arrow pointing to the top. Locate Pebble

'3' as shown in figure 22.

**12.** Hold pebble '4' upright with the arrow pointing to the top. Locate pebble '4' as shown in figure 23.

**13.** Hold pebble '5' upright with the arrow pointing to the top. Locate Pebble '5' as shown in figure 24.

**14.** Hold pebble '6' upright with the arrow pointing to the top. Locate pebble '6' as shown in figure 25.

# OWNER'S GUIDE

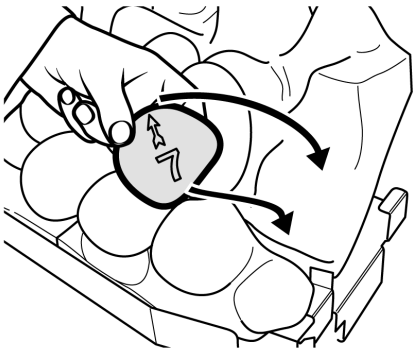
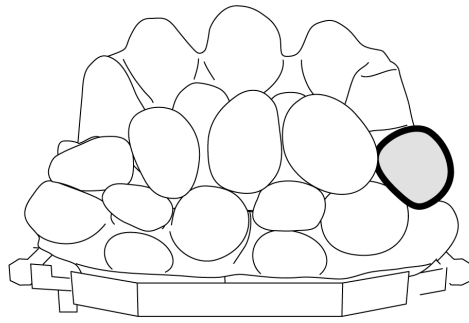

Figure 26. Second row "Pebble 7"



**15.** Hold pebble '7' upright with the arrow pointing to the top. Locate pebble '7' as shown in figure 26.

**16.** This will complete the second row of loose pebbles.

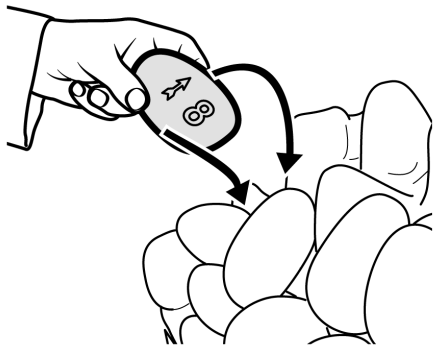
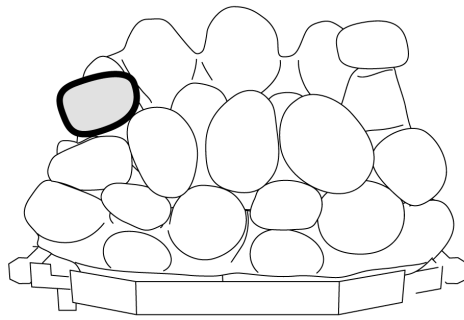

Figure 27. Third row "Pebble 8"



**17.** Locate pebbles '8' to '12' so that they are firmly seated in the valleys in the pebble base.

**18.** Hold pebble '8' upright with the arrow pointing to the top. Locate pebble '8' as shown in figure 27.

**19.** Hold pebble '9' upright with the arrow pointing to the top. Locate pebble '9' as shown in figure 28.

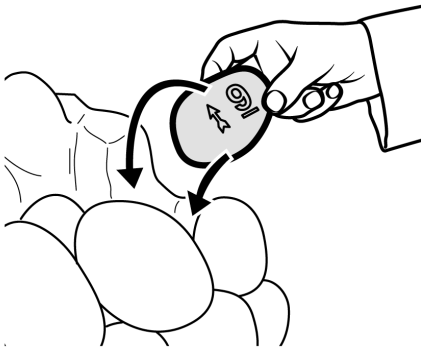
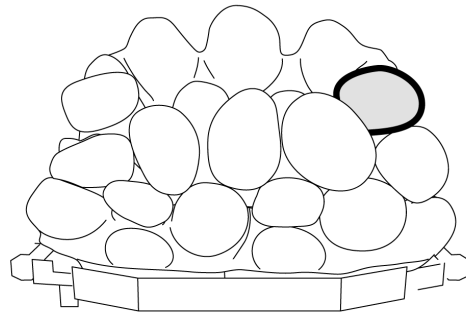

Figure 28. Third row "Pebble 9"



# OWNER'S GUIDE

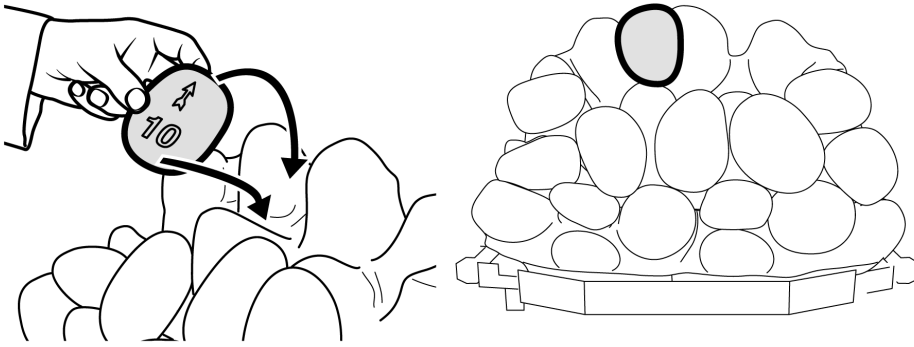

Figure 29. Third row "Pebble 10"

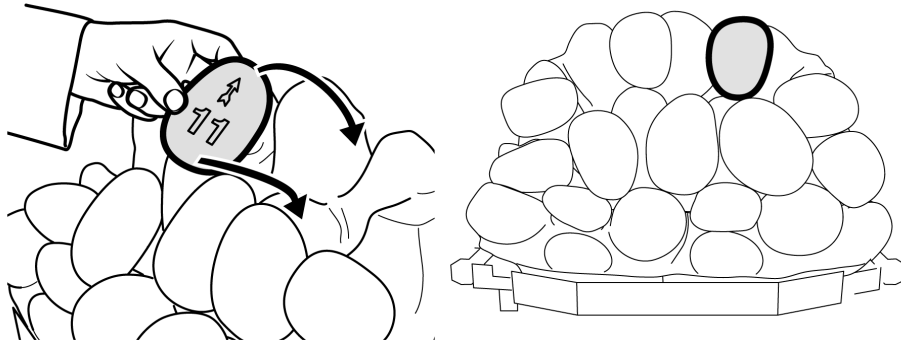

Figure 30. Third row "Pebble 11"



Figure 31. Third row "Pebble 12"

**20.** Hold pebble '10' upright with the arrow pointing to the top. Locate pebble '10' as shown in figure 29.

**21.** Hold pebble '11' upright with the

arrow pointing to the top. Locate pebble '11' as shown in figure 30

**22.** Hold pebble '12' upright with the arrow pointing to the top. Locate pebble '12' as shown in figure 31.

# OWNER'S GUIDE

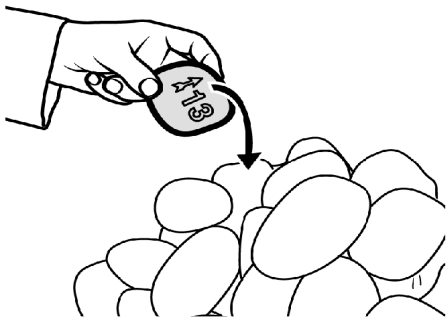
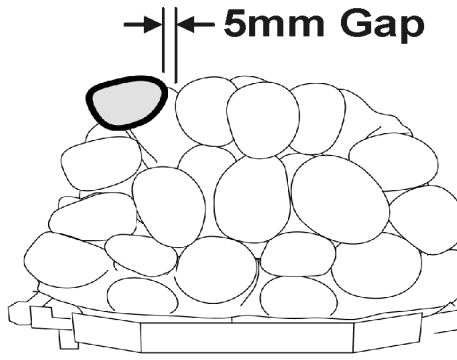

Figure 32. Fourth row "Pebble 13"



23. Hold pebble '13' upright with the arrow pointing to the top. Locate pebble '13' as shown in figure 32. Leave a 5mm gap between pebble 13 and the pebble to its right.

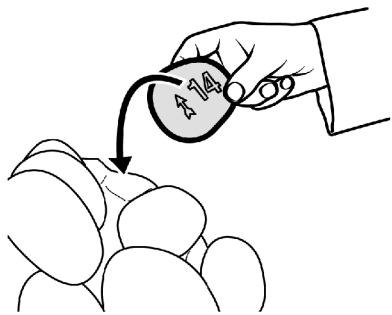
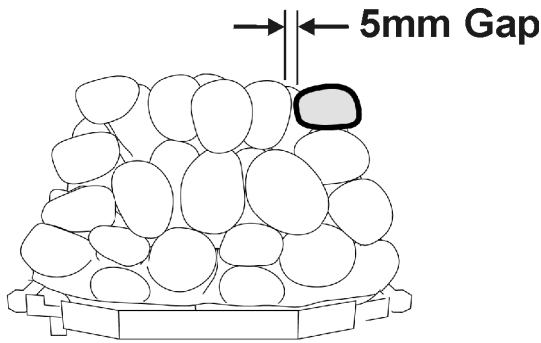

Figure 33. Fourth row "Pebble 14"



24. Hold pebble '14' upright with the arrow pointing to the top. Locate pebble '14' as shown in figure 33. Leave a 5mm gap between pebble 14 and the pebble to its left.

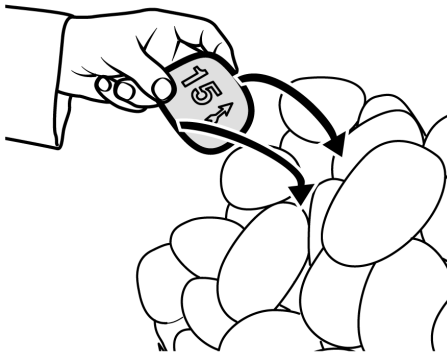
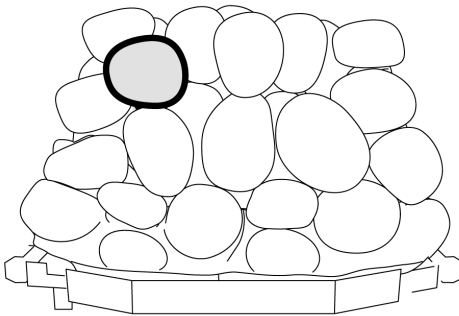

Figure 34 Fourth row "Pebble 15"



25. Hold pebble '15' upright with the arrow pointing to the top. Locate pebble '15' as shown in figure 34.

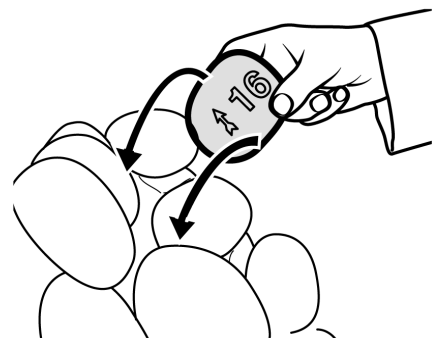
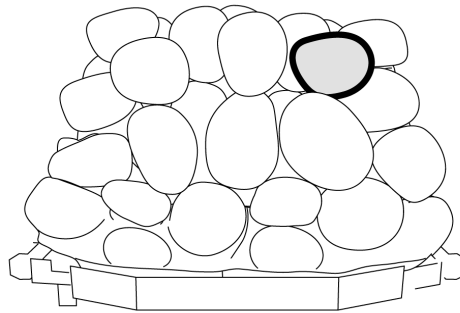

Figure 35 Fourth row "Pebble 16"



26. Hold pebble '16' upright with the arrow pointing to the top. Locate pebble '16' as shown in figure 35.

## Decorative firefront.

Place the decorative firefront on the hearth and centralise to the appliance.

## 'Quattro' firefront only

- Locate the firefront as in figure 36. The hooks should fit into the slots on the burner tray.
- The lower 'ashpan' should be located as in figure 37.

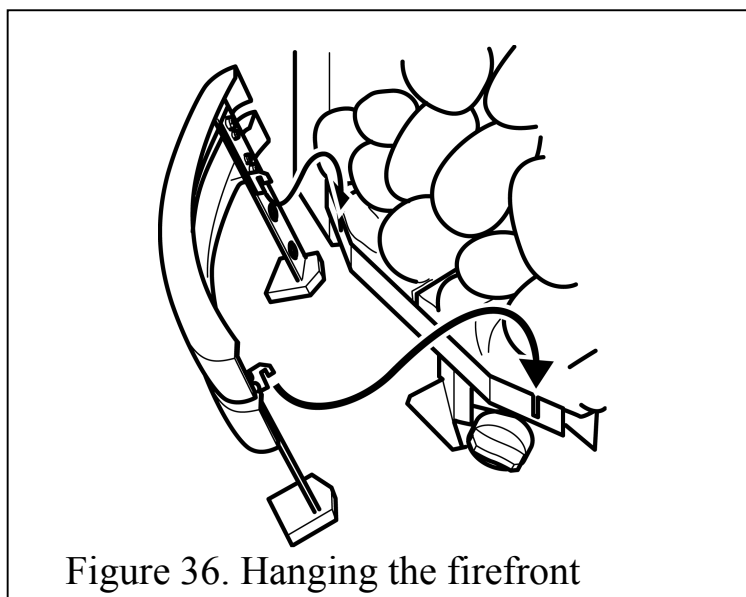

## Regular maintenance

In order to achieve and maintain high levels of personal safety and performance efficiency, it is essential that the opening at the back of the fire and the flue are kept clear of any form of obstruction. It is possible that deposits of mortar or soot could fall and accumulate causing the flue to be blocked or restricted and so preventing proper clearance of dangerous exhaust fumes.

In the United Kingdom it is the law that a landlord must have any gas appliance, flue and pipework which is situated in a tenant's premises checked for safety at least every twelve months by a competent person (In the U.K, a CORGI registered installer).

We recommend that all gas appliances and their flues, wherever situated, are checked annually.

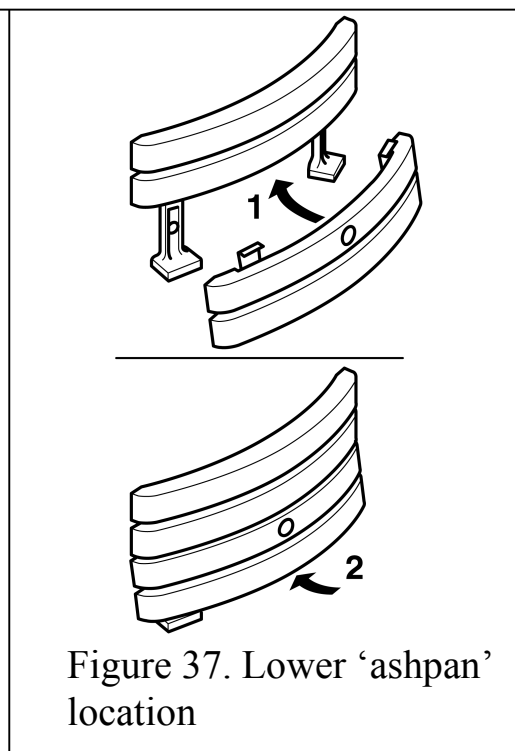

# OWNER'S GUIDE

## Servicing

Servicing can be carried out either by a Valor Service engineer or a CORGI registered installer. If you require your fire to be serviced, please contact **Valor Service** on **08706 090 081** and quote the following details. These can be found on the data plate tied to the underside of the burner.

**Your Post Code.**

**Type of fire.**

**Model/Name.**

**Serial Number.**

**The fault, problem or request.**

If you wish to replace any of the owner replaceable parts listed below, please contact **Valor Spares** on **08706 000 454** for your nearest stockist of these parts.

Description	Part No.	
	Model 639 (Nat gas)	Model 639 (Propane)
<b>Models with 'Coal' fuel effect bed.</b>		
Coal Matrix	3002190	3002190
Front Coal Set	3002330	3002330
Pack of 12 Loose Coals	3002193	3002193
<b>Models with 'Pebble' fuel effect bed.</b>		
Pebble Matrix	3002448	3002448
Front Pebble Set	3002516	3002516
Pack of 16 Loose Pebbles	3002442	3002442

When fitting replacement parts, follow the instructions contained in this guide. It is important that only Valor approved parts are used for maximum safety.

# **OWNER'S GUIDE**

## **USEFUL NUMBERS**

**General advice about gas and your gas fire:**

**VALOR TECHNICAL HELPLINE 08706 061 065.**

**To report faults or arrange for your fire to be serviced:**

**VALOR SERVICE 08706 090 081.**

**For sales or product information:**

**VALOR SALES 08706 061 067.**

**To order spares:**

**VALOR SPARES 08706 000 454**

**CALLERS IN THE REPUBLIC OF IRELAND**

**Call 0044 08706 061 064**

Valor Heating, Erdington, Birmingham B24 9QP

Because our policy is one of constant development and improvement, details may vary slightly from those given in this publication.