



Saunier Duval

ThemaPLUS CONDENS

**High Efficiency
Condensing Boiler**



ThemaPLUS CONDENS F30E Combination boiler

ThemaPLUS CONDENS

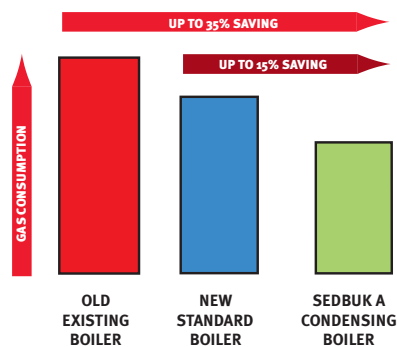

Energy Efficiency Recommended is an Energy Saving Trust initiative backed by the government. The logo is only found on products that have been carefully selected for their energy efficiency. Buy where you see the sign and help save energy, money and the environment.



Saunier Duval and High Efficiency

Over a decade of pioneering experience in manufacturing high efficiency means that Saunier Duval is renowned throughout Europe as a name that provides you with innovative home heating solutions, creating a range of high efficiency boilers suitable for all applications. Right across the continent, we have built a reputation for providing our customers with the greatest possible comfort and peace of mind.

High Efficiency, low bills

Condensing boilers take more heat from the combustion gases and use energy that would otherwise be wasted. There are a number of benefits to be gained by fitting a high efficiency boiler:

- 1. It saves money** – a SEDBUK A condensing boiler typically consumes 30-35% less gas than an old existing boiler so bills will be lower.
- 2. It saves the planet** – fitting a condensing boiler contributes to reducing greenhouse gas emissions.

ThemaPLUS CONDENS High Efficiency Condensing boilers

The ThemaPLUS CONDENS gives you the unlimited hot water benefit of a combination boiler with hot water to the tap at a speed you normally expect from a hot water cylinder.

Comfort

- The micro accumulator provides hot water in just 5 seconds.
- Easy to use control panel with a built-in 7 day timer allows simple, effective heating control.

Reliability

- The high grade stainless steel heat exchanger provides excellent corrosion resistance.
- Filters on mains water inlet and central heating return prevent blockages.
- A daily pump exercise program delivers assured product performance every day of the year.

Simplicity

- The telescopic flue makes installation easier with no need to cut to fit.
- Built in filling loop and system bypass removes the need for extra external plumbing.
- Built-in 7 day timer removes the need to fit an external timer.
- Multiple fixing point options ensure ease of fixing in all types of house.
- Pipe connections clip distance from the wall ensures easy connection of system pipe work.

Flexibility

- Extensive flueing options and frost protection means a ThemaPLUS CONDENS can be sited almost anywhere.
- The Saunier Duval Plume Diverter Kit is fully compatible with the ThemaPLUS CONDENS, allowing any flue termination or plumbing issues to be overcome.
- Zero compartment ventilation means the ThemaPLUS can be installed in a cupboard or compartment.

Efficiency

- The ThemaPLUS CONDENS boiler achieves a SEDBUK A rating – the highest efficiency rating possible.
- Adaptive regulation automatically calculates the perfect level of domestic comfort whilst minimising energy consumption.



2 year
warranty*



SEDBUK A
rated



Built-in
7 day timer



Self
diagnostics



5 sec HW
delivery



*1 year labour, 2 years parts.



Control panel

Easy to use control panel which includes a built in 7 day timer, digital display with on-board diagnostics and fault code display.

Overview

The ThemaPLUS CONDENS gives you a combination boiler's unlimited hot water to the tap in just 5 seconds – which is faster even than many standard boilers. Its easy-to-use control panel makes life simple for the installer and end user alike, yet it boasts all the efficiency of the rest of the Saunier Duval range. In addition, anti-seizure controls and frost protection make it both reliable and user friendly.

And for those who live without a mains gas supply, the Thema CONDENS can be converted to G31 propane in the field without the use of a conversion kit.

Stainless steel heat exchanger

High grade stainless steel provides excellent corrosion resistance and product reliability.

House suitability

Typical 2/3 bedroom house.



ThemaPLUS CONDENS F30E features

- 1 Stainless steel heat exchanger
- 2 Burner
- 3 Ignition electrode
- 4 Spark generator
- 5 Silencer
- 6 Mixing arm
- 7 Air/gas ratio controller
- 8 Fan
- 9 Pump
- 10 Filling loop
- 11 Pressure relief valve
- 12 Central heating return filter
- 13 Three way valve
- 14 Overheat cut off switch
- 15 Control box

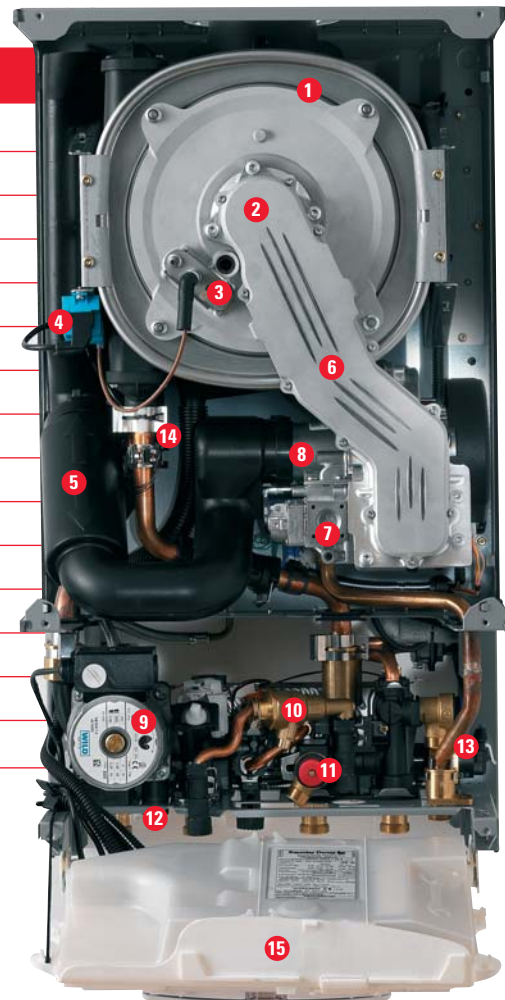

Microfast

The ThemaPLUS CONDENS has an ingeniously simple built-in storage vessel that keeps 3 litres of domestic water heated using a small electrical element. The result is a five second hot water response when a hot tap is turned on.



Service for peace of mind

At Saunier Duval we are committed to giving you peace of mind and our service offer is designed to do just that.

We have an unrivalled national service network, and in the unlikely event of a problem, you can reach our call centre 7 days a week 364 days a year, with our team of highly trained service engineers on call 6 days a week throughout the year.

All this combines to ensure Saunier Duval provides the most professional, flexible and highest quality service possible to all of our customers.



Warranty for confidence and satisfaction

All Saunier Duval condensing boilers are supported by a 2 year parts warranty and a 1 year labour warranty to ensure your long term confidence and satisfaction. For ultimate peace of mind, you can choose one of our Extended Warranty options.

Technical helpline	01773 828 400
General helpline	0870 606 4351
In-Warranty service	01773 525 914
Installer training	01773 596 174



Technical specifications and Flue options

ThemaPLUS CONDENS technical specifications	
Model	F30E
Household suitability	Typical 2/3 Bedroom House
Output heating 80°C / 60°C	23.6 kW
Output heating 50°C / 30°C	25.8kW
Output DHW	29.6 kW
Flow rate @ 35°C Δt	12 l/min
Weight	41.8 kg
Clock	Built-in 7 day timer
Gas type	Nat/LPG
Min water supply pressure	0.5 bar
Max system capacity @ 75°C	160 l
SEDBUK rating	A
DIMENSIONS	
Height	742 mm
Width	410 mm
Depth	394 mm
CLEARANCES	
Top	150 mm
Bottom	200 mm
Side	5 mm
Flue Type	Fan flued
Flue Size	100 mm
Max flue length horizontal	5.5 m
Max flue length vertical	6.5 m
Max flue length twin flue	40 m

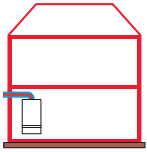
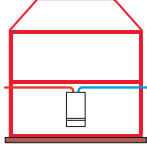
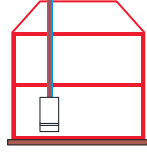
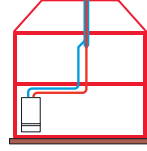
Flue options
Horizontal concentric flue 
Horizontal twin pipe flue 
Vertical concentric flue 
Vertical twin pipe flue 
For a comprehensive guide to flueing, please call 01773 596 190

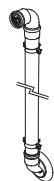

Plume Diverter Kit

The Saunier Duval Plume Diverter Kit makes siting your boiler easy by enabling you to overcome any flue termination or plumbing issues. The ThemaPLUS CONDENS is fully compatible with the Plume Diverter Kit.



Water Research Council approved. British Gas Service Listed. C.E. Energy Efficiency Recommended is an Energy Saving Trust initiative backed by the government. The logo is only found on products that have been carefully selected for their energy efficiency. Buy where you see the sign and help save energy, money and the environment.

Saunier Duval pursues a policy of continuous product improvement and reserves the right to alter specification and design without prior notice.



Saunier Duval

Nottingham Road, Belper,
Derbyshire DE56 1JT
Telephone 0870 606 4351
Facsimile (01773) 820569
www.saunier-duval.co.uk