

ISOFAST 
CONDENS



Saunier Duval

INSTRUCTIONS FOR USE

INSTRUCTIONS FOR USE, INSTALLATION AND SERVICING FOR ISOFAST CONDENS F 35 E

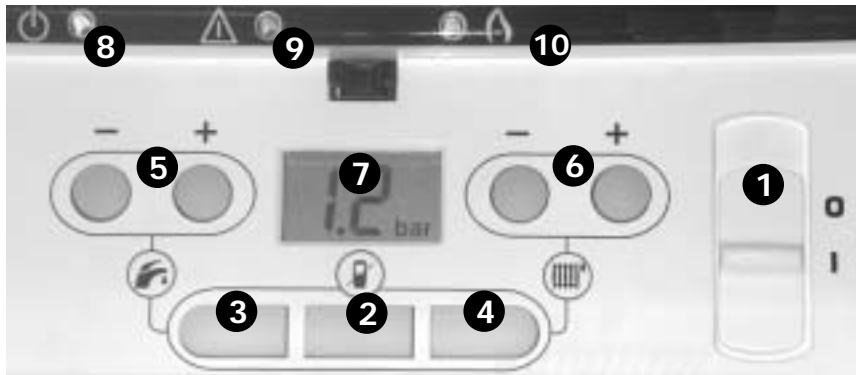

Lighting/switch off the boiler

Lighting : make sure that :

- the boiler is connected to the electrical supply,
- the gas service tap is open,
- Switch ON (I).

Switch off the boiler : Switch to OFF (0) : the electrical supply is off. Stop the gas supply if the boiler is to be out of use for a long time.



- 1 - On/Off switch.
- 2 - Room thermostat disabled when the button light is ON
- 3 - Sanitary function enabled when the button light is ON
- 4 - Heating function enabled when the button light is ON
- 5 - Hot water temperature adjuster.
- 6 - Heating temperature adjuster.
- 7 - Graphic display.
- 8 - Green running light.
- 9 - Red, flashing fault light.
- 10 - Yellow running lamp for the burner.

Operation without room thermostat

- Press the key (the key will light-up)
- Press the and/or buttons to activate the heating and/or hot water functions
- Use buttons **5** and **6** to determine the heating and hot water temperatures.
- To revert to the operating mode with room thermostat, again press the key (the light will turn OFF);

Important notice : The settings performed on the boiler control panel are not transmitted to the room thermostat.

Perform the temperature settings from the wireless room thermostat supplied together with the boiler, strictly adhering to the instructions given in this manual, pages 10 through 17.

Fault indication

In case of fault, the red warning light **9** will flash and a code appears on the boiler display **7**.

Code 21: Water pressure too low: open the blue tap (t) situated under the boiler until a pressure of 1.5 bar is obtained.

Other codes: press the key of the room thermostat and read the indications given by the display.



Important information

The instructions consist of three parts, User, Installation and Servicing Instructions, which includes the Guarantee Registration Card. The instructions are an integral part of the appliance and must, to comply with the current issue of the Gas Safety (Installation and Use) Regulations, be handed to the user on completion of the installation.

General

This combination boiler is able to provide room heating as part of a central heating system, and domestic hot water direct from the cold water supply without the need for secondary storage. The central heating water temperature and domestic hot water temperature can both be adjusted on the boiler.

Once the controls are set the boiler operates automatically. A frost protection program is also included.

Please read these instructions and follow them carefully for the safe and economical use of your boiler.

Gas Category

This boiler is for use only on Natural gas (G20) or propane (G31).

Gas Safety (Installation and Use) Regulations

In your own interests and that of safety, it is the Law that ALL gas appliances are installed by a competent person in accordance with the current issue of the above regulations.

Gas Testing and Certification

The boiler is tested and certificated for safety and performance.

It is, therefore, important that no alteration is made to the boiler unless approved, in writing, by Saunier Duval. Any alteration not approved by Saunier Duval, could invalidate the certification, boiler warranty and may also infringe the current issue of the statutory requirements.

CE Mark

This boiler meets the requirements of Statutory Instrument, No. 3083 The Boiler (Efficiency) Regulations, and therefore is deemed to meet the requirements of Directive 92/42/EEC on the efficiency requirements for new hot water boilers fired with liquid or gaseous fuels. Type test for purposes of Regulation 5 certified by : Notified body 0086. Product/production certified by : Notified body 0086.

Contents

INSTRUCTION FOR USE	
Controls and Lighting	page 2
Important informations	3 - 5
Guarantee informations	6 - 7
Controls informations	8 - 17

INSTALLATION INSTRUCTIONS

General informations	18
Dimensions	19
Technical Data	20 - 23
Boiler components	24
Schematic layout of boiler	25
Boiler location	26 - 27
Flue location and Ventilation	28 - 31
Heating System	32 - 33
Domestic Hot Water System	33
Boiler Installation	34
Piping installation	35 - 38
Electrical Connection	39
Commissioning on boiler	40 - 43
Commissioning on room thermostat	44 - 51
Gas conversion	52 - 53

SERVICING INSTRUCTION

Routine Cleaning and Inspection	54 - 59
Wiring Diagram	60 - 61
Fault Finding	61 - 63
Replacement of Parts	64 - 72
Spare Parts	73

Important information

The CE mark on this appliance shows compliance with :

1. Directive 90/396/EEC on the approximation of the laws of the Member States relating to appliances burning gaseous fuels.
2. Directive 73/23/EEC on the harmonisation of the Laws of the Member States relating to electrical equipment designed for use within certain voltage limits.
3. Directive 89/336/EEC on the approximation of the Laws of the Member States relating to electromagnetic compatibility.

Control of Substances Hazardous to Health

Under Section 6 of The Health and Safety at Work Act 1974, we are required to provide information on substances hazardous to health. The adhesives and sealants used in this appliance are cured and give no known hazard in this state.

Insulation Pads

These can cause irritation to skin, eyes and the respiratory tract. If you have a history of skin complaint you may be susceptible to irritation. High dust levels are usual only if the material is broken. Normal handling should not

cause discomfort, but follow normal good hygiene and wash your hands before eating, drinking or going to the lavatory. If you do suffer irritation to the eyes or severe irritation to the skin seek medical attention.

Spare Parts

REMEMBER, When replacing a part on this appliance, use only spare parts that you can be assured conform to the safety and performance specification that we require. Do not use reconditioned or copy parts that have not been clearly authorised by Saunier Duval.

Manual Handling Guidance

During the appliance installation and the replacement of the heat exchanger it will be necessary to employ caution and assistance whilst lifting as the appliance or component exceeds the recommended weight for a one man lift.

In certain situations it may be required to use a mechanical handling aid. Take care to avoid trip hazards, slippery or wet surfaces.

Gas Leak or Fault

If a gas leak or fault exists or

is suspected, turn the boiler mains electrical supply off and turn off the gas supply at the meter. Consult your local gas company or your local installation/ servicing company.

Electrical Supply Failure

The boiler must be earthed. The boiler will not work without an electrical supply. Normal operation of the boiler should resume when the electrical supply is restored. Reset any external controls, to resume normal operation of the central heating. If the boiler does not resume normal operation turn the mains reset switch off and on. If the boiler does not resume normal operation after this the overheat stat may have operated. The overheat stat would only operate under abnormal conditions and, under these circumstances; it would be advisable to consult your installation / servicing company.

Boilers Installed in a Compartment or Cupboard

If the boiler is fitted into a compartment or cupboard, it does not require any ventilation openings. Do not use the compartment or cupboard for storage.

Plumbing from flue terminal

Like all condensing boilers this appliance will produce a plume of condensation from the flue terminal in cool weather. This is due to the high efficiency and hence low flue gas temperature of the boiler. It is normal and not a fault indication.

Replacement Parts

If replacement parts are required contact Saunier Duval service using the telephone number on the back cover of this booklet. Please quote the name of the appliance this information will be on the front of the appliance.

Protection Against Freezing

The room thermostat automatically ensures a minimum installation temperature of 6°C. This protection is ensured by the room thermostat as long as it is active. This means that the  button of the boiler must not be lit and that the batteries of the room thermostat must be in good condition.

If you are out of home for a few days, use the holidays mode of your room thermostat, and set the Start and End dates, as well as the desired temperature.

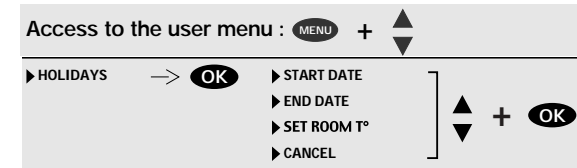

If the mains electricity and gas are to be turned off for any long periods during severe weather, it is recommended that the whole system, including the boiler, should be drained to avoid the risk of freezing.

Contact your installation/servicing company as draining, refilling and pressurising MUST be carried out by a competent person.

As a safety feature the boiler will stop working if the condensate drain becomes blocked. During freezing conditions this may be due to the forming of ice in the condensate drain external to the house. Release an ice blockage by the use of

warm cloths on the pipe. The boiler should then restart. Contact your installation/servicing company if the fault persists.

Draining and Filling

This boiler works in a pressurised system, which must only be drained, refilled and pressurised by a competent person.

Pressure Relief Safety Valve

A pressure relief safety valve and discharge pipe is fitted to the boiler. This valve must not be touched. Should there be any discharge from the pipe, isolate the boiler electrical supply and call your installer or Saunier Duval service using the telephone number on the back cover of this booklet.

USERS

Welcome users

Many thanks for choosing Saunier Duval market leaders in boiler manufacture,

Your appliance is guaranteed for a period of 24 months from the date of installation or 30 months from the date of manufacture whichever is the shorter and covers manufacturing defects only.

We, Saunier Duval, undertake to repair or replace parts free of charge which are recognised by us to be of faulty manufacture - if necessary after return to our factory for examination - on condition that :

- a) The appliance was installed by a qualified gas installer in accordance with installation instructions, and all the relevant codes of practice, standards and legislation in force.
- b) The appliance has been used for normal domestic purposes and in accordance with the manufacturer's operating and maintenance

instructions.

c) The appliance has not been serviced, maintained, repaired dismantled or tampered with during the guarantee period, by anyone other than an engineer approved by Saunier Duval.

d) The appliance is still in the possession of the original user, and proof of purchase in the form of a receipt or invoice is shown to the service engineer on request.

The repair or replacement of parts during the guarantee period does not have the effect of extending the period.

This guarantee does not cover :

- a) Any defects or damage resulting from incorrect or poor installation, inadequate servicing, or maladjustment of the gas or water used.
- b) Any defects in the system to which the appliance is connected.
- c) Any deterioration or maladjustment following changes in the nature or pressure of the gas or the water used, or a change in the characteristics of the electrical supply voltage.

Notification of any fault should be made to the appliance installer. No repairs should be undertaken upon the



appliance, intending it to be covered by the product guarantee without prior authorisation from Saunier Duval.

IMPORTANT : The appliance serial number must be quoted on all correspondence/contact made with Saunier Duval.

This guarantee is in addition to your statutory and other legal rights, which will not be excluded or diminished by the return of the guarantee registration card.

Servicing, all you need to know

To ensure the continued efficient and safe operation of the appliance it is recommended that it is checked and serviced as necessary at regular intervals. The frequency of servicing will depend upon the particular installation conditions and usage, but in general once a year should be enough. Refer to Section «Routine Cleaning and Inspection».

If this appliance is installed in a rented property there is a duty of care imposed on the owner of the property by

the current issue of the Gas Safety (Installation and Use) Regulations, section 35. Servicing/maintenance should be carried out by a competent person in accordance with the rules in force in the countries of destination.

To obtain service, please call your installer or Saunier Duval service using the telephone number on the back cover of this booklet.

Please be advised that the 'Benchmark' logbook



should be completed by the installation engineer on completion of commissioning and servicing.

All CORGI Registered Installers carry a CORGI ID card, and have a registration number. Both should be recorded in your boiler Logbook. You can check your installer is CORGI registered by calling CORGI direct on: 01256 372300.

Cleaning

The boiler casing can be cleaned with a damp cloth followed by a dry cloth to polish. Do not use abrasive or solvent cleaners.

Boiler casing

CAUTION. Do not remove or adjust the casing in any way, as incorrect fitting may result in faulty operation. If in doubt, consult your installation/service company.



USERS

Control as a source of savings

Your Isofast boiler is factory set to operate within a customary installation.

Nevertheless, as many installations may incorporate specific features, feel free to contact your installer who will be able – by adapting the parameters of the boiler (maximum temperature and/or maximum power of the heating system) - to warrant you the best operating performance of your installation.

These settings being made, you still have the possibility of selecting the ambient temperature to suit your own requirements not only when you are at home, but also during nighttime or when you are out

All these settings are achieved from the room thermostat supplied together with your boiler: if you accurately determine the temperatures that best suit to your needs, you will make significant savings in terms of gas consumption.

Essential adjustments to the wireless room thermostat :

- A** – Setting the time
- B** – Setting the date

The thermostat's weekly programme functions enable you :

C – To activate or deactivate the heating function.

D – To have a **standard weekly programme** by activating the programme pre-set at the factory.

E – To **bypass** the current programme, temporarily, to increase or lower the temperature at any time during the day.

F – To set up a custom programme for each day of the week, with 2 temperature levels, for example:

- COMFORT for the periods you are present and.
- ECO at night or when you are away.

G – To have the same temperature **24 hours a day** by deactivating the programme.

H – To leave on **holiday**, determining the desired temperature according to the date you leave and when you return.

I – To select the temperature of your **domestic hot water** from 38°C to 60°C. However, keeping the temperature below 50°C, reduces gas consumption and provides good protection against scalds.

J – To prevent undesired alterations to your settings by **locking** the thermostat's buttons.

K – To be **informed of any operating faults** in the boiler and be instructed in the procedure to follow.



- 1 - Display.
- 2 - Fault indicator.
- 3 - Return to previous menu
- 4 - Confirm OK.
- 5 - Access to the menus.
- 6 - Menu scrolling
- 7 - Changing the mode
- 8 - Wall bracket
- 9 - Mains power plug

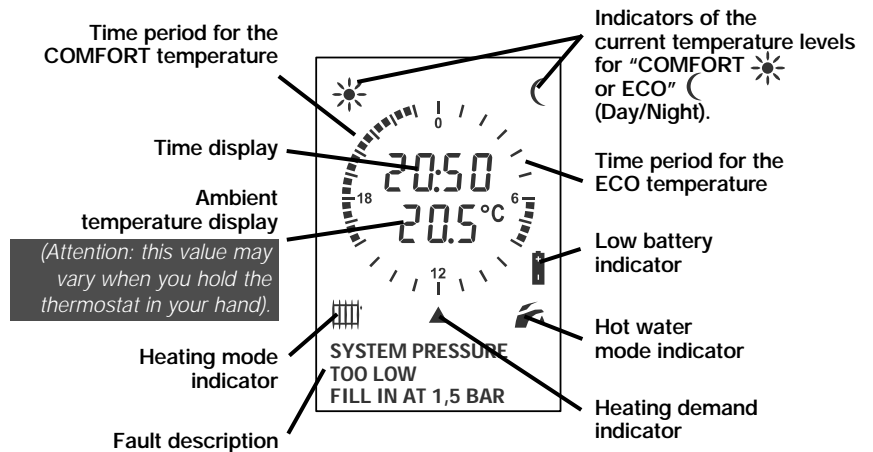

USERS

Control as a source of savings

(A) and (B) Settings for the time and the date

Progress of the operations : Please note that pressing button **(C)** at any time takes you back to the previous step

1 - Accessing the user menu

- Press **(MENU)** to call up the next menu:
 - ▶ SET COMFORT T_i
 - SET ECO T_i
 - PROGRAMME
 - SET HOT WATER T_i
 - ON/OFF HEATING
 - HOLIDAYS
 - SET TIME
 - SET DATE

2 - Setting the time

- Use the **▲** **▼** buttons to select the "Set time" menu:

▶ SET TIME → **(OK)** → 17:23 → **▲** **▼** + **(OK)**

3 - Setting the date

- Use the **▲** **▼** buttons to select the "Set date" menu:

▶ SET DATE → **(OK)** → TUE 14/JUA/ 03 → **▲** **▼** + **(OK)**

(C) Activating/deactivating the heating function

- Press **(MENU)** + **▲** **▼** to select the "ON/OFF heating" menu:
 - PROGRAMME
 - SET HOT WATER T_i
 - ON/OFF HEATING → **(OK)**
 - ...

1 - Activate the heating

▶ ON/OFF HEATING → **(OK)** → OFF → **▲** **▼** → ON → **(OK)**

2 - Deactivate the heating

▶ ON/OFF HEATING → **(OK)** → ON → **▲** **▼** → OFF → **(OK)**

(D) Activating the initial programme

Progress of the operations: Please note that pressing button **(C)** at any time takes you back to the previous step.

1 - Activating the weekly programme

- Press **(PROG)**, the room thermostat shows this display:

- Pressing **(PROG)** reverses ON and OFF mode every time

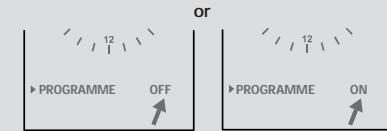

- When the ON mode appears, wait 5 seconds for the display to return to normal position and automatically validate the selection.

2 - Accessing the initial programme

- Press **(MENU)** + **▲** **▼** to select the "Programme" menu:
 - SET COMFORT T_i
 - SET ECO T_i
 - PROGRAMME → **(OK)**
 - ...

▶ PROGRAMME → **(OK)** + **▲** **▼** → ▶ INITIAL PROGRAMME → **(OK)**
MONDAY

- Exit from the menu by pressing **(C)**, which initiates the standard weekly programme pre-set at the factory :



(E) Temporarily bypassing the weekly programme

- Pressing one of the scroll buttons **▲** **▼** calls up the menu for setting the ambient temperature :

▶ SET ROOM T_i → **▲** **▼** → ▶ SET ROOM T_i → **(OK)**
22°C 20°C
Confirm by pressing **(OK)**

This setting is automatically cancelled when the programme changes to Eco or Confort temperature level.

USERS

Control as a source of savings

F Setting the custom weekly programme

Progress of the operations : Please note that pressing button **C** at any time takes you back to the previous step.

1 - Activating the weekly programme

• Press **PROG**, the room thermostat shows this display:

• Pressing **PROG** reverses ON and OFF mode every time.

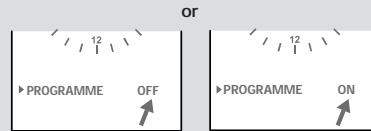

• When the ON mode appears, wait 5 seconds for the display to return to normal position and automatically validate the selection.

2 - Access to the user menu

• Press **MENU** to call up the next menu:

► SET COMFORT T_i
SET ECO T_i
PROGRAMME
...

3 - Setting the Comfort temperature

► SET COMFORT T_i → **OK** → 19.0;C → **▲** → 20.0;C → **▼** → 19.5;C → **OK**
(to set the desired temperature during the day)

4 - Setting the Eco temperature

► SET ECO T_i → **OK** → 16.0;C → **▲** → 17.0;C → **▼** → 16.5;C → **OK**
(to set the desired temperature during the night or while you are away)

5 - Programme

► PROGRAMME → **OK** → MONDAY → **OK** → ► MODIFY → **OK** →
(to allocate time periods for the Comfort and Eco temperatures)
TUESDAY
WEDNESDAY
THURSDAY
FRIDAY
SATURDAY
SUNDAY
INITIAL PROGRAMME

The squares indicate the time periods when the boiler will provide the COMFORT temperature level
(e.g.: 19.5°C between 4 PM and 11 PM and 6 AM and 8 AM)



The blanks indicate the time periods when the boiler will provide the ECO temperature level.
(e.g.: 16.5°C between 8 AM and 4 PM and 11 PM and 6 AM)

This symbol indicates the mode authorising additional operating periods at the stated COMFORT temperature (black squares) using the buttons **▼/▲**

Press **PROG** to switch from COMFORT to ECO temperature

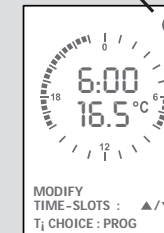
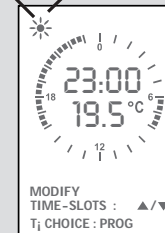

This symbol indicates the mode authorising deletion of black squares to set up operating periods at the stated ECO temperature using the buttons **▼/▲**

E.g. :
In the case of the illustration opposite, each press of the button **▲** adds a square from 11 PM onwards, corresponding to an extra 30 minutes heating at 19.5°C.

E.g. :
In the case of the illustration opposite, each press of the button **▲** adds a blank from 6 AM onwards, corresponding to an extra 30 minutes heating at 16.5°C.

• Press **OK** to confirm the parameters you have set for the day.

• Follow the same procedure for every day of the week or use the duplication function, as explained below.

Duplicating a programme

• To save time, you can copy the parameters you have set onto another day via the menu :

► MONDAY → **OK** → ► MODIFY → **OK** → ► MONDAY → **OK**
TUESDAY COPY TO TUESDAY

USERS

Control as a source of savings

G Setting the heating temperatures outside Programme mode

Progress of the operations : Please note that pressing button **C** at any time takes you back to the previous step.

1 - Deactivating the weekly programme

- Pressing **PROG** activates or deactivates the programme mode each time :

PROG → PROGRAMME ON → **PROG** → PROGRAMME OFF

- Retain the **PROGRAMME OFF** position. After 5 seconds, the display returns to its normal position and automatically validates this selection.

2 - Access to the user menu

- Press **MENU** to call up the next menu : ▶ SET ROOM T_i ...

3 - Setting the ambient temperature

- ▶ SET ROOM T_i → **OK** → 19.0°C → **▲▼** →

20.0°C
19.5°C
18.5°C

 → **OK**
- (to set the constant temperature desired)

H Holiday programme

1 - Access to the user menu

- Press **MENU** + **▲▼** to call up the next menu : ▶ SET HOT WATER T_i ON/OFF HEATING HOLIDAYS ...

2 - Activating the Holiday programme

- Determine the temperatures you wish according to your departure and return dates.

- ▶ HOLIDAYS → **OK**

▶ START DATE
▶ END DATE
▶ SET ROOM T _i
▶ CANCEL
- ▲▼** + **OK**

I Setting the hot water temperature

Progress of the operations : Please note that pressing button **C** at any time takes you back to the previous step.

1 - Access to the user menu

- Press **MENU** + **▲▼** to call up the next menu : ▶ SET ECO T_i PROGRAMME ▶ SET HOT WATER T_i ...

2 - Setting the hot water temperature

- ▶ SET HOT WATER T_i → **OK** → 50°C → **▲▼** →

52°C
51°C
49°C

 → **OK**
- (to set the hot water to the desired temperature)

J Locking/unlocking the thermostat's buttons

- Holding down the **C** and **OK** buttons simultaneously for 3 seconds locks the room thermostat's buttons.







Press for 3 seconds

- Follow the same procedure to unlock the buttons.

USERS

Control as a source of savings

K **Fault indicators**

- If a fault occurs, the red lights  on the boiler and on the room thermostat flash and a pictogram is displayed on the thermostat: , , ,  or 
- Press the **OK** button on the thermostat:

Fault level 1

- The thermostat shows the procedure to follow:

SYSTEM PRESSURE
TOO LOW
FILL IN AT 1.5 BAR

- At the same time, the boiler's screen shows the code for the fault:

21

Fault level 2

- The thermostat asks you to call your After-Sales service engineer, informing him of the fault code flashing on the boiler to assist in his diagnosis.

FLOW RATE FAULT
CALL AFTERSALES
TEL 00 00 00 00 00

- At the same time, the boiler's screen shows the code for the fault:

23

Glossary for the user menu

- Set room T°**
Setting the ambient temperature when the programme has not been activated (Programme inactive).
- Set comfort T°**
Setting the Comfort temperature for the periods set in "Programme" menu.
- Set eco T°**
Setting the reduced temperature for the periods set in the "Programme" menu.
- Programme**
Allocating operating periods for Comfort and Eco temperature for each day of the week. **In the morning, for example, you are recommended to start heating approximately 1 hour before you get up.**
- Outdoor T°**
Displaying the external temperature when an external sensor is installed.
- Set hot water T°**
Setting the hot water temperature.
- ON/OFF heating**
Starting / stopping heating
On = Heating + hot water
Off = Hot water only
Outdoor T° = displayed when an external sensor is connected. When "Driven by ext. T°" is selected, the boiler automatically cuts off the heating when the temperature is higher than 18°C (factory setting).
- Set radiator T° or Floor heating T°**
Displayed if your installer has selected "consigne "manual" in the "heating control" menu under the "installer" menu
- Holidays**
Setting the ambient temperature for while you are away.
- Set time**
Setting the time.
- Set date**
Setting the date.

INSTALLERS

General Information

IMPORTANT NOTICE

The boiler and pipes are supplied in one pack, the flue is supplied separately. This boiler is factory set for use only on G20 natural gas.

Where no British Standards exists, materials and equipment should be fit for their purpose and of suitable quality and workmanship. Refer to Manual Handling Operations, 1992 regulations.

The installation of this boiler must be carried out by a competent person in accordance the rules in force in the countries of destination.

Manufacturer's instructions must not be taken as overriding statutory requirements.

Sheet Metal Parts

WARNING: When installing the appliance, care should be taken to avoid any possibility of personal injury when handling sheet metal parts.

Statutory Requirements

The installation of the boiler MUST be carried out by a competent person in accordance with the relevant

requirements of the current issue of : Manufacturer's instructions, supplied.

The Gas Safety (Installation and Use) Regulations, The Building Regulations, The Building Standards (Scotland) Regulations (applicable in Scotland), local Water Company Bylaws, The Health and Safety at Work Act, Control of Substances Hazardous to Health, The Electricity at Work Regulations and any applicable local regulations. Detailed recommendations are contained in the current issue of the following British Standards and Codes of Practice, BS4814, BS5440 Part 1 and 2, BS5449, BS5546, BS6700, BS6798, BS6891 and BS7074 Part 1 and 2, BS7478, BS7593, BS7671.

We also suggest that you have to hand a copy of the British Gas publication, "Guidance Notes for the Installation of Domestic Condensing Boilers".

Manufacturer's notes must not be taken as overriding statutory obligations.

Certification

This boiler certificated to the current issue of EN 483 for

performance and safety. It is important that no alteration is made to the boiler, without permission, in writing, from Saunier Duval.

Any alteration that is not approved by Saunier Duval., could invalidate the warranty and could also infringe the current issue of the Statutory Requirements.

Electrical Supply

All system components shall be of an approved type and all wiring to current I.E.E. wiring regulations. External wiring must be correctly earthed, polarised and in accordance with the relevant standards.

In GB this is BS 6891. In IE this is the current edition of I.S.813 "Domestic Gas Installations". The boiler must be connected to a permanent 230V ac, 50Hz supply. Connection of the whole electrical system of the boiler, including any heating controls, to the electrical supply must be through one common isolator and must be fused 3 Amp maximum.

Wiring to the boiler must be PVC 85°C insulated cable, not less than 0.75mm² (24/0.20mm).

Dimensions

The boiler is delivered in one package :
the boiler itself, the wireless thermostat, the fixing bracket, the template and pipe connections .

The different packages relating to the flue system will be ordered depending on the actual configuration of the installation

ATTENTION: DO NOT FORGET TO RECOVER THE ROOM THERMOSTAT placed in a polystyrene case in the bottom of the package.

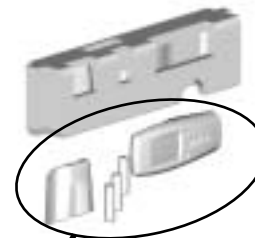

The "as delivered" package consists of :
- 1 wireless thermostat
- 1 fixing bracket
- 3 x 1.5 V alkaline battery cells type LR6
- 1 access cover to the battery cells

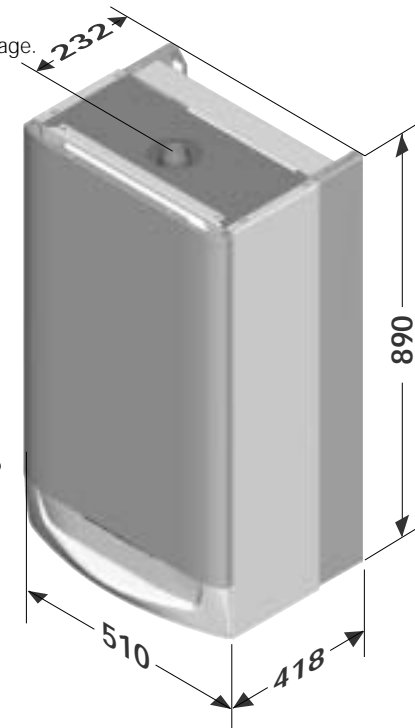

Isofast		F 35 E	
Net weight	(kg)	52	
Gross weight	(kg)	60	

INSTALLERS

Technical Data Isofast

Heating		F 35 E
Heating output at 80°C/60°C (P)	adjustable (kW)	from 7,6 to 28
	(BTU/H)	from 25,930 to 95,536
Heating input min. (Q)	(kW)/(BTU/H)	8 / 27,296
Heating input max. (Q)	(kW)/(BTU/H)	28,6 / 97,583
SEDBUK efficiency	(%)	?
Heating output at 50°C/30°C	adjustable (kW)	from 8,6 to 30,6
Maximum heating temperature	(°C)	80
Minimum heating temperature	(°C)	22
Expansion vessel charge pressure	(bar)	0,5
Maximum system capacity at 75°C	(l)	215
Safety valve, maximum service pressure (PMS)	(bar)	3,0

Hot water		F 35 E
Heating output (P)	adjustable from... (kW)/(BTU/H)	34,2 / 116,690
	to... (kW)/(BTU/H)	7,6 / 25,931
Maximum hot water temperature	(°C)	60
Threshold flow rate	(l/min.)	1
Specific flow rate (D) (for 30°C temp rise)	(l/min.)	16,3
Storage capacity	(l)	4
Expansion valve setting	(bar)	10
Minimum operating pressure	(bar)	0,7
Maximum operating pressure (P _{MW})	(bar)	10

Combustion		F 35 E
Product outlet diameter	(mm)	60
Fresh air inlet diameter	(mm)	100
Fresh air flow rate (1013 mbar - 0°C)	(m³/h)	43
Product outlet flow rate	(g/s)	15,3
Product outlet temperature	(°C)	68
Values of product outlet	CO (ppm o mg/kWh)	100 or 176
	CO ₂ (%)	9,2
	NO _x (ppm o mg/kWh)	21,1 or 37,3

Gas category	F 35 E
	I12H3P

Electricity		F 35 E
Electrical supply	(V)	230
Electrical rating	(A)	0,9
Maximum absorbed power	(W)	206
IP classification		IPX4D
Class		1

Natural Gas (G 20)		F 35 E
Ø burner injector	(mm)	5,65
inlet pressure	(mbar)	20
Sanitary flow rate at maximum input	(m³/h)	3,62
Heating flow rate at maximum input	(m³/h)	3,02
Flow rate at minimum input	(m³/h)	0,85

Gas Supply

The gas installation must be in accordance with the relevant standards. In GB this is BS6891. In IE this is the current edition of I.S.813 "Domestic Gas Installations".

The supply from the governed meter must be of adequate size to provide a steady inlet working pressure of 20mbar (8in wg) at the boiler.

On completion, test the gas installation for soundness using the pressure drop method and suitable leak detection fluid, purge in accordance with the above standard.

Technical Data

All dimensions are given in millimetres (except as noted).

The data label is positioned on the inner door.

The Seasonal Efficiency Domestic Boilers UK (SEDBUK) is Band 'A'.

The value is used in the UK Government's Standard Assessment Procedure (SAP) for energy rating of dwellings. The test data from which it has been calculated has been certified by B.S.I.

INSTALLERS

Technical Data

Curve output/pressure

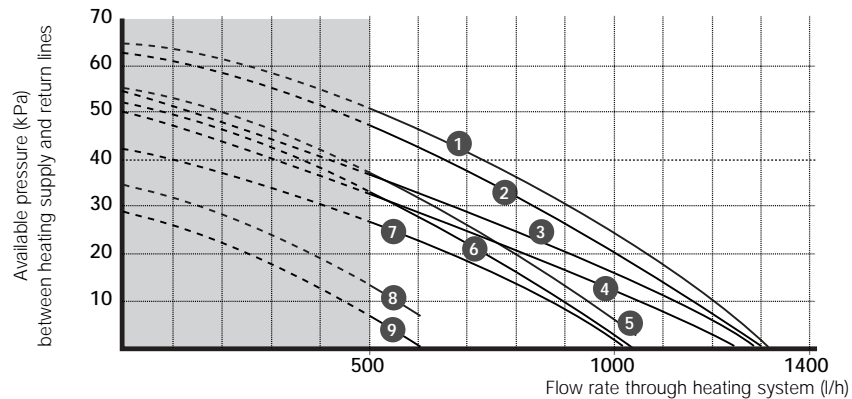

- | | | |
|-----------|---|--------------------|
| Speed III | 1 | By-pass fully shut |
| | 2 | Open 1/4 turn |
| | 3 | Open 1/2 turn |
| | 4 | Open 2 turns |
| Speed II | 5 | By-pass fully shut |
| | 6 | Open 1/4 turn |
| | 7 | Open 1/2 turn |
| Speed I | 8 | By-pass fully shut |
| | 9 | Open 1/2 turn |

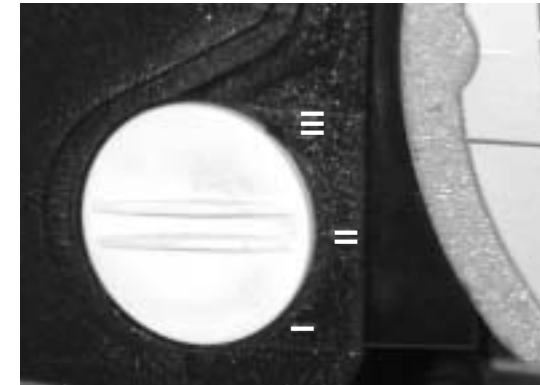

NB : Factory setting : Speed II

Bypass

The Isofast boiler has a built-in bypass. This must be adjusted according to the requirements of the system, refer to the flow rate pressure curve. The boiler is supplied with the built-in bypass open a half a turn. It is adjusted by turning the bypass screw (a). Turn the screw clockwise to close the bypass. When using thermostatic radiator valves (TRVs) on all of the radiators, it is essential that a separate, adjustable bypass of 15 mm minimum diameter is fitted between the flow and return

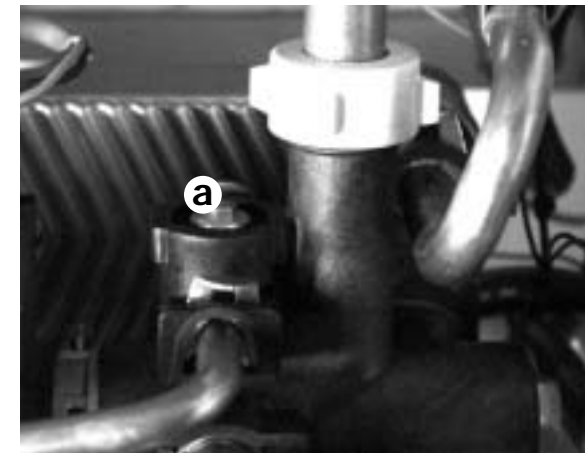

of the heating circuit. Any bypass must be fitted before system controls.

INSTALLERS

Boiler components

Isofast F 35 E

- a - Flue outlet
- b - Overheat safety thermostat.
- c - Combustion chamber
- d - Expansion vessel
- e - Air/Gas mixture inlet
- f - Ignition and control electrode
- g - Fan
- h - Gas control valve
- i - Ignition module
- j - Condensate drain
- k - Heating flow thermistor
- l - Heating return thermistor
- m - Water flow sensor
- n - Water pressure sensor
- o - Pump
- p - Filter on cold water inlet
- q - Domestic plate to plate heat exchanger
- r - Discharge safety valve 10 bar
- s - Discharge safety valve 3 bar
- t - Filling system
- u - Drain cock
- v - Room thermostat plug
- w - Control panel

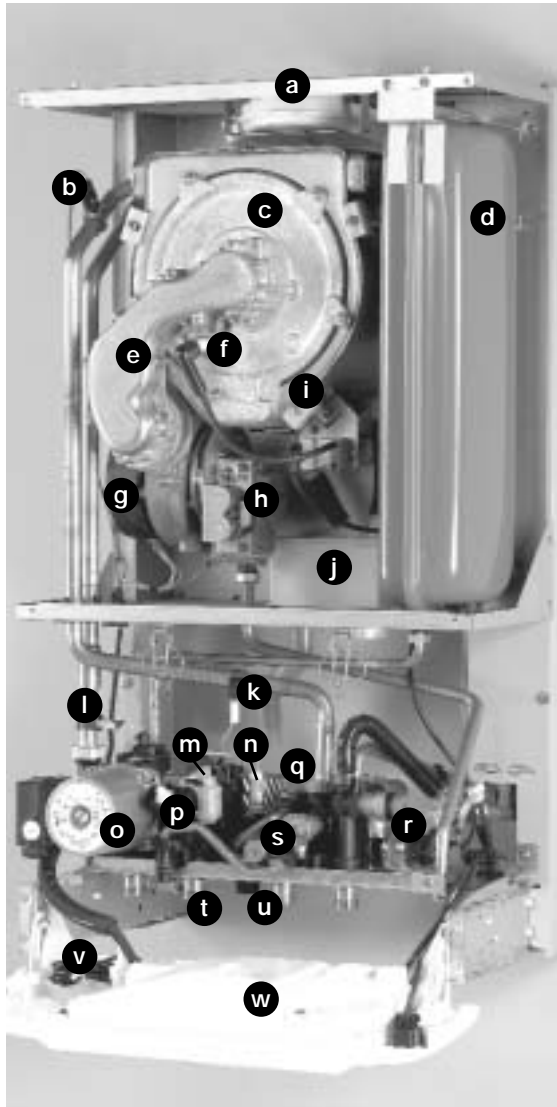

Schematic layout of boiler

Isofast F 35 E

- 1 - Flue outlet
- 2 - Main heat exchanger
- 3 - Burner
- 4 - Ignition and control electrode
- 5 - Fan
- 6 - Gas control valve
- 7 - DHW storage vessel
- 8 - Condensate drain
- 9 - Overheat safety thermostat.
- 10 - Temperature sensor for DHW storage vessel
- 11 - Expansion vessel
- 12 - Heating return thermistor
- 13 - Heating outlet thermistor
- 14 - Ignition module
- 15 - Pump
- 16 - Water pressure sensor
- 17 - Domestic plate to plate heat exchanger
- 18 - Three way valve
- 19 - Heating element
- 20 - Drain cock
- 21 - Water flow sensor
- 22 - Discharge safety valve 3 bars
- 23 - DHW temperature sensor
- 24 - Discharge safety valve 10 bar

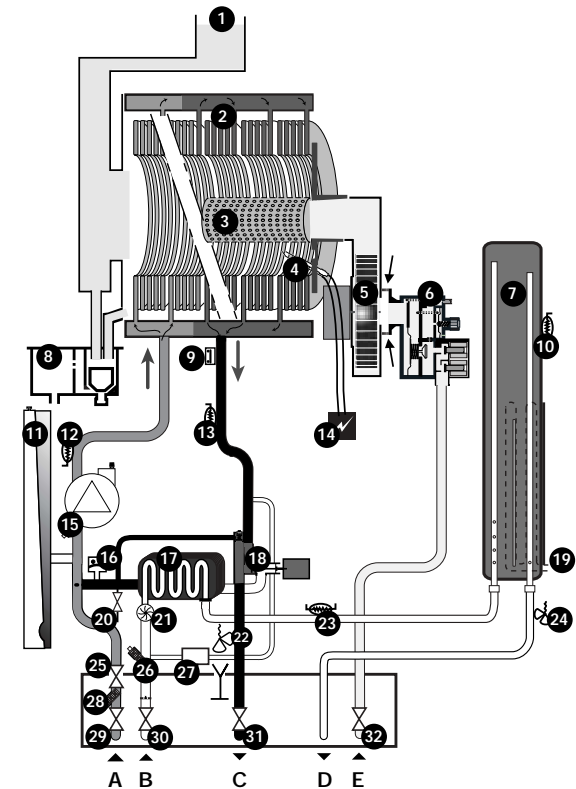

- 25 - Isolating valve
- 26 - Filter on cold water inlet
- 27 - Filling system
- 28 - Filter on heating circuit
- 29 - Isolating valve
- 30 - Isolating valve
- 31 - Isolating valve
- 32 - Isolating valve
- A - Heating return
- B - Cold water inlet
- C - Heating flow
- D - Domestic hot water outlet
- E - Gas

INSTALLERS

Boiler location

- This boiler is not suitable for outdoor installation.
- This boiler may be installed in any room, although particular attention is drawn to the installation of a boiler in a room containing a bath or shower where reference must be made to the relevant requirements. In GB this is the current I.E.E. WIRING REGULATIONS and BUILDING REGULATIONS. In IE reference should be made to the current edition of I.S.813 "Domestic Gas Installations" and the current ETCl rules.

- The boiler should be positioned so that at least the minimum operational and servicing clearances are provided, see diagram opposite. Additional clearances may be beneficial around the boiler for installation and servicing. For flue installations where external access is not practicable, consideration should be given for the space required to insert the flue internally, which may necessitate clearance larger than those specified in diagram.

- If the boiler is to be

installed in a timber frame building it should be fitted in accordance with the Institute of Gas Engineers document IGE/UP/7/1998. If in doubt seek advice from the local gas undertaking or Saunier Duval.

- The boiler is room sealed, so when it is installed in a room or space, a permanent air vent is not required.
- Due to the high efficiency and hence low casing temperature of this boiler, cupboard or compartment ventilation is not necessary.

Leave existing air vents. A template is supplied with the fixing bracket. Position setting of the assembly shall be performed in compliance with the indications shown on the template. Use two or three screws for the fixing bracket.

The mechanical characteristics of the screws shall – at least – meet the requirements specified on the sketches below. Also, they shall be suited to the characteristics of the carrier wall.

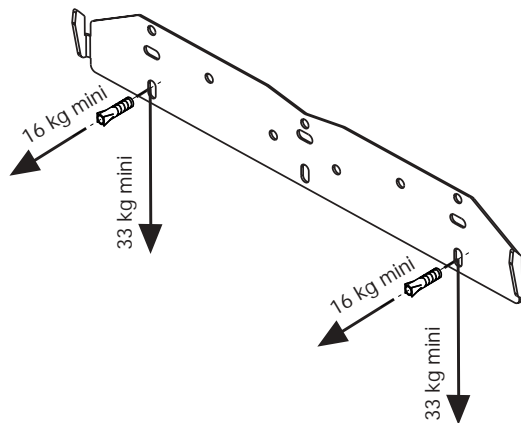

If the boiler is not immediately installed, protect the different

couplings so that no plaster or paint could jeopardize the tightness of subsequent

connections.

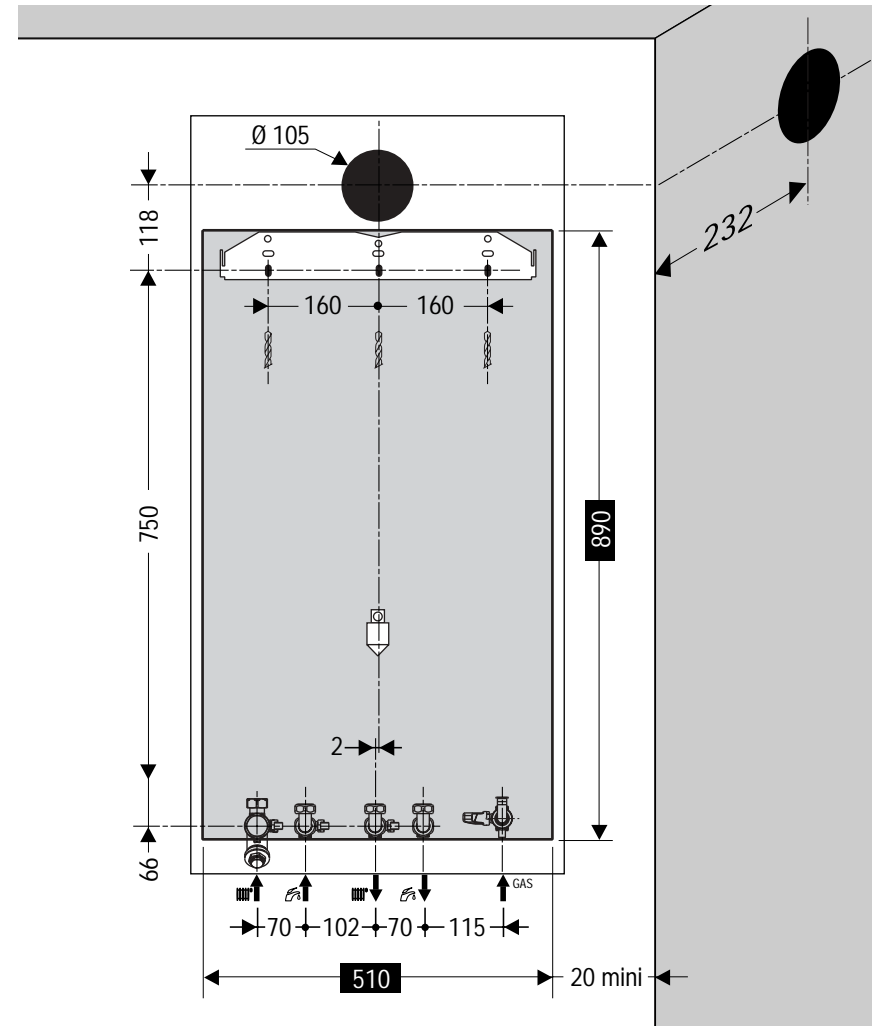

INSTALLERS

Flue location and Ventilation

Warning notice :

Use only flue accessories developed for Saunier Duval condensing boilers.

Flue Position and Length

The standard horizontal flue is fitted onto the top of the boiler using the flue elbow. See diagrams to determine whether a standard flue can be used.

An elevated flue system can be installed with the addition of a vertical flue adapter, extension kits and elbow, see section flue options.

When extension pipes are used the flue system must be designed to have a continuous fall to the boiler of at least 3% to allow condensate to run back into the boiler and out via the drain.

Internal Flue Installation

The flue can be installed from inside the building, when access to the outside wall face is not practicable.

Additional accessories are available.

See Saunier Duval "Flue Options Guide" for configurations available.

Minimum siting dimensions for fanned flues terminals portions

Horizontal flues

A - directly below an opening, air brick, opening windows	.300
B - above an opening, air brick, opening windows	.300
C - horizontally to an opening, air brick, opening windows	.300
D - below gutter, drain/soil pipe	.25
E - below eaves	.25
F - below a balcony or car port	.25
G - from vertical drain pipes and soil pipes	.25
H - from internal/external corners	.25
H* - to a boundary alongside the terminal	.300
I - above adjacent ground or balcony level	.300
J - from surface or a boundary facing the terminal	.600
K - facing terminals	.1200
L - from opening (door/window) in car port into dwelling	.1200
M - vertical from a terminal	.1500
N - horizontally from a terminal	.300

Vertical flues

P - from another terminal	.600
Q - above roof level	.300
R - from adjacent opening window	.1000
S - from adjacent wall to flue	.300

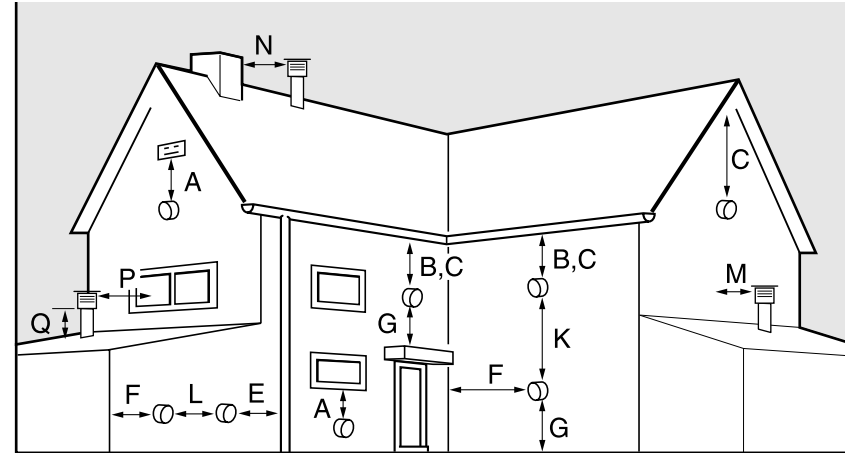

UNDER CAR PORT etc.

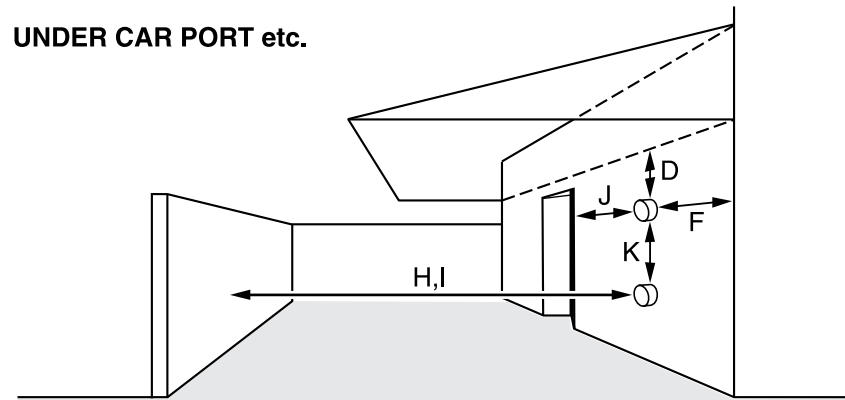

H* and J* : These dimensions comply with the building regulations, but they may need to be increased to avoid wall staining and nuisance from plumbing depending on site conditions.

INSTALLERS

Flue location and Ventilation

Horizontal flues (installation type C13)

The maximum head loss is reached with an elbow and flue system length (L) of 10 m.

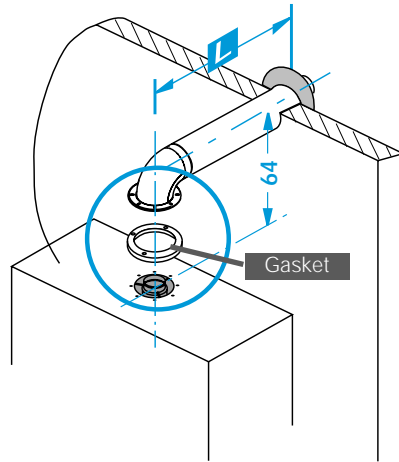

The flue system pipes must feature a slope of 3% towards the boiler in order to recover any condensates.

Attention : The flue system terminal supplied by Saunier Duval already integrates this slope. Therefore, it shall be

applied to any flue system extensions.

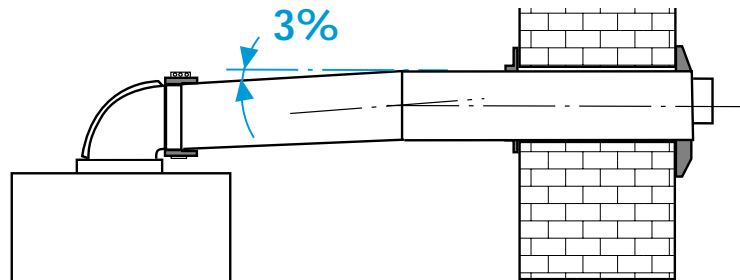

• Terminal Position

The minimum acceptable siting dimensions for the terminal from obstructions, other terminals and ventilation openings are shown in **page 29**. For Ireland the minimum distances for flue terminal positioning must be those detailed in I.S.813 "Domestic Gas Installations".

The terminal must be exposed to the external air, allowing free passage of air across it at all times.

Being a condensing boiler some pluming may occur from the flue outlet. This

should be taken into consideration when selecting the position for the terminal.

It may be necessary to increase dimensions H & J if there is a risk that the boiler products could stain any adjoining surface.

Carports or similar extensions of a roof only, or a roof and one wall, require special consideration with respect to any openings, doors, vents or windows under the roof. Care is required to protect the roof if the carport comprises of a

roof and two or more walls, seek advice from the local gas supply company before installing the boiler.

• Terminal Guard

A terminal guard is required if persons could come into contact with the terminal or the terminal could be subject to damage. If a terminal guard is required, it must be positioned to provide minimum of 50mm clearance from any part of the terminal and be central over the terminal.

INSTALLERS

Heating system

General

The boiler is for use only with sealed central heating systems. The safety valve is an integral part of the boiler and it cannot be adjusted. The digital readout on the controls fascia indicates the system pressure when there is no central heating demand. The circulation pump is integral with the boiler.

Expansion vessel

The boiler has an integral expansion vessel with a capacity of 10 litres, with a charge pressure of 0.5 bar. **Note** : The expansion vessel volume depends on the total water system volume and the initial system design pressure. Guidance on vessel sizing is also given in the current issue of BS5449 and BS7074 Part 1, for IE refer to the current edition of I.S.813 "Domestic Gas Installations".

Flow rate

If it is necessary to alter the flow rate, the system can be fitted with a lockable balancing valve in the main flow or return pipes shown as valve "A" in diagram. The flow rate through the boiler must not be allowed to fall below 14 l/min.

Bypass

The boiler is fitted with an adjustable automatic bypass. Ensure that under no circumstances does the flow rate drop below 14l/min.

The installation of the boiler must comply with the requirements of the current issue of BS6798, in Ireland, refer also to the current edition of I.S.813 "Domestic Gas Installations".

In GB it is necessary to comply with the Water Supply (Water Fittings) Regulations 1999 (for Scotland, the Water Byelaws 2000, Scotland).

To comply with the Water regulations your attention is drawn to : The Water Regulations guide published by the Water Regulations Advisory Service (WRAS) gives full details of the requirements.

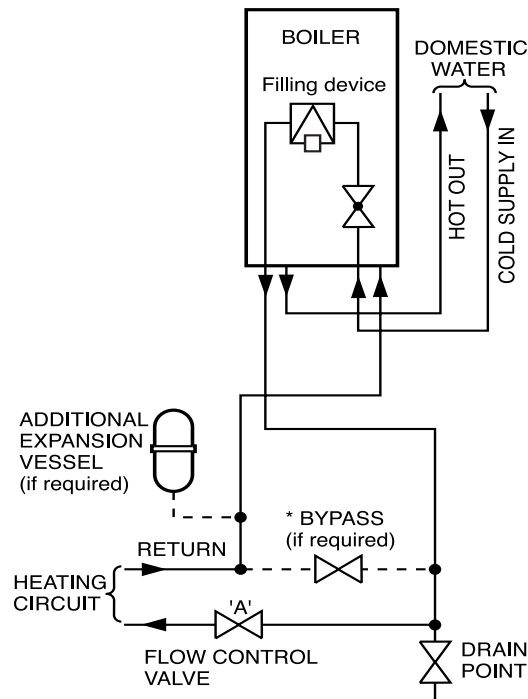

Heating system

In IE the requirements given in the current edition of I.S.813 "Domestic Gas Installations" and the current Building Regulations must be followed.

Water treatment

In the case of an existing installation, it is ESSENTIAL that prior to installing the new boiler the system is thoroughly flushed. For optimum performance after installation of a new system, the boiler and its associated central heating system should also be flushed. Flushing should be carried

out in accordance with BS7593: 1992 using a cleanser such as Sentinel X300 or X400, Fernox Superfloc or Salamander corrosion guard cleaner. For long-term corrosion protection, after flushing, an inhibitor suitable for stainless steel heat exchangers should be used, refer to the current issue of BS 5449 and BS 7593 on the use of inhibitors in central heating systems. Examples are Sentinel X100 Fernox or Salamander corrosion guard inhibitor.

Draining Tap

A draining tap must be provided at the lowest points of the system, which will allow the entire system to be drained. A drain tap for the appliance is provided as an integral part of the hydroblock, see diagram **page 24**. General - All domestic hot water circuits, connections, fittings must be in accordance with the relevant standards and water supply regulations.

Domestic Hot Water System

For GB: Guidance G17 to G24 and recommendation R17 to R24 of the Water Regulations Guide. For IE: The current edition of I.S.813 "Domestic Gas Installations".

Water Pressure

The maximum working pressure of the domestic hot water circuit is 10 bar. If the cold water supply pressure exceeds this, then

a pressure-reducing valve must be fitted in the supply to the boiler.

'Hard' Water Areas

The temperatures within the heat exchanger are limited by the boiler control system to minimise scale formation within the hot water pipework. However, in areas where the water is 'hard' (i.e. more than 200mg/litre), it is recommended that the hot

water setting is reduced and that a scale reducer is fitted. Refer to the manufacturer's instructions or consult the local water company for additional advice.

Domestic Water Flow Rate

The water flow rate is restricted to a maximum 16 l/min by a restrictor fitted on the cold water inlet.

INSTALLERS

Boiler installation

Prior to performing any operation, it is essential that the piping systems be flushed with a suitable product in order to eliminate any impurities such as fillings, weld spatters, oils and greases.

Such foreign materials could be driven into the boiler, and could impair its operation. NB: Solvents may cause damages to the piping system. Remove the wooden beam placed behind the boiler.

Appliance Connection

IMPORTANT: With regards to the Manual Handling Operations, 1992

Regulations, the following lift operation exceeds the recommended weight for a one man lift, refer to Manual Handling section, **on page 4**. The appliance will contain a small amount of water, place a water container beneath the boiler connections before removing the protective caps.

1 - Lifting the boiler into position, lean the top of the boiler slightly to the wall and position just above the hanging bracket.

2 - Lower the boiler slowly and engage onto the hanging bracket.

Connect isolating valves using washers and domestic flow restrictor supplied with the boiler.

3 - Do not forget to connect the blue extension on the filling tap, as shown on the picture below.

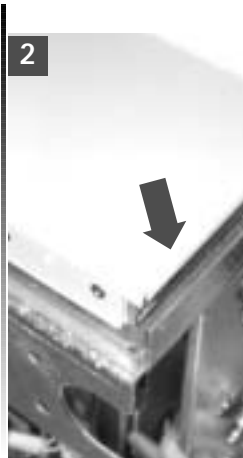
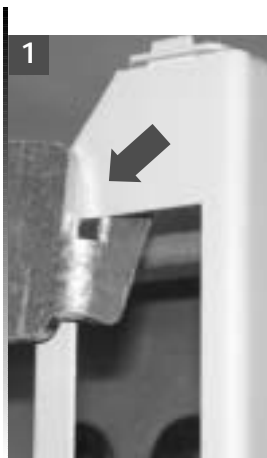

Piping installation

Make connections to boiler, gas, water and heating cocks with the tube assemblies supplied in piping pack as shown in the diagram below :

- A - Heating return with isolating tap (t) and (u),
- B - Cold water inlet with isolating tap (v) and water restrictor to 16 l/min,
- C - Heating flow with isolating tap (w),
- D - Domestic hot water outlet,
- E - Gas inlet with isolating tap (x).

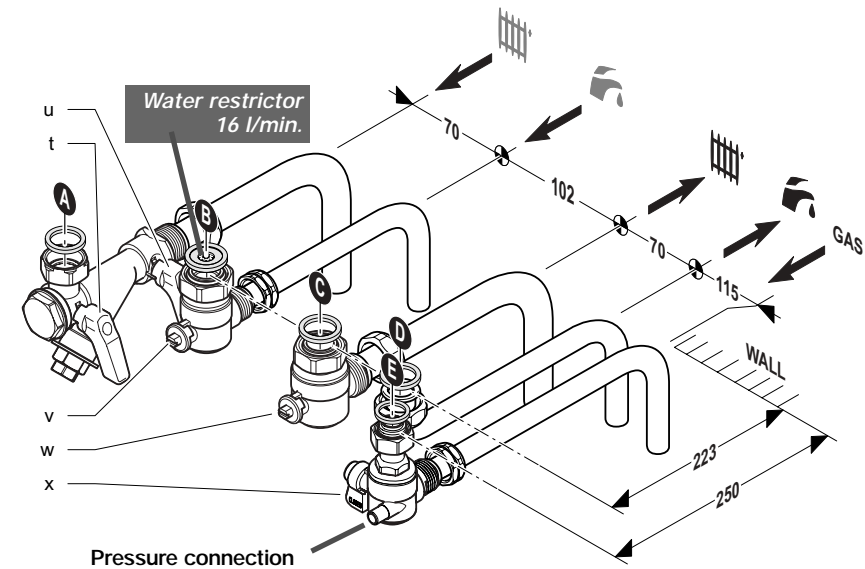

Gas Connection

Before connection check supply of local gas. Refer also to **page 18**. Do not subject the gas service cock to heat. Fit the sealing washer into the union nut and make good the connection to the gas service cock on the wall.

Make sure the on / off lever is accessible. The whole of the gas installation, including the meter, should be inspected, tested for soundness and purged in accordance with the current issue of BS6891 and in IE the current edition of I.S.813 "Domestic Gas Installations".

- A - C : Central heating Ø 22 mm
- B - D : Domestic hot water Ø 15 mm
- E : Gas supply Ø 15 mm

INSTALLERS

Piping installation

Water Connections

Flush out the domestic hot water and the heating systems before connecting to the boiler.
Make the connections to the domestic hot water and heating systems by fitting the sealing washers into the securing nuts and make good the connection to the isolating valves.
Do not subject the isolation valves to heat.
Make sure the drain point is accessible.

- The heating return coupling is equipped with a filter, accessible after removing the end nut.
- The proof-test pressure can be read on a pressure gauge screwed instead of the heating return coupling end nut (A).

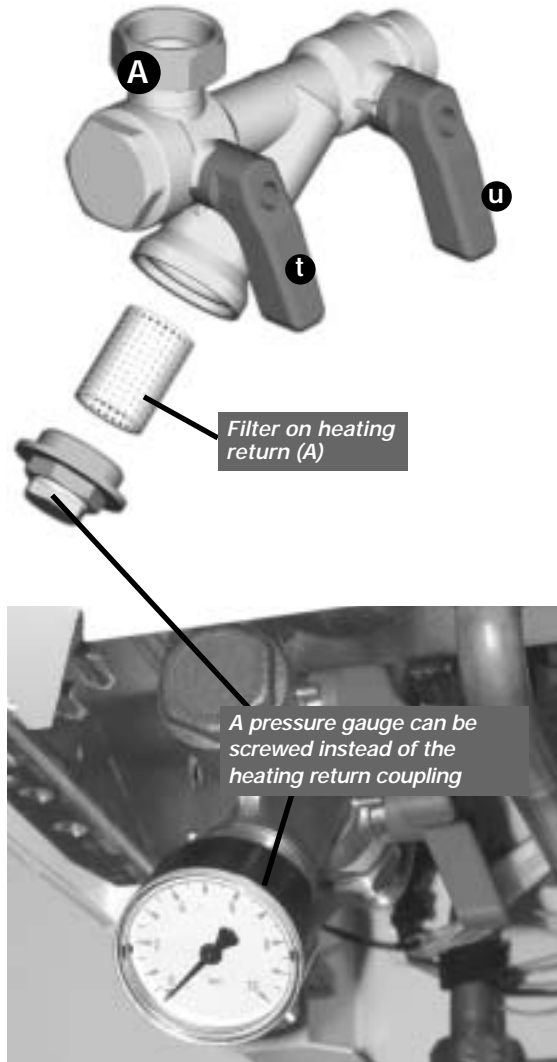

Safety Discharge Valve
The pipes from the safety discharge valves **S1** and **S2** must not discharge above an entrance, window or any type of public access area. Take the short safety discharge tube, union nut and seal, supplied loose in the boiler fittings pack and fit as shown in diagram below.
This must be extended, using not less than 15mm

o.d. pipe, to discharge, in a visible position, outside the building, facing downwards, preferably over a drain. The pipe must have a continuous fall and be routed to a position so that any discharge of water, possibly boiling, or steam cannot create any danger to persons, damage to property or external electrical components and wiring.

To ease future servicing it is advisable to use a compression type fitting supplied with the boiler to extend the safety discharge valve tube.

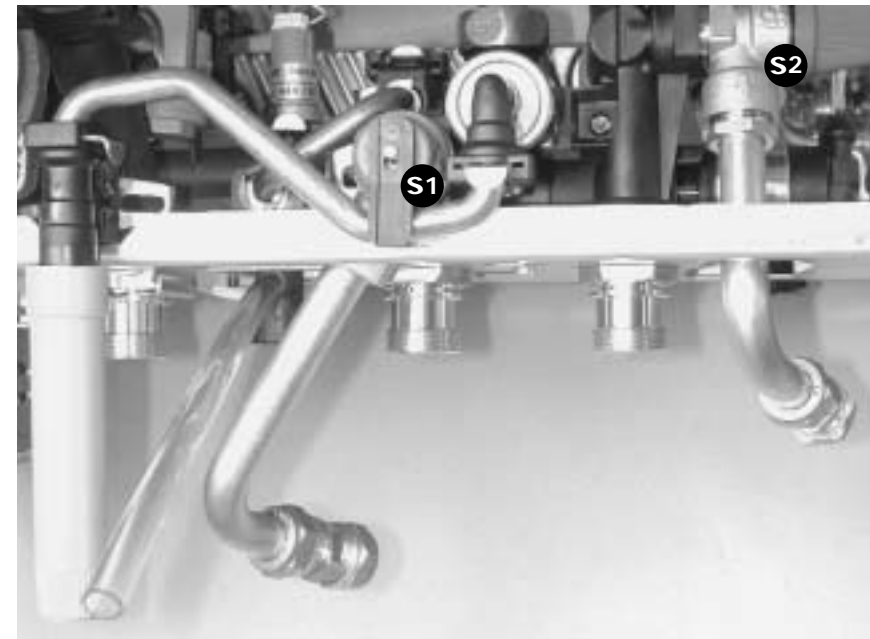

INSTALLERS

Piping installation

Connect the A elbow Ø 22 mm to a discharge system leading to the sewer, in compliance with the instructions below:

- Use a rigid PVC tube or a flexible silicon pipe resistant to condensate.
- The pipe must have a continuous fall.
- Do not use copper pipes

Important notice :

The float of the condensate recovery system also ensures fume tightness. Therefore, it is useless to add water in the condensate box.

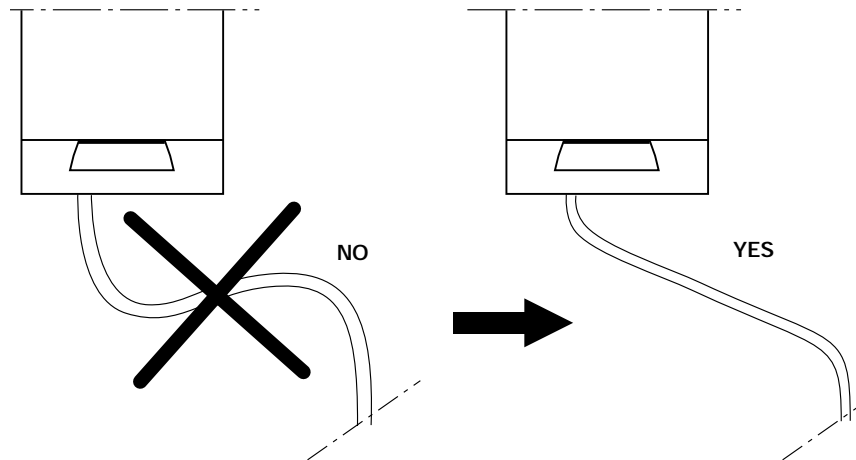
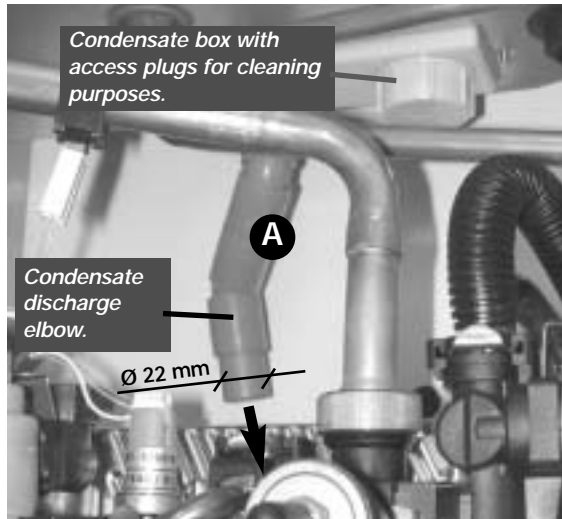

Electrical connection



WARNING : This appliance must be earthed.

This appliance must be wired in accordance with these instructions. Any fault arising from incorrect wiring cannot be put right under the terms of the Saunier Duval guarantee. All system components must be of an approved type.

Electrical components have been tested to meet the equivalent requirements of the BEAB. Do not interrupt the mains supply with a time switch or programmer. Connection of the whole electrical system and any heating system controls to the electrical supply must be through a common isolator.

Isolation should preferably be by a double pole switched fused spur box having a minimum contact separation of 3mm on each pole. The fused spur box should be readily accessible and preferably adjacent to the boiler. It should be identified as to its use.

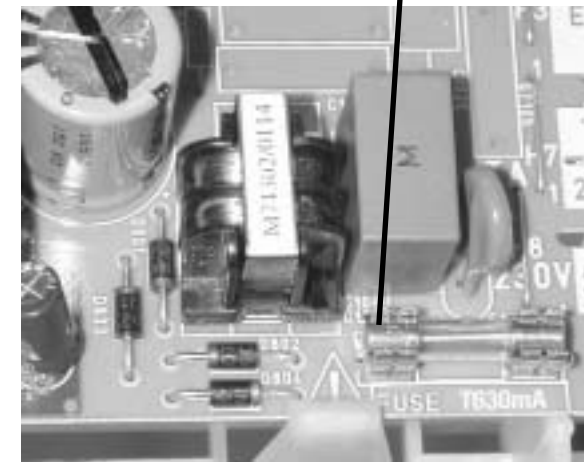

Mains Cable

Important: If a replacement supply cable is required it must be purchased from Saunier Duval.

- The 630 mA fuse of the PCB must be connected to the neutral.

INSTALLERS

Commissioning on boiler

Please ensure the "Benchmark" logbook is completed and left with the user .

The commissioning and first firing of the boiler must only be done by a qualified registered person.

Make sure that the boiler is connected to the electrical supply and the gas service cock is open.

Filling the system 1 to 8

1 Switch ON (I).



2 Open the isolating taps (t), (u), (v) and (w) on boiler: slot in line with the length of the valve

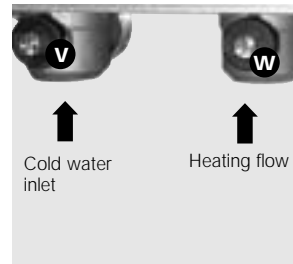
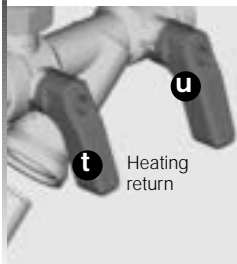

3 Undo cap on automatic air vent on top of pump and leave undone.



4 Fill the system until the pressure indicated on the display is between 1 and 2 bar. Close filling device.

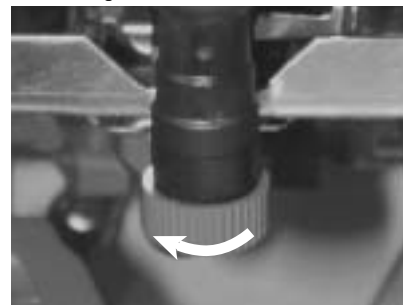

5 Bleed each radiator to remove the air, re-tighten bleed screws.



6 Leave the cap on the pump auto air vent open.

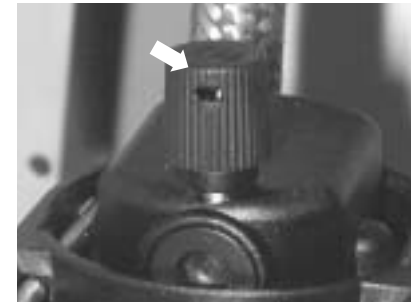

7 Open various hot water taps to bleed system.



8 Make sure the display indicates a system pressure of between 1 and 2 bar. Re-fill system as necessary.



INSTALLERS

Commissioning on boiler

Press the  key to operate the boiler without room thermostat.

- Adjust heating temperature to maximum.
- Allow the temperature to rise to the maximum value, with all radiator valves open. The temperature rise will cause release of the gases contained in the water of the central heating system.
- Gases driven towards the boiler will be automatically released through the automatic air vent.
- The gases trapped at the highest point of the system must be released by bleeding the radiators. Check the burner gas rate required, ten minutes from lighting. Refer to Data Label on electrical controls box. Should there be any doubt about the gas rate it should be checked at

the meter. On reaching maximum temperature, the boiler should be turned off and the system drained as rapidly as possible whilst still hot.

- Refill system to a pressure of between 1 and 2 bar and vent as before.
 - Restart boiler and operate until a maximum temperature is reached. Shut down boiler and vent heating system. If necessary, top up heating system and make sure that a pressure of at least 1 bar is indicated when system is COLD.
- Flush the domestic hot water system by opening the hot water taps for several minutes.

Instruct the User

- Instruct and demonstrate the lighting procedure and advise the user on the safe

and efficient operation of the boiler.

- Instruct on and demonstrate the operation of heating system control.
- Advise the user on the use and maintenance of any scale reducer and pass on any relevant instructional documents.
- Advise that to ensure the continued efficient and safe operation of the boiler it is recommended that it is checked and serviced at regular intervals. The frequency of servicing will depend upon the installation conditions and usage, but in general, once a year should be enough.
- Draw attention, if applicable, to the current issue of the Gas Safety (Installation and Use) Regulations, Section 35,

which imposes a duty of care on all persons who let out any property containing a gas appliance in the UK.

- The user shall not interfere with or adjust sealed components.
- It is the Law that any servicing is carried out by a competent person.
- Advise the user that, like all condensing boilers this appliance will produce a plume of condensation from the flue terminal in cool weather. This is due to the high efficiency and hence low flue gas temperature of the boiler.
- Advise the user of the precautions necessary to prevent damage to the system, boiler and the building, in the event of the heating system being out of

use during frost or freezing conditions.

- Advise the user that the permanent mains electrical supply SHOULD NOT be switched off, as the built in frost protection and pump/valve saver program would not be operable.
- Reminder, leave these instructions and the 'Benchmark' logbook with the user.
- For IE, it is necessary to complete a "Declaration of Conformity" to indicate compliance to I.S.813. An example of this is given in the current edition of I.S.813.

INSTALLERS

Commissioning on room thermostat

The wireless room thermostat (R.O.) has been specially developed for the Isofast.

- It is powered by 3 LR6 1.5V alkaline batteries.

• **The boiler's various functions are parametered from the room thermostat.**

Installing the room thermostat

- Fasten the bracket for the room thermostat on an internal wall approximately 1.50 m from the floor, in an area sheltered from direct sunlight and any source of interference, such as television, lamps, draughts, etc.

- Insert the batteries in the thermostat.

When commissioning for the first time

At initial commissioning stage, the boiler automatically shifts to manual mode (the control panel keys are lit, and the **P** key is blinking), thus meaning that the wireless room thermostat has not yet been acknowledged by the boiler. To do this :

- Open the control panel
- Locate connector **(A)** on the left-hand side and insert it in the thermostat for a few seconds as shown in the photo opposite.



When the red indicator light stops flashing, this shows that the boiler has recognised the thermostat.



Settings

Access to the boiler's technical data (reserved for use by the installers and After-Sales service personnel). This enables adjustments to be made and any malfunctions to be analysed :

The description below specifies the operations to be performed to make adjustments to an installation fitted with radiators or for a direct floor system. For other types of

installation (for example with a floor-heating system), follow the instructions in the appropriate accessories manual.

Your installation consists of a single radiator zone or direct floor system 1/3

Progress of the operations : Please note that pressing button **(C)** at any time takes you back to the previous step.

1 - Accessing the installer menu

- Connect connector **(A)** to the room thermostat as detailed on the previous page.

- Press **(MENU)** for 5 seconds to call up the following menu : **▶ INSTALLER MENU**
AFTERSALES MENU
FAULT HISTORY
BOILER DATA

- Select installer menu :

▶ INSTALLER MENU → **(OK)** + **(Up/Down)** → **▶ ACCESS CODE**
96 → **(OK)** → **▶ CHOOSE LANGUAGE**
INSTALLATION TYPE
RADIO SATELLITE
HEATING REGULATION
BOILER CONFIG.

2 - Select the language

▶ SELECT THE LANGUAGE → **(OK)** + **(Up/Down)** → **ENGLISH** → **(OK)**

3 - Installation configuration

▶ INSTALLATION TYPE → **(OK)** + **(Up/Down)** → **1 RADIATOR ZONE** → **(OK)**

INSTALLERS

Settings

Your installation consists of a single radiator zone or direct floor system 2/3

4 - Radio accessories

Warning : This menu must only be used when installing one or more of these accessories > please refer to the section on "Activating the accessories".

▶ RADIO SATELLITE → **OK** → ▶ IN OUTDOOR SENSOR REPEATER THERMOSTAT 2 MODEM OFF OFF OFF OFF

5 - Heating control

▶ HEATING CONTROL → **OK** → ▶ HEATING SETPOINT → **OK** → **AUTO** **MANUAL**

Selecting **AUTO** is recommended so that you can benefit from automatic circuit temperature control.

However, if you wish to adjust the radiator temperature yourself, select **MANUAL**. Then return to the user menu to set the radiator temperature.

a/ Press **MENU** for 5 seconds

b/ **▲** → ▶ SET RADIATOR T_i → **OK** + **▲** → ▶ SET RADIATOR T_i **50°C** **OK TO VALIDATE**

6 - Boiler configuration

▶ BOILER CONFIG. → **OK** → ▶ MAX OUTPUT CHIMNEY SET MAX RADIATOR T_i MIN RADIATOR T_i PUMP MODE → **▲** **▼**

6.1 Limiting the maximum heating power

▶ MAX OUTPUT → **OK** → **16kW** **15kW** **14kW** → **▲** **▼** → **OK**

Your installation consists of a single radiator zone or direct floor system 3/3

6.2 Adapting the length of the vent

▶ CHIMNEY SET → No setting is required for this type of boiler. Codes displayed do not affect functioning of the boiler.

6.3 Selecting the maximum radiator temperature

▶ MAX RADIATOR T_i → **OK** → **MAX 73°C** **MAX 65°C** **MAX 50°C** → **▲** **▼** → **OK**

Warning : for direct floor systems, do not exceed a temperature of 50°C.

6.4 Selecting the minimum radiator temperature

▶ MIN RADIATOR T_i → **OK** → **MIN 50°C** **MIN 38°C** **MIN 28°C** **MIN 22°C** → **▲** **▼** → **OK**

6.5 Selecting the pump's operation

▶ PUMP MODE → **OK** → **WITH BURNER** **WITH THERMOSTAT** **PERMANENT** → **▲** **▼** → **OK**

Operation **WITH THERMOSTAT** is recommended in all cases except for direct floor heating, in which case you should select: **PERMANENT**

6.6 Choice of preheat

▶ PREHEAT → **OK** → **OFF** **AUTO** **ON**

In ON mode, the boiler holds the exchanger at the required temperature between 5 O'clock a.m. and 11 O'clock p.m. in order to warrant optimal reactivity for the supply of sanitary hot water.

In AUTO mode, the boiler memorizes the day to day requirements of the family, and triggers the pre-heating a few minutes before the first use of sanitary hot water of the day.

In OFF mode, the function is inhibited.

WHEN YOU HAVE COMPLETED PARAMETERS, press **MENU** for approx. 5 seconds to return to the initial display.

Accessories settings

1/3

Progress of the operations : Please note that pressing button **C** at any time takes you back to the previous step.

1 - Access to the Radio accessories menu

• Connect connector (A) on the room thermostat as described page 44.

• Press **MENU** for 5 seconds to call up the following menu:

- ▶ INSTALLER MENU
- AFTERSALES MENU
- FAULT HISTORY
- BOILER DATA

• Select the installer menu:

▶ INSTALLER MENU → **OK** + **▲** → ▶ ACCESS CODE
96 → **OK** + **▲** → ▶ RADIO ACCESSORIES
 HEATING REGULATION
 BOILER CONFIG.

• Select the Radio accessories menu:

▶ RADIO ACCESSORIES → **OK** → ▶ EXT. SENSOR OFF
 REPEATER OFF
 THERMOSTAT 2 OFF
 MODEM OFF

2 - External sensor

2.1 External sensor recognition

▶ EXT. SENSOR OFF → **OK** → ▶ CONNECT → **OK**

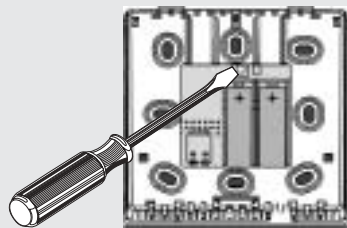

Hold the satellite button, situated on the backside of the external sensor box, depressed for 10 seconds. To establish connection, the sensor transmits signals – this may require several minutes – until it is acknowledged by the room thermostat which then validates the connection through the following display :

▶ EXT. SENSOR ON
 REPEATER OFF
 THERMOSTAT 2 OFF
 MODEM OFF

The external sensor is now operating

Accessories settings

2/3

2.2 Heating setpoint

• Reach into the Heating Set Point menu to select the desired regulating mode.

▶ EXT. SENSOR ON → **C** + **▲** → ▶ HEATING REGULATION → **OK** →
 BOILER CONFIG.
 CHOOSE LANGUAGE

a/ Heating setpoint

▶ HEATING SETPOINT → **OK** → **AUTO**
 T_i HEATING OFF **MANUAL**

The **AUTO** setting is recommended to obtain automatic regulation of circuit temperatures. In such case, no slope adjustment is required. The boiler will itself select, after a few days, the slope which is the most suited to the heating installation.

b/ T° heating off

▶ T_i HEATING OFF → **OK** → **0°C ... 16°C 17°C 18°C ... 40°C** → **OK**
 HEATING SETPOINT

Note : we recommend selecting 17 or 18°C.

You may retain the advantages conferred by the external sensor, while setting yourself the slopes of the sensor. Select the **MANUAL** setting and adapt the following parameters :

▶ SLOPE ZONE 1 → **OK** → **0,2 ... 0,6 0,8 0,7 ... 4,0** → **OK**
 SLOPE ZONE 2 → **OK** → **0,2 ... 1,4 1,5 1,6 ... 4,0** → **OK**
 CORRECT T_i ZONE1 → **OK** → **-5°C ... -1°C 0°C 1°C ... 5°C** → **OK**
 CORRECT T_i ZONE2 → **OK** → **-5°C ... -1°C 0°C 1°C ... 5°C** → **OK**

Select the code following curves given on diagram below.

NB: Zone 2 settings are only displayed when two heating zones have been selected in the "config. Installation" menu.

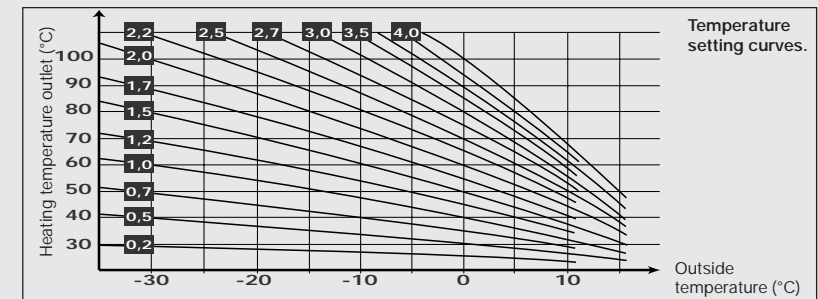

Accessories settings
3/3

3 - Repeater

▶ REPEATER OFF → **OK** → ▶ CONNECT

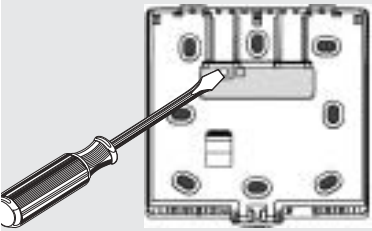

Hold the satellite button situated on the back side of the radio relay box depressed for 10 s.

To establish the connection, the radio relay transmits signals until it is recognized by the room thermostat which validate the connection by the following display :

▶ REPEATER	ON
THERMOSTAT 2	OFF
MODEM	OFF
EXT. SENSOR	OFF

The repeater is now operating

4 - Room thermostat 2

▶ THERMOSTAT2 OFF → **OK** → ▶ CONNECT



Disconnect the cable of the zone 1 room thermostat, and connect it to thermostat 2. This is sufficient to have it recognized by the boiler.

Take the cable and reconnect it to zone 1 room thermostat and press the **C** key. The following display will confirm the connection:

▶ THERMOSTAT 2	ON
MODEM	OFF
EXT. SENSOR	OFF
REPEATER	OFF

The room thermostat 2 is now operating

Glossary for the installer menu

Select the language	Selecting the language on the thermostat's display.
Installation config.	Selecting the type of heating installation.
Clock zone 2	The ON position of this menu assigns the TA1 clock function to the radiator zone. In such case, the ambient temperature at floor level is selected from the TA1 user's menu.
Radio accessories	Activating the various radio accessories on the installation.
Heating regulation	Selecting Automatic or Manual control mode. In Automatic mode, the radiator temperature adapts automatically to the heating requirements of the room in which the thermostat is located, operating between the maximum and minimum temperature values set.
Boiler config.	Selecting the boiler's main operating parameters (power and heating circuit temperatures, pump mode and airflow configuration).

INSTALLERS

Gas conversion

Your **Isofast** boiler is factory-set to operate with **G20 gas**.

For operation with G31 gas, some adjustments must be made on the gas valve after removal of the sealed front cover in order to obtain the CO₂ values given in the adjacent table.

1/ Maximum hot water input setting, through the CO₂.

a - Connect a CO₂ analyser to sample point **B** of the adapter or flue elbow.

b - Fully open a hot water tap.

c - Wait for 2 minutes or so, until the CO₂ reading has stabilized.

d - Adjust the screw **C** to obtain the G31 CO₂ value stated in the table, taking the following principle into account:

To increase the CO₂ value, turn the screw anti-clockwise
To decrease the CO₂ value, turn the screw clockwise

Note : After re-installation of the sealed front face, the CO₂ value changes, and must correspond to that given in the table.

Isofast F 35 E		G20	G31
Heating output max. hot water	kW	34,2	34,2
Heating output max. heating	kW	6,4	6,4
CO ₂ case off	%	9±0,2	10,3±0,2
CO ₂ case on	%	9,2±0,3	10,5±0,3

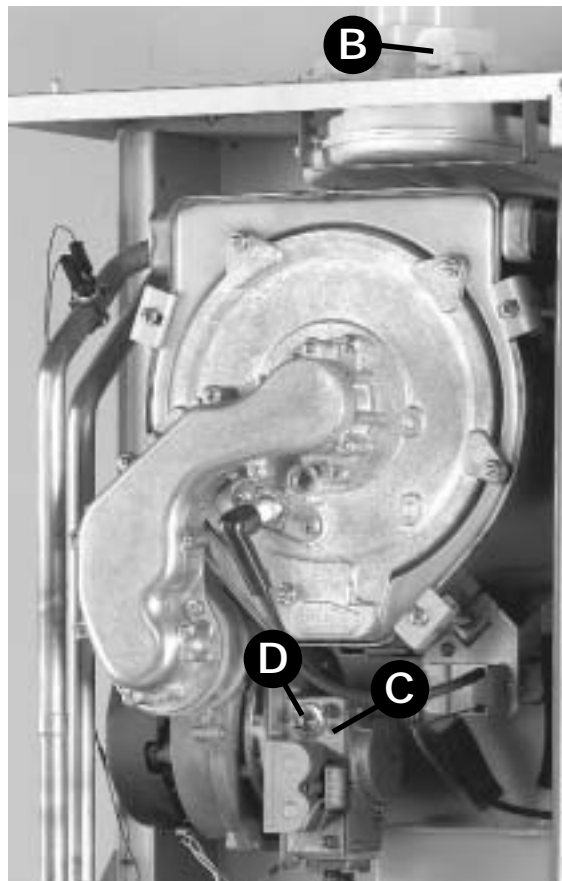

2/ Minimum HEATING input setting, through the CO₂ :

a - Connect a CO₂ analyser to sample point **B** of the adapter or flue elbow.

b - Adjust the boiler at its minimum heating power using the room thermostat menus described in the below.

c - Perform a heating demand and record the

CO₂ value after stabilization (2 minutes or so).

d - Adjust the screw **D** to obtain the G31 CO₂ value stated in the table, taking the following principle into account :

To increase the CO₂ value, turn the screw clockwise
To decrease the CO₂ value, turn the screw anti-clockwise

Note : After re-installation of the sealed front face, the CO₂ value changes, and must correspond to that given in the table.

3/ After setting and reassembly, restore the maximum heating power to its initial value (20 kW) and stick the gas data tag close to the nameplate.

1 - Access to the installer menu

• Connect **A** connector on the room thermostat as indicated page 44.

• Press **MENU** for 5 seconds to call up the following menu: ▶ **INSTALLER MENU**
 AFTERSALES MENU
 FAULT HISTORY
 BOILER DATA

• Select the Installer menu:

▶ **INSTALLER MENU** → **OK** + **▲** → ▶ **ACCESS CODE**
96 → **OK** → ▶ **CHOOSE LANGUAGE**
 INSTALLATION TYPE
 RADIO SATELLITE
 HEATING REGULATION
 BOILER CONFIG.

2 - Access to boiler configuration

▶ **BOILER CONFIG.** → **OK** → ▶ **MAX OUTPUT** → **OK**
 CHIMNEY SET
 MAX. RADIATOR T_i

• Set **MAX OUTPUT** on the minimal value:

▶ **MAX OUTPUT** → **OK** + **▲** → **6 kW**
5 kW → **OK**

WHEN YOU HAVE COMPLETED PARAMETERING, press **MENU** for approx. 5 seconds to return to the initial display.

INSTALLERS

Servicing

Important Notes

To ensure the continued efficient and safe operation of the boiler it is recommended that it is checked and serviced at regular intervals. The frequency of servicing will depend upon the particular installation and usage, but in general once a year should be enough.

It is the Law that any servicing is carried out by a competent person. When replacing a part on this appliance, use only spare parts that you can be assured conform to the safety and performance specification that we require. Do not use reconditioned or copy parts that have not been clearly authorised by Saunier Duval.

General

Measurement of the products of combustion can be achieved by connection of a probe to the combustion analyser test point, see **diagram 1**.

IMPORTANT NOTE :

Products of combustion will be discharged when the cap is removed. It is important to replace the cap immediately. Before commencing with a service or replacement of parts, the boiler should be

isolated from the electrical supply and the gas supply should be turned off at the gas isolation valve, see **page 35**.

All routine servicing requirements can be achieved by the removal of the front panel and inner panel only. To remove simply undo the two screws on the underside of the front panel and lift off. Undo the two screws on the front of inner panel and lift off, see **diag. 2**. Unless stated otherwise any part removed during servicing should be replaced in the reverse order to removal.

Service should always include the removal of any debris from the condensate pipe and siphon. After completing any servicing of gas carrying components, ALWAYS test for gas soundness and carry out a functional test of the controls.

Spark Electrode

Disconnect the electrode lead and two securing screws. Withdraw the spark electrode carefully from the combustion chamber, see **diagram 3**. Inspect the tips for damage. Clean away any debris and check the spark gap is 3.5 to 4.5 mm.

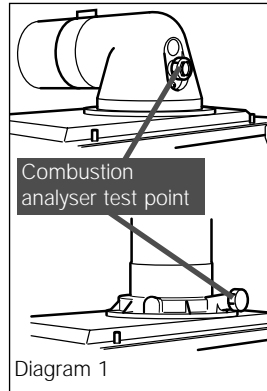

Diagram 1

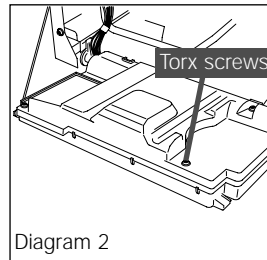

Diagram 2

Check the electrode gasket for signs of damage and replace if necessary.

Burner

Drop down the control panel into the service position. Disconnect the gas supply at the gas service cock. Remove the two gas pipe retaining clips, one located below gas valve and the other one located on the underside of the boiler chassis.

Pull sealing grommet down gas pipe **diagram. 4**.

Push the gas pipe upwards further into gas valve connection and then rotate anti-clockwise (looking down) until the gas pipe end is over the large hole in boiler chassis. Withdraw the gas pipe from gas valve connection and remove. Note : When replacing ensure that the sealing grommet, situated below the gas valve is correctly re-seated.

Disconnect the gas valve electrical plug at the gas valve.

Disconnect the electrical leads from the fan. Remove the five combustion chamber front retaining nuts, see **diag. 5**. Gently remove the fan, gas valve and burner assembly from the combustion chamber, see **diag. 5**. Clean the burner with a soft brush taking great care not to damage the front insulation. DO NOT use

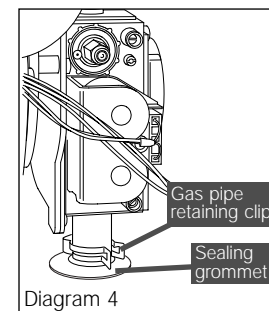

Diagram 4

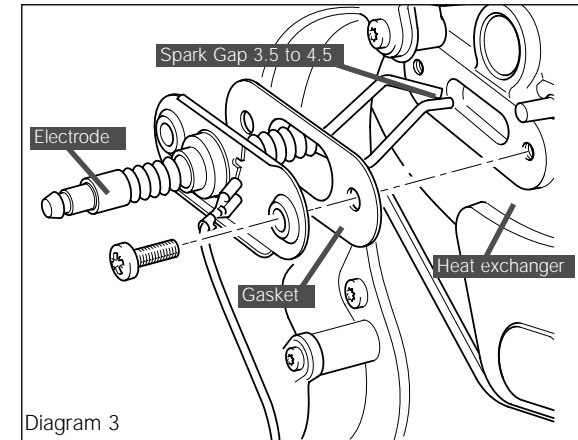

Diagram 3

wire or sharp instruments to clean the holes of the burner. Inspect the burner for any signs of damage. Inspect the sealing rings and replace if necessary.

Removal of the burner is not necessary during a normal service. NOTE : IF THE BURNER HAS TO BE REMOVED IT WILL REQUIRE A NEW GASKET WHEN REFITTED.

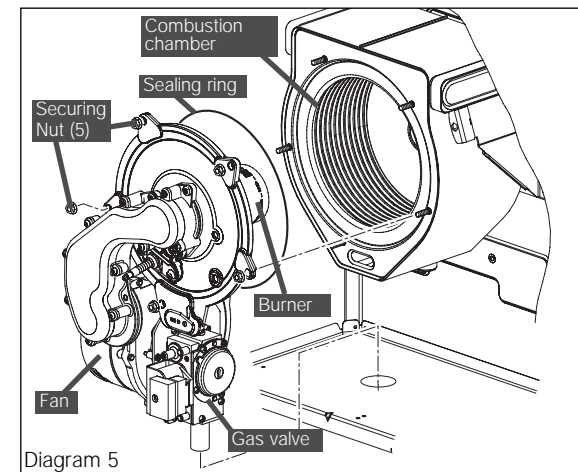

Diagram 5

INSTALLERS

Servicing

Combustion Chamber and Heat Exchanger

Remove loose debris from combustion chamber using a soft brush and vacuum cleaner. Carefully flush by spraying water removing any remaining debris through the condensate trap (Ensure the water is kept away from electrical components).

Condensate Drain

The condensate drain does not normally need removing during servicing. To flush the condensate drain carefully pour water into the heat exchanger and check that water flows freely to drain.

Combustion Check.

If a gas carrying component has been replaced, the combustion of the appliance should be checked. Once the appliance has been re-assembled (apart from the front and inner casing panels) connect a CO2 combustion analyser to the test point on the flue adapter, and follow indications given on [page 52-53](#).

Domestic Cold Water Inlet Filter

If the water flow rate through the appliance has reduced it may be necessary to clean or



Diagramm 6

replace the water inlet filter. Turn off the electrical supply to the boiler.

Drain the domestic hot water circuit. Slide out the securing clip, and remove the filter to clean or renew if necessary, [see diag. 6](#).

Replace the filter into its housing and replace the securing clip.

Open the cold water isolating valve and test the Domestic Hot Water circuit for soundness. Check for leaks.

"Mouss" Filter

Turn off the electrical supply to the boiler.

Drain the heating circuit of the boiler.

Remove the filter retaining clip under the pump [see diag. 7](#), and filter clean or renew if necessary. Refit the filter.

Open the heating flow and return isolating valves and refill, vent and pressurise the heating circuit.

Check for leaks.



Diagramm 7

Central Heating Return Filter

Turn off the electrical supply to the boiler.

Drain the heating circuit of the boiler.

Unscrew the filter placed on heating return, [see diag. 8](#), and clean filter or renew if necessary. Refit the filter.

Open the heating flow and return isolating taps and refill, vent and pressurise the heating circuit.

Check for leaks.

Draining of Boiler Heating Circuit

Drain down the Heating Circuit of the boiler only, by closing the heating flow and return isolating taps (**t**, **u** and **w**), on the boiler connections, [see diag. 10](#). Attach a length of hose to the drain point and open the drain valve (**r**), [see diag. 9](#). After servicing or replacing parts, close the drain valve and remove the hose. Open the heating flow and return isolating valves and refill, vent and pressurise the heating circuit. Check for leaks.

Draining of Boiler Hot Water Circuit

Drain the Domestic Hot Water circuit by closing the cold-water isolation tap (**v**) on the boiler connection. Open one or more hot water taps to drain the hot water circuit.

After servicing or replacing parts open the cold-water isolation valve and slowly open a hot water tap to



Diagramm 8

remove air. Close the hot water tap and check for any leaks.

Inner Casing Panel Seal Check.

Check the condition of the seal, replace as required. To replace remove the old seal, thoroughly clean the casing surfaces. Fit the new seal, it is supplied to the correct length.



Diagramm 9



Diagramm 10

INSTALLERS

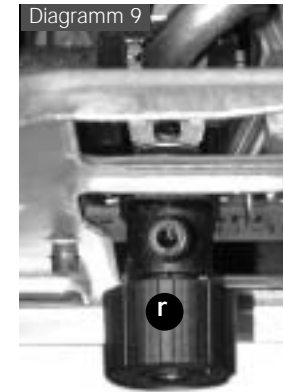
Servicing

The use of the menus described here after is exclusively reserved for the after-sales personnel.

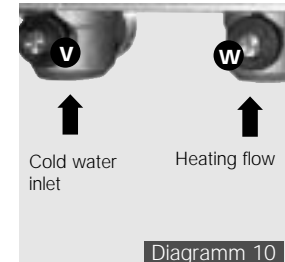
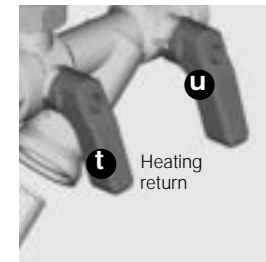
The after-sales menus, accessible from the room thermostat, allow investigating possible malfunctions and modifying certain factory set values.

Access to the data menu

• Connect boiler connector (A) on the room thermostat as described page 44.

• Press **MENU** for 5 seconds to call up the following menu:

▶ INSTALLER MENU
AFTERSALES MENU
FAULT HISTORY
BOILER DATA

1 - "Fault history" menu

• Use the  buttons to select the "Fault history" menu:

▶ FAULT HISTORY
BOILER DATA
INSTALLER MENU

→ **OK** →

▶ FAULT HISTORY
TUE 04/02/03 10
--/--/--

The display shows the fault N° and its date of occurrence.

2 - "Boiler data" menu

• Use the  buttons to select the "Boiler data" menu

▶ BOILER DATA
INSTALLER MENU
AFTERSALES MENU
FAULT HISTORY

→ **OK** →

▶ WATER PRESSURE
RADIATOR SETPOINT
FLOW T_i
RETURN T_i
DHW T_i
TANK T_i
FAN SPEED
DHW FLOW
BURNER PHASE
POWER

→  + **OK**

Every validation through the OK key will cause display of the corresponding value during boiler operation.

WHEN YOU HAVE COMPLETED PARAMETERS, press **MENU** for approx. 5 seconds to return to the initial display.

Accessing the Aftersales menu

• Connect boiler connector (A) to the room thermostat as described page 44 :

• Press **MENU** for 5 seconds to call up the following menu:

▶ INSTALLER MENU
AFTERSALES MENU
FAULT HISTORY
BOILER DATA

• Select Aftersales menu

▶ AFTERSALES MENU
FAULT HISTORY
BOILER DATA

→ **OK** +  →

▶ ACCESS CODE
XX

→ **OK** →

▶ BOILER CODE
MIN. FAN SPEED
MAX. FAN SPEED
START FAN SPEED
BURNER OVERRIDE
FAULT RESET
AFTERSALES TEL

▶ BOILER CODE → **OK** +  → Attention: The code is pre-recorded at the factory. Note: The code corresponding to the boiler is indicated on the nameplate.

▶ MIN. FAN SPEED → **OK** +  → This factory-set value corresponds to the minimum input.

▶ MAX. FAN SPEED → **OK** +  → This factory-set value corresponds to the maximum input.

▶ START FAN SPEED → **OK** +  → Fan start-up speed selection

▶ BURNER OVERRIDE → **OK** +  → Allows analysing boiler operation at its minimum or maximum power.

▶ FAULT RESET → **OK** → Erases the fault log.

▶ AFTERSALES TEL → **OK** +  → Recording of after sales service telephone No. This No. will be displayed on thermostat screen in case of malfunction requiring attendance by a professional.

WHEN YOU HAVE COMPLETED PARAMETERS, press **MENU** for approx. 5 seconds to return to the initial display.

Communication test

• DO NOT connect the boiler connector to the room thermostat.

• Press **MENU** for 5 seconds to call up the following menu : ▶ TEST RADIO SIGNAL

The room thermostat then transmits signals every 10 s. Successive display of the numbers 1, 2, 3, 4 means that the signals are properly routed.

INSTALLERS

Wiring diagram

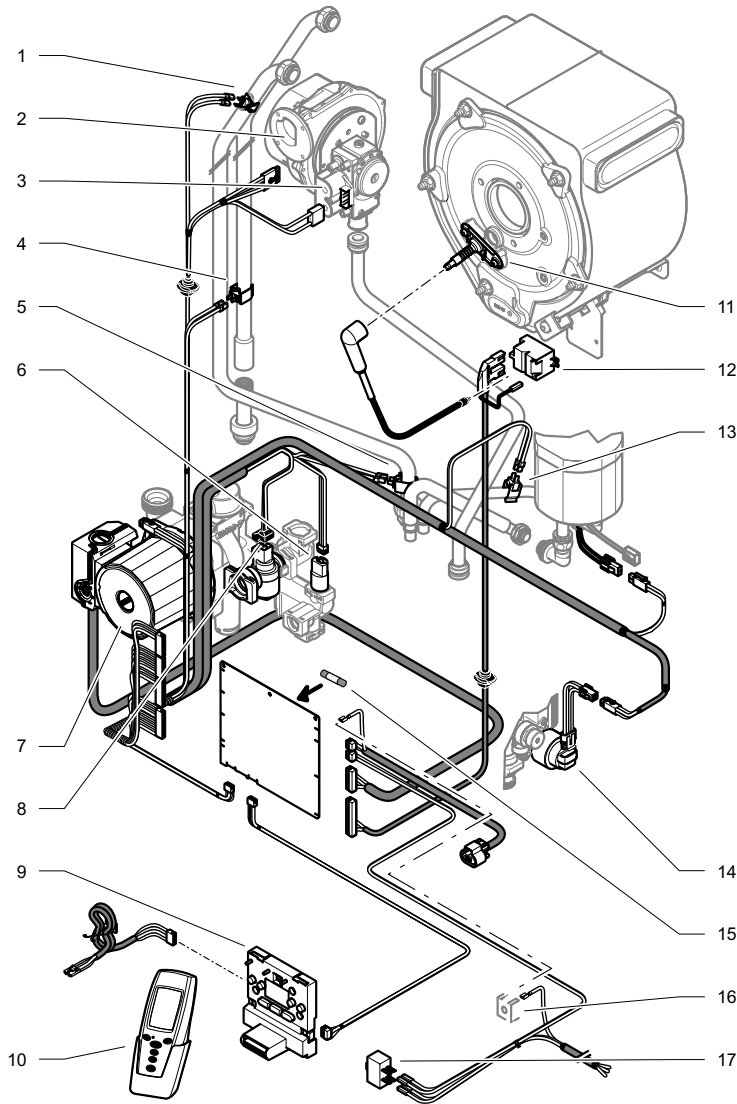

Wiring diagram

- | | | |
|-------------------------------|-------------------------------------|------------------------|
| 1 - Overheat thermostat | 9 - User interface | 16 - Chassis earth |
| 2 - Fan | 10 - Room thermostat | 17 - Main reset switch |
| 3 - Gas valve | 11 - Ignition and control electrode | |
| 4 - Heating return thermistor | 12 - Ignition module | |
| 5 - Heating flow thermistor | 13 - DHW temperature sensor | |
| 6 - Water pressure sensor | 14 - Three way valve | |
| 7 - Pump | 15 - Fuse 630 mA | |
| 8 - Water flow sensor | | |

Fault finding

NOTE

Before trying to operate the boiler make sure that :

- All gas supply cocks are open and that the gas supply has been purged of air.
- There is a permanent mains supply to the boiler.
- There is a heating demand from the external control.

WARNING.

Always isolate the boiler from the electrical supply before carrying out any electrical replacement work.

Always check for gas soundness after any service work.

Electrical Testing

Should there be any doubt about the voltage supply to any of the components, it is possible to carry out a simple electrical test.

Important. On completion of the Service/Fault Finding tasks which have required the breaking and remaking of the electrical connections the earth continuity, polarity,

short circuit and resistance to earth checks must be repeated using a suitable multimeter.

To carry out the electrical test, gain access, as follows : Hinge down the control box and remove Torx screws and unhook the rear panel, refer **diagram 2 page 54**. Refer to the Wiring diagram and fault finding charts diagrams.

INSTALLERS

Fault finding

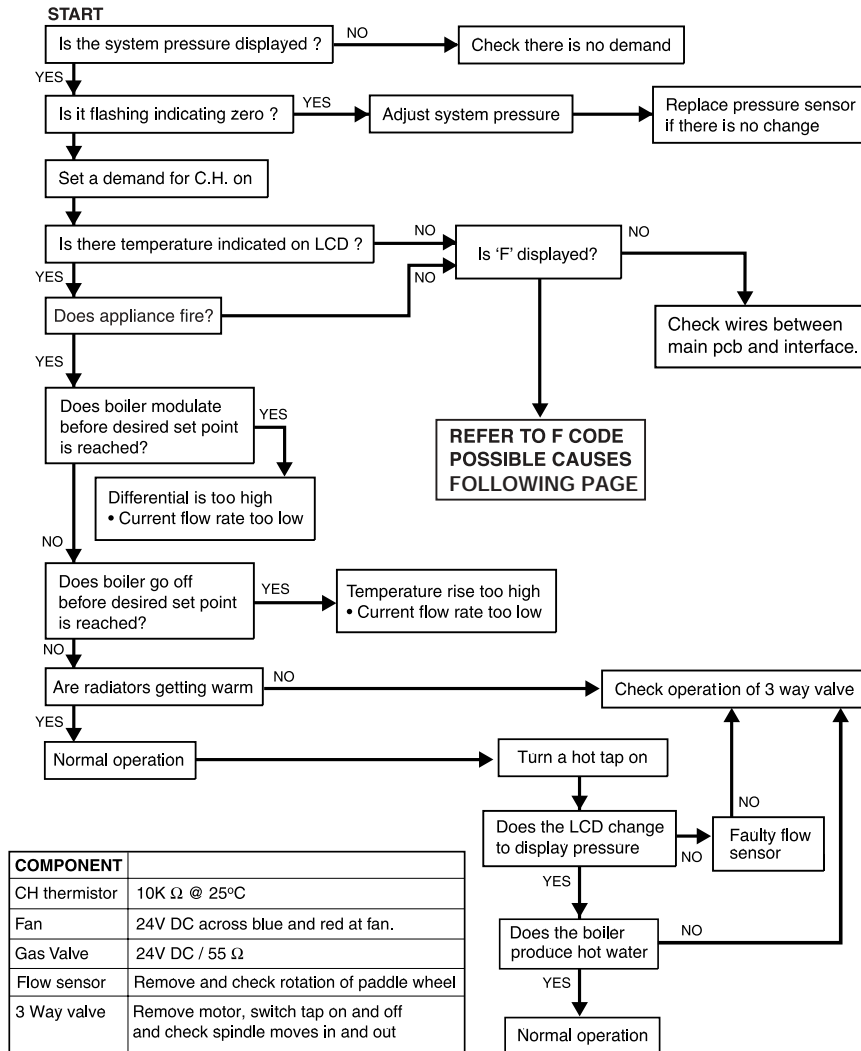

CODE	DESCRIPTION	POSSIBLE CAUSE
F1	Ignition fault (lockout) Boiler failed to light	No gas Insufficient gas Incorrect gas valve adjustment Electrode Ignition lead defect Electronic igniter defective Check air inlet duct Check connections to igniter unit
F4	Ignition fault (lockout) Went out when lit	As F1 possible cause
F5	Overheat fault	Overheat stat operated Maximum temperature exceeded Check thermistor connections Air in system with thermistor at maximum setting Faulty overheat stat connection
F6	Central heating flow thermistor fault	Thermistor cable defective/broken, thermistor faulty Check that thermistor attached correctly to pipe
F7	Domestic Hot Water thermistor fault	Thermistor cable defective/broken, thermistor faulty Check that thermistor attached correctly to pipe
F9	Water pressure sensor fault	Faulty sensor connection Check wiring
F10	Central heating return thermistor fault	Thermistor cable defective/broken, thermistor faulty Check that thermistor attached correctly to pipe
F11	Main board connection fault	Check wiring between mainboard and user interface
F12	User interface connection fault	Check wiring between mainboard and user interface
F13	Main PCB connection fault	Check connections and wires
F14	Central heating flow temperature is greater than 95°C	System fault Possible pump failure Check Thermistor on flow
F16	Flame detection fault (flame presence for more than 5 seconds after burner stopped)	Gas valve defective
F17	Power supply is less than 170V	Check electrical supply / polarity
F18	User interface fault	Faulty User Interface
F19	Central heating thermistor unplugged	Check Thermistor connection
F20	Software incompatibility	Incorrect user interface or Main PCB
F24	Central heating return temperature is greater than 90°C	System fault Possible pump failure Check Thermistor on return
F25	Maximum temperature rise slope	Possible pump failure Air in system
F26	Maximum delta temperature	Check Thermistor on return System - too restrictive

INSTALLERS

Replacement of parts

General

Replacement of parts must be carried out by a competent person. Before replacing any parts the boiler should be isolated from the mains electric supply and the gas should be turned off at the service cock on the boiler. Unless stated otherwise parts are replaced in the reverse order to removal. After replacing any parts always test for gas soundness and if necessary carry out functional test of the controls. For replacement of parts the front casing and the inner casing panel of the boiler will need to be removed. To remove undo the two screws on the underside of the front casing and lift off. Undo the two screws on the front of the inner front panel and lift off. The side panels can be hinged sideways to aid replacement of parts. To hinge a side panel undo and remove the three screws securing each side panel to the boiler, two at the front and one at the top.

Spark Electrode
For access, refer to section "General". Remove the spark plug lead, earth lead and two

securing screws. Withdraw the spark electrode carefully from the combustion chamber, see **diagram 3** page 55.

Igniter Unit

For access, refer to section "General". Remove ignition lead and electrical connections then remove igniter unit by removing two securing screws, see **diagram 1**.

Ignition Lead

For access, refer to section "General". Pull the spark plug style connector off the spark electrode and the spade connector connected to the igniter unit, see **diagram 1**.

Gas Valve

For access, refer to section "General". Remove the electrical plug from the gas valve, see **diagram 2**. Refer to **pages 54 and 55** for removal of the fan, gas valve and burner assembly. Before removing the gas valve note its position on the fan. Remove the three securing screws, which fix the gas valve and plastic swirl plate to the venturi on the fan, see **diagram 3**. Remove the gas valve.

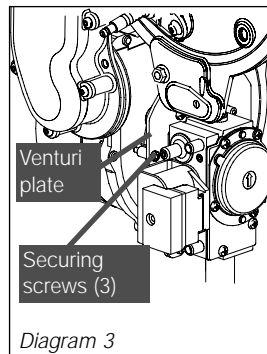
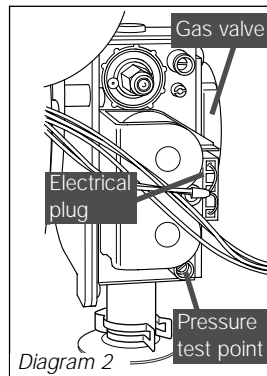
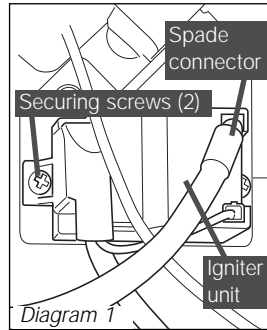

When re-fitting the gas valve take care as it can be fitted more than one way. After re-fitting check the combustion CO2 and adjust if necessary, see page **52-53**. After assembly test for gas soundness and purge in accordance with the current issue of BS6891 or in IE, the current edition of I.S.813 "Domestic Gas Installations".

Fan

For access, refer to section "General". Refer to **pages 54 and 55** for removal of the fan, gas valve and burner assembly. Remove the gas valve. Remove the venturi plate secured with three screws, see **diagram 3**. Remove the two screws securing the fan to the gas manifold, see **diagram 4**, check the gasket and replace if necessary.

Burner

For access, refer to section "General". Refer to **pages 54 and 55** for removal of the fan, gas valve and burner assembly. Remove the four screws that secure the burner, see **diagram 5**. NOTE : THE BURNER WILL REQUIRE A NEW GASKET WHEN REFITTED.

Front Insulation

For access, refer to section "General". Refer to **pages 56 and 57** for removal of the fan, gas valve and burner assembly. Remove burner as previous section. Remove spark electrode.. NOTE: THE BURNER WILL REQUIRE A NEW GASKET WHEN REFITTED.

Rear Insulation

For access, refer to section "General". Refer to **pages 54 and 55** for removal of the fan, gas valve and burner assembly. Remove securing screw and washer in the centre of the insulation and withdraw insulation, see **diagram 6**.

Viewing Window

For access, refer to section "General". Refer to **diagram 7**. Remove circlip. Remove steel washer. Remove glass. Remove fibre washer. Replace in reverse order.

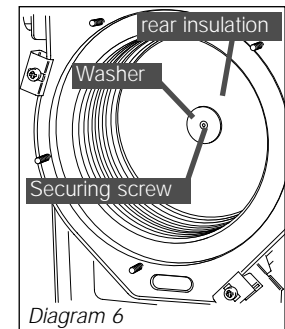
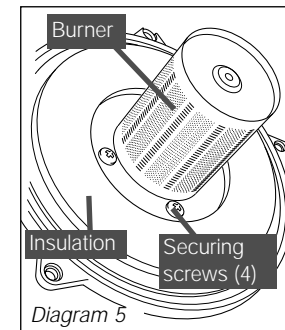
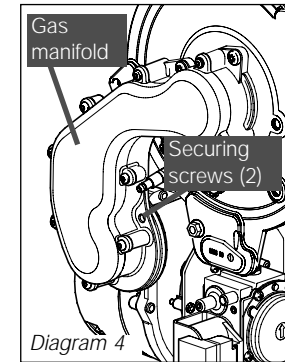
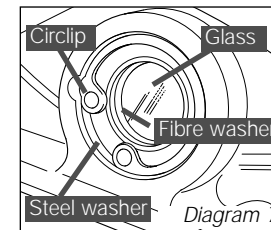

INSTALLERS

Replacement of parts

Expansion Vessel

For access, refer to section "General".
Refer to **page 57** and drain the boiler heating circuit.
Undo the coupling at the base of the vessel, see **diagram 8**.
While holding the vessel remove the securing bolt on the top panel of the boiler.
Remove upper support bracket.
Lift the vessel up, draw bottom out to the left, lower and remove.
Fit the replacement unit.
Fit a new gasket between the expansion vessel and coupling.
Refill, vent and pressurise the boiler.
Check for leaks.

Heat Exchanger

For access, refer to section "General".
Refer to **pages 54 and 55** for removal of the fan, gas valve and burner assembly.
Drain the boiler heating circuit, and the hot water circuit see **page 57**.
Remove the clip securing the clear condense pipe to heat exchanger.
Pull to remove the clear condense pipe out of the bottom of the heat exchanger.
Undo the two nuts of the flow and return pipes from

the heat exchanger.
Move the pipes away from the heat exchanger.
Loosen the three heat exchanger securing screws and clamps (two at the top and one at the bottom) to remove the heat exchanger, see **diagram 9**.
CAUTION: There will be water in the heat exchanger.
Remove condense pipe connector from bottom of heat exchanger.
Carefully ease heat exchanger out.

Flue Hood

For access, refer to section "General".
Remove heat exchanger as per previous section.
Remove the two securing screws and pull the flue hood down and away from the flue elbow, see **diagram 10**.

Diverter Valve Motor

For access, refer to section "General".
Refer to **diagram 11**.
Remove the electrical plug.
Unscrew the retaining nut.
Remove the diverter valve motor.

Pump (head only)

For access, refer to section "General".
Drain the boiler heating circuit.



Diagram 8

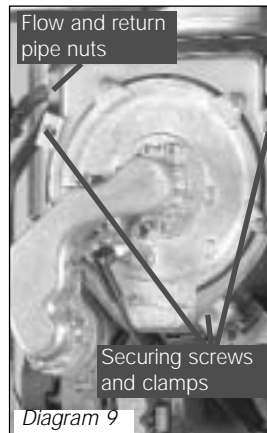

Diagram 9

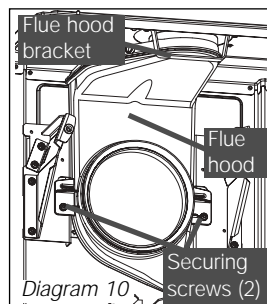

Diagram 10

Refer to **diagram 12**.
Remove the four cap head screws.
Carefully remove the pump head together with cable.
Do not strain cable.
Support the pump head, unscrew cable cover at the side of pump head and take off.
Disconnect wiring from pump head.
Reconnect wiring to new pump head and fit cover.
Fit the new pump head with 'O' ring.
Refill, vent and pressurise the boiler.
Check for leaks.

Safety Discharge Valve

For access, refer to section "General".
Drain the boiler heating circuit.
Refer to **diagram 13**.
Undo the safety discharge valve union and remove from the pipework.
Remove the securing clip and withdraw the safety discharge valve.
Fit new 'O' ring.
Refill, vent and pressurise the boiler.
Check for leaks.

Domestic Hot Water Thermistor

For access, refer to section "General".
Drain the boiler domestic

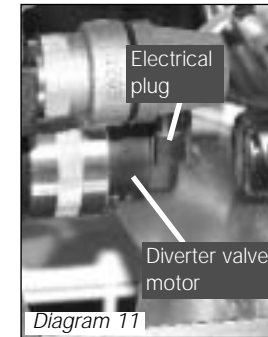

Diagram 11

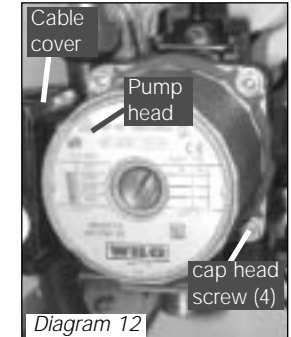

Diagram 12

hot water circuit.
Refer to **diagram 14**.
Disconnect the domestic hot water thermistor electrical connections.
Remove retaining clip.
Withdraw domestic hot water thermistor from its housing.
Note : When reconnecting electrical connections, polarity is not important.
Fit new 'O' ring.
Carry out a functional test of the controls.

Heating Flow Thermistor

For access, refer to section "General".
Refer to **diagram 15**.
Remove the electrical connections from the thermistor.
Remove the retaining clip from the flow pipe.
Note: When reconnecting the polarity of the wiring to thermistors is unimportant.

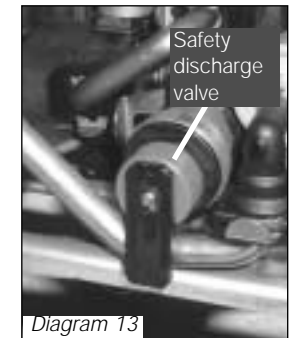

Diagram 13

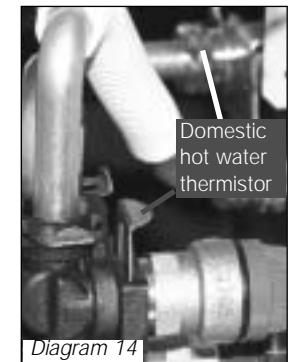

Diagram 14

INSTALLERS

Replacement of parts

Heating Return Thermistor

For access, refer to section "General".

Refer to diagram 15.

Remove the electrical connections from the thermistor.

Remove the retaining clip from the flow pipe.

Note: When reconnecting the polarity of the wiring to thermistors is unimportant.

Overheat Thermostat

For access, refer to section "General".

Refer to diagram 15.

Remove the electrical connections from the overheat thermostat.

Remove the retaining clip from the flow pipe.

Remove the overheat thermostat from the retaining clip.

NOTE. When fitting new thermostat, please ensure that it is located correctly onto the flat area of the pipe and the retaining clip is secure.

Automatic Air Vent

For access, refer to section "General".

Drain the boiler heating circuit.

Refer to diagram 16.

Remove the retaining clip and remove the automatic air vent.

Fit the new automatic air

vent and 'O' ring ensuring the vent cap is left loose.

Refill, vent and pressurise the boiler.

Check for leaks.

Flow Sensor

For access, refer to section "General".

Drain down the hot water circuit.

- Undo the union nut on the cold water inlet isolating valve.

- Pull out slotted metal clip securing filling system tap into housing, swing the tap forwards.

- Pull out the two slotted metal clips retaining the domestic water inlet filter housing.

- Remove domestic water inlet filter housing.

- Remove electrical connections from water flow sensor.

- Pull off slotted metal clip and remove water flow sensor.

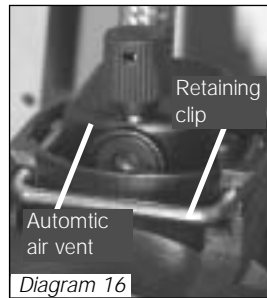
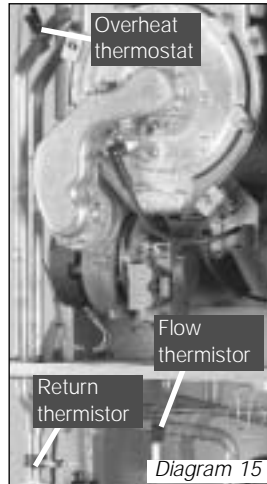
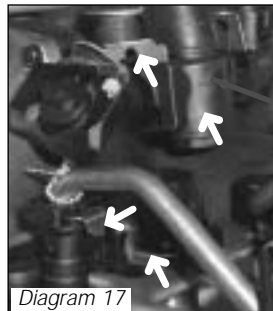

Low Water Pressure Sensor

For access, refer to section "General".

Drain the boiler heating circuit.

Refer to diagram 18.

Disconnect the electrical lead by pushing up retaining tab to withdraw the lead plug.

Remove the retaining clip to remove the low water pressure sensor.

Fit new 'O' ring.

Fit the new low water pressure sensor. Refill and pressurise the boiler.

Check for leaks.

Bypass Valve

For access, refer to section "General".

Drain the boiler heating circuit.

Refer to diagram 19.

Remove the retaining clip to remove the bypass valve.

Fit new 'O' rings.

Replace the bypass valve, refill, vent and pressurise the boiler.

Adjust the bypass as described pages 22-23.

Check for leaks.

Filling Loop Tube

For access, refer to section "General".

Drain the boiler hot water circuit.

Refer to diagram 20.

Remove the retaining clips to remove the filling loop tube.

Fit new 'O' rings.

After replacing the filling loop tube open the cold-water isolation valve and slowly open a hot water tap to remove air. Close the hot water tap and check for any leaks.

Filling Loop Valve

For access, refer to section "General".

Drain the boiler hot water circuit.

Refer to diagram 20.

Remove the clip securing the filling loop valve to the domestic water filter housing.

Disengage by pulling forward.

Remove the clip securing the filling loop to the filling loop valve.

Remove the filling loop valve from the filling loop.

Fit new 'O' rings.

After replacing the filling

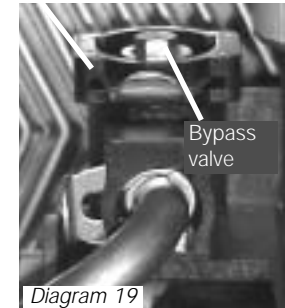
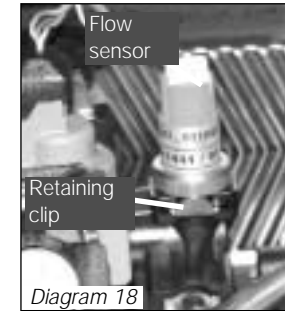

loop valve open the cold water isolation valve and slowly open a hot water tap to remove air. Close the hot water tap and check for any leaks.

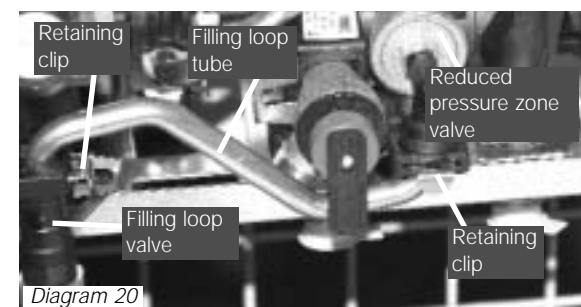

INSTALLERS

Replacement of parts

Reduced Pressure Zone Valve

For access, refer to section "General".
Refer to diagram 20.
Drain the boiler hot water circuit.
Remove the filling loop
Remove the retaining clip to remove the reduced pressure zone valve.
Fit new 'O' rings.
Replace the reduced pressure zone valve, refill, vent and pressurise the boiler.
Check for leaks.

Domestic Cold Water Inlet Filter

For access, refer to section "General".
Refer to page 56.
Fit new 'O' rings.

Central Heating Filter

Refer to section page 56.
Fit new 'O' rings.

Heating Circuit Drain Point

Refer to page 57 to drain the boiler heating circuit.
Refer to diagram 21.
Remove the retaining clip to remove the drain point.
Fit new 'O' rings.
Replace the drain point, refill, vent and pressurise the boiler.
Check for leaks.

Inner Casing Panel Seal

For access, refer to section "General".
Remove the inner casing panel.
To replace remove the old seal, thoroughly clean the casing surfaces. Fit the new seal, it is supplied to the correct length.
Refit the inner casing panel.
NOTE: Ensure the seal is fitted correctly giving an airtight joint.

Condense Drain

For access, refer to section "General".
Refer to diagram 22.
Remove the clips securing the flexible tubes to the siphon adapter by twisting the clips slightly to disengage the clip jaws from each other.
Remove black flexible tubes from siphon adapter.
Lift off the siphon adapter.
Remove the drain connection downstream of the condense trap.
Remove the two condense trap securing screws. Lift up and carefully remove the condense trap taking care not to spill any water which may be left in the unit. As the unit is lifted remove the flexible pipe on the outlet.
Remove the cap at the base of the condense trap.
Remove any solids found.



Diagram 21

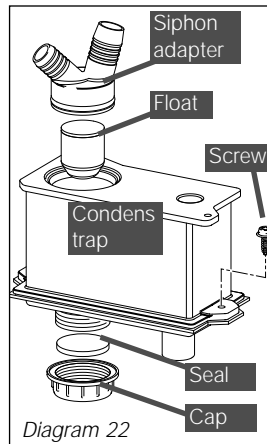

Remove the float to clean it.
Flush water through the trap to remove any remaining solids.
Check for any debris in the outlet pipe of the condensate drain and clean as necessary.
Reassemble and refit the condense trap.
When refitting the cap ensure that a watertight seal

is achieved, but do not use excessive force.
Remove the siphon adaptor from the flexible tubes, using a suitable container, flush the heat exchanger until the water appears clear in the container.

Plate-to-Plate Heat Exchanger

For access, refer to section "General".
Drain the boiler heating and hot water circuits.
Remove the water flow sensor, refer to previous section.
Unclip the central heating thermistor.
Unscrew the heating flow pipe union nut, swing pipe forwards.
Remove the system water pressure sensor.
Supporting domestic hot water plate to plate heat exchanger, unscrew and remove two screws securing it onto pump mounting and 3-way valve/bypass housing.
Remove plate to plate heat exchanger from boiler.
Fit replacement plate to plate heat exchanger in reverse order to removal using new seals, supplied.
Note: Plate to plate heat exchanger mounting screws are offset to ensure correct fitting.



Diagram 23

Domestic safety valve (10 bar BLUE), refer to diagram 24.

For access, refer to section "General".
Drain down the hot water circuit only.
Undo discharge pipe union nut.
Pull out slotted metal clip from valve body and remove valve.

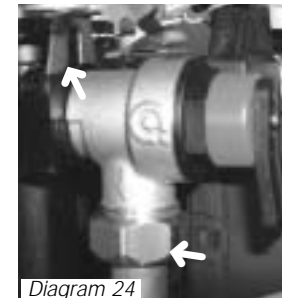

Diagram 24

Micro accumulator vessel thermistor, refer to diagram 25.

For access, refer to section "General".
For this operation the boiler must be removed from the wall.
IMPORTANT: With regards to the manual handling operations, 1992 regulations, the following operation exceeds the recommended weight for one man lift.

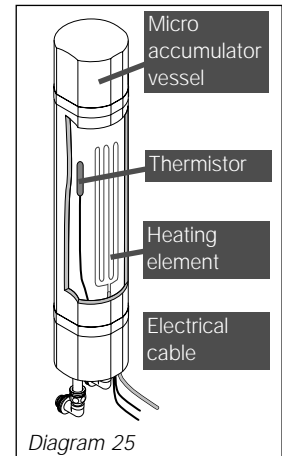

Diagram 25

INSTALLERS

Replacement of parts

Note : It is not necessary to drain down entire heating system to carry out this work.

Disconnect the flue system. Disconnect the boiler connections pipes .

Disconnect the pressure relief valve discharge pipes. Disconnect the mains cable and any external controls cables.

Lift up to remove the boiler from the wall.

Locate micro accumulator vessel thermistor, on side of the micro accumulation vessel.

Disconnect the inline electrical connection plug to the micro accumulator vessel thermistor.

Pull out to remove the thermistor.

Micro accumulator vessel, refer to diagram 25.

For access, refer to section "General".

For this operation the boiler must be removed from the wall, see previous section.

From the rear of the boiler, disconnect the inline electrical connection plug to the micro accumulator vessel thermistor.

Remove the heating element electrical cable.

Unscrew the retaining nuts

pipes.

- Remove the vessel from the boiler.

Micro accumulator vessel heating element, refer to diagram 25.

For access, refer to section "General".

For this operation the boiler must be removed from the wall, see previous section.

Disconnect the electrical connection plug to the micro accumulator vessel heating element at the control board PCB connection.

- Release the micro accumulator vessel heating element cable from the securing clips, note the routing of the cable for reassembly.

- Pull out micro accumulator vessel heating element.

Printed circuit board (PCB), refer to diagram 26

For access, refer to section "General".

Gain access to rear of control panel.

Undo and remove the two front retaining screws.

Hinge up the control panel cover and ease forwards from the rear retaining lugs to gain access to PCB. Do not strain the cables attached to the PCB. Note the routing of the cables.

- Carefully pull off electrical connections to PCB. Unclip and lift out PCB. Fit replacement PCB in reverse order to removal. Be careful not trap any of the cables.

Make sure that PCB connections are fully pushed onto replacement PCB.

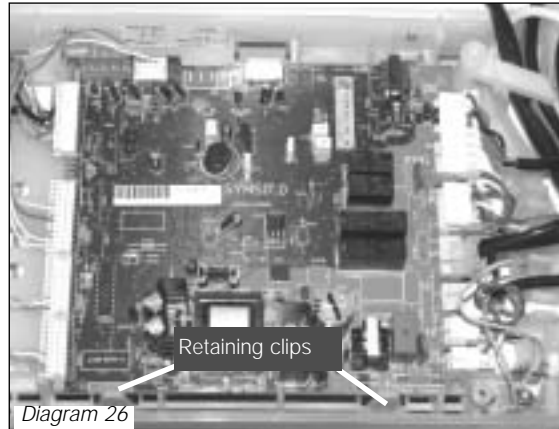

Diagram 26

Spare parts

When ordering spare parts, quote the part number and description, stating the appliance model number and serial number from the data badge.

Short parts list

No.	Description	Part No.	G.C. No.
1	Central heating thermistor	S5739800	••••••
2	Fan	S152000	••••••
3	Domestic water flow sensor	S5720200	••••••
4	Printed circuit board - Main	S1040000	••••••
5	Pump head	S1024000	••••••
6	System water pressure sensor	S5720500	••••••
7	Gas control valve	S1043900	••••••
8	Overheat thermostat	S1040100	••••••
9	Three way valve	S1025500	••••••
10	Pressure relief valve	S1006700	••••••
11	Heat exchanger	S1041100	••••••
12	Burner	S1042200	••••••
13	Micro accumulation vessel	S1025000	••••••
14	Micro accumulation vessel thermistor	S1027300	••••••

Because of our constant endeavour for improvement, details may vary slightly from those shown in these instructions.

**PLEASE DO NOT FORGET
TO COMPLETE YOUR
GUARANTEE REGISTRATION
CARD**



Saunier Duval
S E R V I C E

Saunier Duval's specialist organisation
offering Saunier Duval boiler owners :

- An experienced team of professionally qualified locally based service engineers
- Unrivalled technical knowledge from people who manufactured your Saunier Duval boiler
- FAST response
- Reliable and efficient repairs
- We carry most spare parts on our vans - over 98% of faults are fixed first time round.

Saunier Duval Service N° 01773 525914