

Your Cooker is guaranteed against the cost of breakdown repairs for twelve months from the date of the original purchase.

What is covered?

- Repairs necessary as a result of faulty materials, defective components or manufacturing defects.
- The cost of functional replacement parts, but excluding consumable items.
- The labour cost of a Leisure Consumer Products approved repairer to carry out the repair.

What is not covered?

- Transit, delivery or accidental damage or misuse and abuse.
- Cabinet or appearance parts, including knobs, flaps, handles or container lids.
- Accessories or consumable items including but not limited to filters and light bulbs.
- Repairs required as a result of unauthorized repair or inexpert installation that fails to meet the requirements contained in the user instruction book.
- Repairs to products used on commercial or non-residential household premises.

Important notes

- Your Leisure Consumer Product is designed and built for domestic household use only.
- The guarantee will be void if the product is installed or used in commercial or non-residential domestic household premises.
- The product must be correctly installed, located and operated in accordance with the instructions contained in the User Instruction Booklet provided.
- Professional installation by a qualified Electrical Domestic Appliance Installer is recommended for all Washing Machines, Dishwashers, Electric Cookers and Cooker Hoods.
- Gas Cookers must only be installed by a CORGI (or BORD GAIS) registered Gas Installer.
- The guarantee is given only within the boundaries of the United Kingdom and the Republic of Ireland.
- The guarantee is applicable only to new products and is not transferable if the product is resold.
- Leisure Consumer Products disclaims any liability for incidental or consequential damages.
- The guarantee does not diminish your statutory or legal rights.

Please keep your purchase receipt or other proof of purchase in a safe place; you will need to have it should the product require attention under guarantee.

You should also complete the details below; it will help us assist you when requesting service. (The model is printed on the Instruction Booklet and Serial Number is printed on the Rating Label affixed to the appliance)

Model No: _____	Serial No: _____
Retailer: _____	Date of purchase: _____

For service under guarantee simply telephone the appropriate number below

UK Mainland & Northern Ireland

Fridges & Freezers	0845 600 4903
Electric Cookers	0845 600 4921
Gas & Dual Fuel Cookers	0845 600 4921
Washing Machines & Dishwashers	0845 600 4906

Republic of Ireland

All Refrigeration,	01862 34 11
All Cookers,	
Washing Machines & Dishwashers	

Before requesting service please check the trouble-shooting guide in the Operating Instructions as a charge may be levied where no fault is found even though your product may still be under guarantee.

Service once the manufacturer's guarantee has expired

If you have purchased an extended guarantee please refer to the instructions contained within the extended guarantee agreement document. Otherwise please call the appropriate number above where service can be obtained at a charge.

Should you experience any difficulty in obtaining service please contact the Leisure Consumer Products Customer Help-Line.

Tel: 0845 600 4918 e-mail: service@leisurecp.co.uk

Dear customer

Congratulations on your choice of a quality cooker which has been designed to give you lasting service.

The cooker must be installed by a qualified person in accordance with current regulations and used in a well ventilated space.

Please read these instructions thoroughly before installing or using and keep for handy reference. Make sure you understand the controls prior to using your appliance. This cooker must only be used for its intended purpose, ie the cooking of food in the home. Failure to observe these instructions may invalidate your right to free service during the guarantee period.

If you have any questions, or if you are not sure about any information contained in this booklet please contact us - details are on the back cover.

Leisure Consumer Products

safety symbols

The use of any appliance and cookers in particular (which use gas and high temperatures) require the following of basic common sense safety rules.

There is a danger of injury to the person and of damage to the cooker, the kitchen and your home.

These are itemised in the first section 'Safety in the home'. Where accidents are most common, we repeat these warnings in the main text using the following symbols:



Where you, other people, toddlers and children are at risk



Where there is a danger of damage to the cooker, utensils, surrounding areas and property

Please note them for your own safety.



Introduction

Welcome/Safety symbols	2
Safety in the home	4

Installation

Know your cooker/Specification	6
Location/Ventilation	7
Installation	8
Electrical connection	9
Gas connection	10

For the very first time

Preparation and burning off	11
-----------------------------	----

Operating

Operating the hob	12
Saucepans/Deep fat frying	13
Operating the grill	14
The main oven handyrack	16
Operating the ovens	17
Operating the clock/programmer	18 - 22

Cooker care

Care & cleaning	23
Trouble shooting	24
Replacing the oven lamp	24
Future transportation	24
Guarantee/Service	25

If the cooker does not work

If the appliance does not operate check whether:

- The power and gas supply are on.
- The fuse has blown/circuit breaker has tripped/main distribution switch has been turned off.
- The temperature control has been set correctly.
- The main oven will not light has the clock been set.
- If the clock programmed for auto cooking; the ignition is operating continuously. Check your electric power supply earthing system. This cooker must be earthed if in doubt consult a qualified electrician.

If the appliance is still not operating after the above checks, please refer to the section on how to obtain service.

Please ensure that the above checks have been made as a charge will be made if no fault is found.

Performance characteristics when in use

- **When using your appliance for the first few times, an odour and/or smoke may be emitted which is normal** - see page 12.
- It is normal for the metal parts to produce noise when in use, this is due to expansion and contraction.
- When in use, steam may be produced which is normal and not a fault of the cooker.
- At the end of a cooking session, it is normal to have a momentary puff of steam when the oven door is opened. This should disperse in a few seconds.
- If, whilst cooking, steam produced comes in to contact with cool surface's on the outside of the appliance, it will condense and produce water droplets. This is quite normal and is not a fault.

replacing the oven lamps

Switch off at the mains.

- 1 Remove the glass cover of the lamp by turning it anti-clockwise.
- 2 Remove the bulb by turning it anti-clockwise.
- 3 After installing the correct bulb, reinstall the glass cover.

Replacement light bulbs can be easily obtained from a good local electrical or DIY store.

future transportation

Keep the original carton and other packaging material in a safe place. Transport the cooker in its original carton. Follow the instructions that are printed on the carton.

To prevent the accessories inside the oven from damaging the oven door, tape a strip of cardboard onto the inside of the oven door that lines up with the position of the trays. Tape the oven door to the side walls.

If you do not have the original carton

Take the necessary precautions in order to prevent the exterior panels, and the glass surfaces of the oven from being damaged.

Pack the oven in bubble wrap or thick cardboard and tape it securely in order to prevent damage during transportation.

The oven must be transported upright. Do not place other items on the top of the cooker.



- Turn OFF at the mains before cleaning.
- Before switching on again ensure that all gas controls are in the OFF position.
- Make sure that the oven, grill and burners are sufficiently cool before you start cleaning.
- A residual heat will remain after you switch off the cooker so take care not to touch hot surfaces.

Exterior

Use a damp cloth to clean the outside. Never use any sharp instruments, abrasive household cleaner, or detergents for cleaning. For hard stains use suitable washing liquid.

Burners

The pan supports can be removed and the top burner plate can be cleaned with soapy water and rinsed with a dry cloth.

Wash and rinse the gas burner caps and the pan supports with soapy water. Never wash them in a dishwasher. For the dirt and stains on the burner heads that does not wash off, use a proprietary metal surface cleaner.

Hob surround

Clean with a cloth wrung out in soapy water. Stubborn stains can be removed with a cream, paste or liquid cleaner. Check that the cleaning agent used is approved by the Vitreous Enamel Development Council.

Control panel

Wipe over the control panel with a damp cloth and polish with a dry cloth. Do not use oven cleaners or aerosol sprays, scouring pads or abrasive powder for cleaning the plastic knobs or end caps as damage will occur. Take extreme care when removing and re-fitting control knobs. Never operate the appliance without all control knobs fitted. The correct control knob must be fitted to the corresponding control.

Grill and oven interiors

Take out all trays and pans. Clean out the interior with a piece of moist, soapy cloth. Then, clean it once more with a wet piece of cloth and leave it to dry.

We recommend that grill elements be wiped with a damp cloth to remove any fat splashes. This will prevent fumes from any fat being burned off when the cooker is next used.

Never clean the inside of the grill or oven and trays with hard brushes, steel pads or knives.

Do not use cleaning agents containing acid or chlorine on the handle. Cleaning can be performed using a soft piece of cloth and soapy water or commercially available special surface cleaners.



Grill and oven doors

Wipe over the door outer panel with a cloth wrung out in hot soapy water, then after wiping with a cloth wrung out in clean water, dry with a soft clean cloth. Do not use scouring pads or abrasive powder which may scratch the surface. Take care during cleaning not to damage or distort the door seal.

Ensure that the door seal is dry after cleaning. Do not lift the door seal.

Models with removable inner glass panels

When you wish to clean the interior glass of the oven door, use a screwdriver to remove the top and bottom washers that secures the interior glass to the door, remove the glass with care.

Clean as above, but do not use house hold detergents, bleach, scouring pads or rust removers. After drying, position the gasket back into its place, reinstall the glass panels carefully preventing sudden shocks.

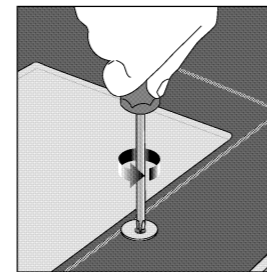

* If low emissive glass is fitted, ensure the printed side is facing outwards.

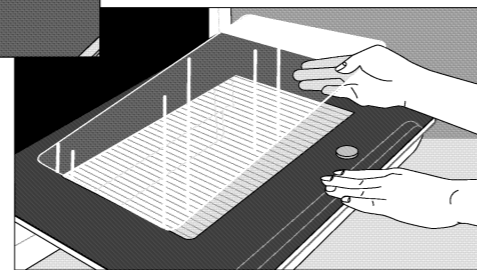

Glass lid

Do not use the following to clean the glass lid; house hold detergents, bleach, scouring pads, rust removers or metal scrapers.

To clean use warm soapy water and dry using a cotton cloth or paper towel roll.

Do not apply excessive pressure to the glass lid when in the up position.

Over time...

- Slight discolouration of liners and other surfaces may occur in time. This does not affect the functioning of the appliance.

* Model dependant.

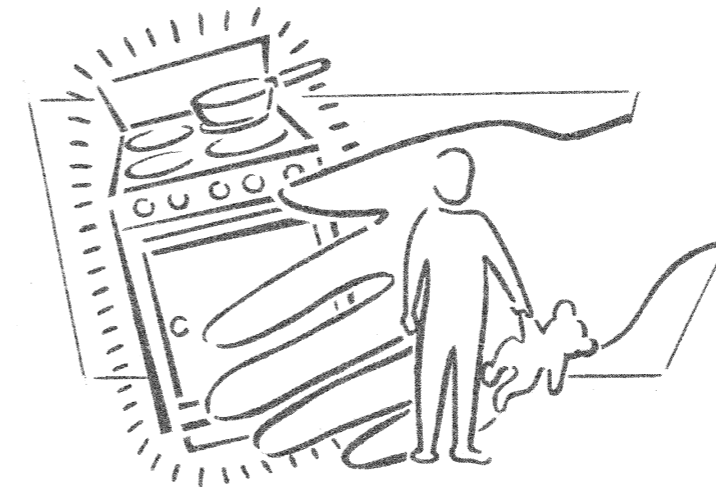

Look after yourself, family and friends

- Ensure that children are kept away whilst the cooker is in use and until it has cooled as parts become very hot. Don't leave them unsupervised.
- During use surfaces get hot. Don't touch hot surfaces during use.
- Close supervision while cooking is essential at all times.
- Never use when judgement or co-ordination is impaired by the use of alcohol and/or drugs.
- Don't use aerosol sprays near the cooker as most are highly inflammable.
- Special care should be taken when cooking oily and fatty food as overheating of such food can cause them to catch fire.
- Always use good quality oven gloves when removing hot utensils and the grill pan from the oven.
- Ensure handles of pans can not accidentally be caught or knocked and do not get heated by adjacent burners.
- Check all controls on the appliance are switched off after use.
- Take care when opening the door. Let steam and hot air escape before removing the food.
- Select the correct shelf position before turning the oven or grill on - don't move oven shelves when hot.
- Don't use water to extinguish oil or fat fires.
- Don't heat up unopened food containers as pressure can build up causing the container to burst.

- Don't use round-bottomed traditional woks. Use flat-bottomed types.
- Don't store items above the cooker that children may try to reach.

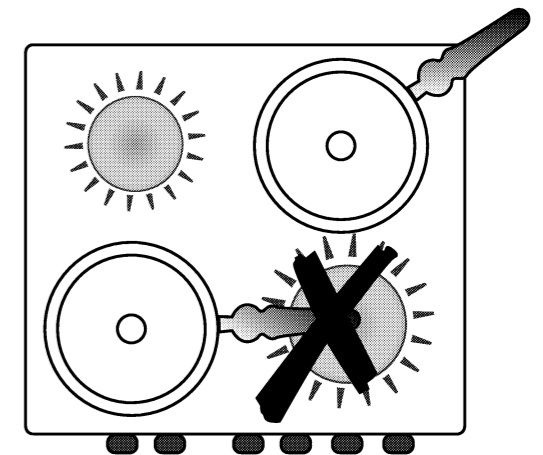

safety in the home

Look after your cooker and home



- Clean your cooker regularly, ideally after each use. Always turn off the mains electricity supply and make sure pan supports, burners and other surfaces are cool before touching them.
- Spillage should be dealt with as soon as it occurs, taking due care as the hob surface may be hot. Any spillage left on the surface after cooking should be cleaned off before the hob is turned on again to prevent baking on.
- Don't use biological washing powder or bleach products, harsh abrasives or chemical cleaners for cleaning the oven inner panels.
- Don't allow anyone to sit or stand on the cooker or door.
- Don't move the cooker by pulling by the door and/or handle.
- Ensure that no flammable materials are adjacent to the cooker as the sides become hot during use.
- Don't store flammable materials, aerosols etc in adjacent cabinets.
- Don't place flammable or plastic items on or near the hob, and never place wet cloths etc. on the hob to dry.
- Keep all ventilation slots clear of obstructions.
- Don't leave a burner on for long periods when not covered by a pan.
- Don't cover shelves with metal foil as the air circulation in the oven will be disrupted.
- Don't place dishes, pans, trays directly on the oven compartment base.
- Don't line the grill pan with aluminium foil this will result in an increase in temperature and could result in damage to your cooker or increased risk of fire.
- Don't use the cooker with glass windows removed.

Don't use the cooker for

- Hanging towels and dish cloths etc on the handles.
- Warming plates under the grill.
- Heating the kitchen.
- Drying.
- Storage of flammable materials or liquids in the storage compartment.

Food hygiene

- Ensure meat and poultry is thoroughly defrosted before cooking.
- Check food is thoroughly cooked and is piping hot.
- **Always refer servicing to a qualified appliance service engineer.**



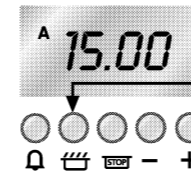

At the end of the cook period the **A** symbol will flash and an intermittent beeping sound will be heard. The  symbol will go out. The beeping sound will continue for several minutes unless cancelled (see Step 6). The **A** symbol will continue to flash until the timer is returned to manual operation (see below).



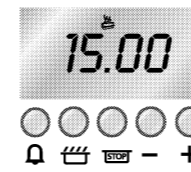

Step 6 Press the  cook period button to cancel the beeping.



Step 7 Turn the oven control to the OFF position.

Step 8 Press the  cook period and end time buttons together to return the cooker to manual operation. The **A** symbol will go out and the  symbol will light up.

When cooking automatically the cook period can be checked at any time by simply pressing the  cook period button. To cancel the auto cooking programme before or after automatic cooking starts, press the  cook period and  end time buttons together. This will return the cooker to manual operation.



At the end of the automatic cook period the **A** symbol will flash and an intermittent beeping sound will be heard. The symbol will go out.

The beeping sound will continue for several minutes unless cancelled (see step 8). The **A** symbol will continue to flash until the timer is returned to manual operation (see below).

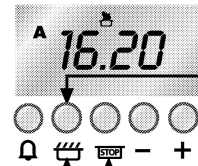

Step 8 Press the cook period button to cancel the beeping sound.

Step 9 Turn the oven control to the OFF position.

Step 10 Press the cook period and end time buttons together to return the oven to manual operation. The **A** symbol will go out and the symbol will light up.

Notes:

When cooking automatically the cook period can be checked at any time by simply pressing the cook period button and the end time button. To cancel the auto cooking programme before or after auto cooking starts, press the cook period and end time buttons together. This will return the cooker to manual operation.

(b) To set the timer to switch ON immediately and OFF automatically after a set cook period.

Step 1 Check that the correct time of day is set. If not follow instructions for setting the time of day.

Step 2 Place food onto the correct shelf position in the LHS oven and close the oven door.

Step 3 Turn the LHS oven control to the required temperature. The oven will automatically ignite.

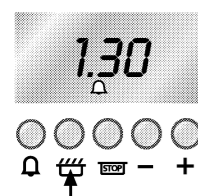

Step 4 Press and hold the cook period button, the display will read **0.00** and the symbol will light up.

Note: The cook period is the length of time the food requires to cook.

With the cook period button still held set the required cook period using the "+" and "-" buttons the **A** symbol will light up. **e.g.** 1 hour 30 minutes.



Step 5 Release all buttons.

The timer display will revert to the time of day with the **A** and symbols remaining lit.



Some of the illustrated details may vary

specification

External dimensions width x depth x height
1000mm x 600mm x 900mm

Cooker height with glass lid raised 1480 mm.

Front-right burner	1.0 kW
Rear-right burner	2.0 kW
Front-left burner	2.0 kW
Rear-left burner	3.0 kW
Center (Wok) burner	3.3 kW
Warming plate wattage	80 W
Supply voltage	230V~ 50Hz
Main oven burner (Left Hand Side)	2.5 kW
Oven burner (Right Hand Side)	2.5 kW
Grill burner	2.3 kW

Lamp	25W x 2
Total power (gas)	18.6 kW
Ignition	Auto electric on all burners
Safety device	Gas valves are lockable

Gas Supply Pressure	Destination Countries
G20 20 mbar	GB
I 2H AT 20 mbar	

For Cooker set up condition please refer to rating label

Because we continually strive to improve our products, we may change our specifications and designs without prior notice.

Accuracy

Note that times and temperatures in this book are for guidance only.

location

- The cooker is designed to fit between kitchen cabinets spaced over 1000 mm apart. The space either side of the cooker need only be sufficient to allow withdrawal of the cooker for servicing. It can be used with cabinets on one side or both sides as well as in a corner setting. It can also be used free-standing.
- Adjacent side walls above the appliance must not be nearer to the cooker than 100mm and should be of heat resistant material. Leave at least 750 mm clearance above the hob.
- Excess steam from the oven is expelled at the rear of the appliance therefore the wall behind the cooker needs to be protected against grease and moisture.
- The cooker should not be placed on a raised base.

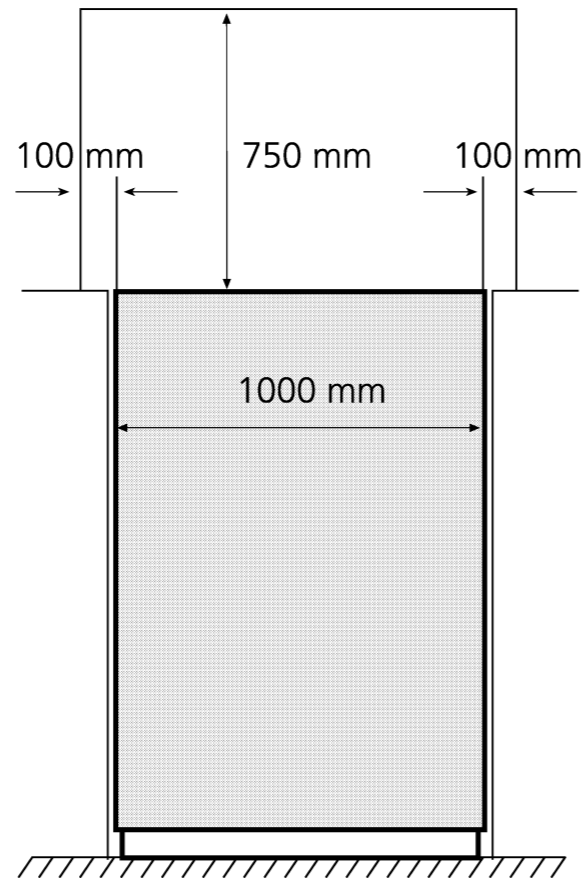

ventilation

Natural ventilation is important for the correct functioning of the appliance and your own safety.

Prolonged intensive use of the appliance may call for additional ventilation, for example the opening of a window, or the use of permanent fixed mechanical ventilation system, for example, an extractor fan or cooker hood that ventilates to the outside.

Room considerations and built-in ventilation

The appliance must not be installed in a room without a window or other controllable opening. If it is installed in a room without a door which opens directly to the outside, a permanent opening is required. The size of the free area of a permanent opening must be as follows:

Room volume	Opening
Up to 5m ³	100cm ²
5m ³ to 10m ³	50cm ²
Above 10m ³	None
In cellar or basement	65cm ²

These requirements apply for a full cooker equivalent, however if there are other fuel burning appliances in the same room. The regulations in force for the UK and Ireland should be consulted.

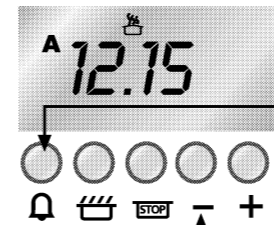

To cancel the minute minder before the minute minder period has finished.

Step 1 Press the  minute minder button.

Step 2 Press the “-” button until 0.00 and the  symbol appears in the display window.

Step 3 To cancel the beeping sound press the  minute minder button.

Automatic Cooking Programmes

The LHS oven only is programmable.

When the timer has been set for the LHS oven it is possible to use the RHS oven manually during the same automatic programme.

There are two automatic cooking programmes that can be selected using your timer:

(a) To set the timer to switch the oven ON and OFF automatically.

(b) To set the timer to switch on immediately and OFF automatically after a set cook period.

Note

When the minute minder has been set the time remaining can be checked at any time by simply pressing the  minute minder button.



(a) To set the timer to switch the oven ON and OFF automatically.

This allows you to cook at a specific time for a chosen period before the oven switches off automatically.

Step 1 Check that the correct time of day is set. If not follow instructions for setting the time of day.

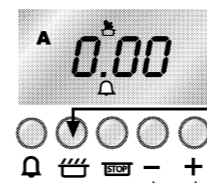
Step 2 Place food onto the correct shelf position in the oven and close the oven door.





Step 3 Press and hold the  cook period button. The display will read 0.00 with the cookpot symbol  lit.

Step 4 With the  cook period button still held in set the required cook period using “+” and “-” buttons.

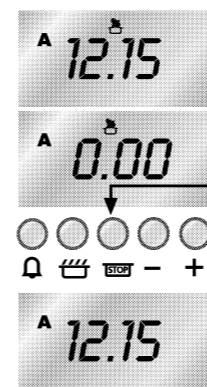
➔ Release the buttons and the timer display will revert to the time of day with the **A** symbol and  symbol lit.



Step 5 Press and hold the  end time button. The display will read the earliest possible time for the cook period that you have set above.

Step 6 With the  end time button stillheld in, use the “+” and “-” buttons to set the end time. **i.e.** The time you require the oven to switch off and the food is cooked.

➔ Release all the buttons and the timer will revert back to the time of day.

The **A** symbol will remain lit to signify that an automatic cooking programme has been set. The  symbol will go out.

Step 7 Turn the oven control to the required temperature.

When the auto cook programme starts the  symbol will then light up again.

Setting the Time of Day

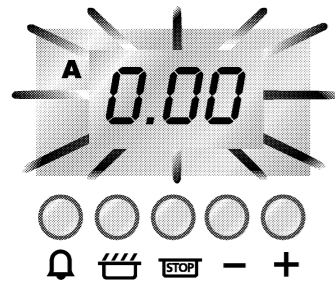

Step 1 Make sure all oven controls are turned **OFF**.

Step 2 Check the electricity supply to the cooker is turned **ON**.

When switched on the display will show **0.00** and the **A** symbol, both will be flashing.

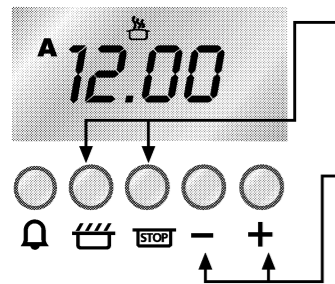

Step 3 Press hold in both the cook period & end time buttons together.

Step 4 With the cook period & end time buttons still held in, press either + or - buttons to set to correct time of day.

Step 5 Release all the buttons simultaneously.

The time of day is now set and the symbol will light up to show that the timer is in Manual Mode.

NOTE: To change the time of day repeat steps 3, 4 & 5 above.

Setting the Minute Minder

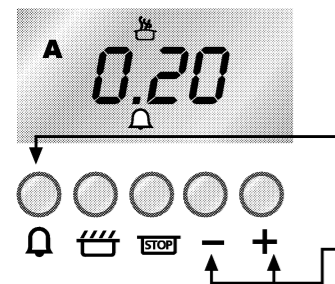

Step 1 Ensure the time of day is set correctly.

Step 2 Press and hold the minute minder button.

Step 3 With the button still held in set the required minute minder time using "+" and "-" buttons.
A symbol will light up.

Step 4 Release all buttons and the timer display will revert back to the time of day.

The symbol will remain lit to signify that a minute minder period has been set.

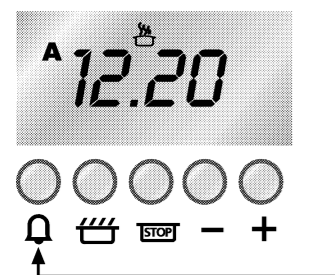

At the end of the set time a bleeping sound will be heard and the symbol will go out.

The bleeping sound will continue for several minutes unless cancelled (See Step 5)

Step 5 To cancel the bleeping sound press the minute minder button. The time display will revert back to the time of day after the button is released.

Unpacking

All packing materials, protective film and transit protectors must be removed.

Installers



The appliance must only be installed by a competent person.

In the UK, CORGI registered installers (including the Regions of British Gas) undertake to work to safe and satisfactory standards.

Regulations

The cooker must be installed in accordance with the Gas Safety (Installation and Use) Regulations and the relevant Building Regulations in force.

Levelling

The appliance should be located on a level surface. The two front and rear feet can be adjusted as required. To ensure that your appliance is standing level adjust the two front or rear feet by turning clockwise or anticlockwise until the product is in firm contact with the floor.

Stability Chain

The cooker must be secured by the security chain to the wall or partition behind the cooker.

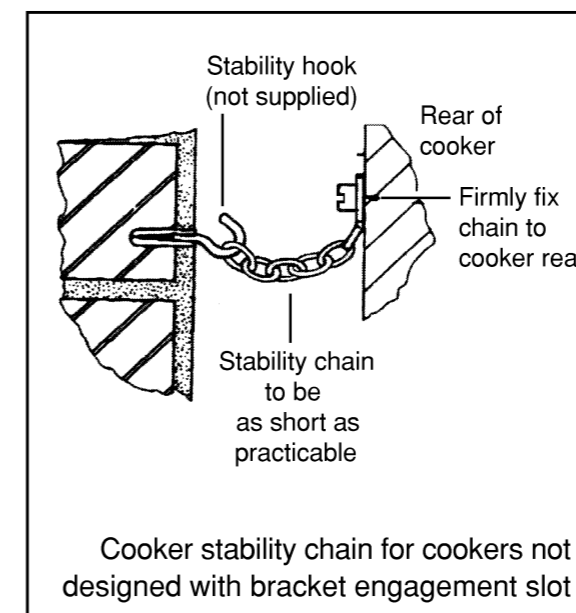

Moving your cooker

If your cooker is fitted with a flexible hose the cooker can be moved for cleaning. Make sure that the floor covering is firmly fixed or removed to prevent it being disturbed.

TAKE CARE NOT TO STRAIN OR DAMAGE THE GAS HOSE (OR ELECTRICITY SUPPLY CABLE) WHEN MOVING THE COOKER.

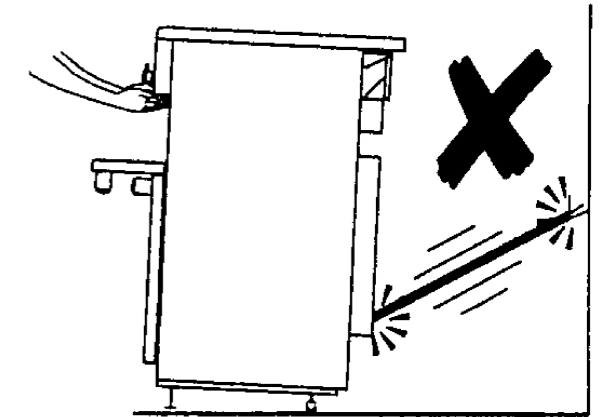

Release the stability chain as you ease the cooker out. Don't forget to refit it when you replace the cooker.

Lift the front feet clear off the floor by lifting at the ends of the hotplate fascia. Do not move by pulling the door handle or knobs.

Move the cooker a bit at a time, checking behind it to make sure that the gas hose has sufficient slack to allow the cooker to move forward as you go along.

When you replace the cooker, again check behind to make sure that the gas hose or cable are not caught or trapped. Take care not to twist it within the gap between the kitchen units as damage may occur to the cooker or the units.

Check that the cooker stability chain has been reconnected.

Electrical requirements

Before you insert the plug into the wall socket make sure that the voltage and the frequency shown in the rating label corresponds to your electricity supply.

We recommend that this appliance be connected to the mains supply via a suitable switched and fused socket in a readily accessible position.

Should the mains lead of the appliance become damaged or need replacing at any time, it must be replaced by a special purpose made mains lead which can only be obtained from a Leisure consumer products Authorised Service Agent.



Warning

This appliance must be earthed

If the fitted moulded plug is not suitable for your socket, then the plug should be cut off and an appropriate plug fitted.

Destroy the old plug, which is cut off as a plug with a bared cord could cause a shock hazard if inserted into a socket elsewhere in the house.

The moulded plug on this appliance incorporates a 13A fuse. Should the fuse need to be replaced an ASTA approved BS1362 fuse of the same rating must be used. Do not forget to refit the fuse cover. In the event of losing the fuse cover, the plug must not be used until a replacement fuse cover has been fitted. Colour of the replacement fuse cover must be the same colour as that visible on the pin face of the plug. Fuse covers are available from any good electrical store.

Ignition

The ignition system is reliant on the cooker being plugged in to suitable mains power supply which is switched on.



Important Fitting a different plug

As the colours of the wires in the mains lead of this appliance may not correspond with the coloured markings identifying the terminals on your plug, proceed as follows:

- 1 Connect the green - yellow or green (earth) wire to the terminal in the plug marked 'E' or with the symbol  or coloured green and yellow or green.
- 2 Connect the blue (neutral) wire to the terminal in the plug marked 'N' or coloured black.
- 3 Connect the brown (live) wire to the terminal in the plug marked 'L' or coloured red.

With the alternative plugs a 13A fuse must be fitted either in the plug or adaptor or in the main fuse box. If in doubt contact a qualified electrician.

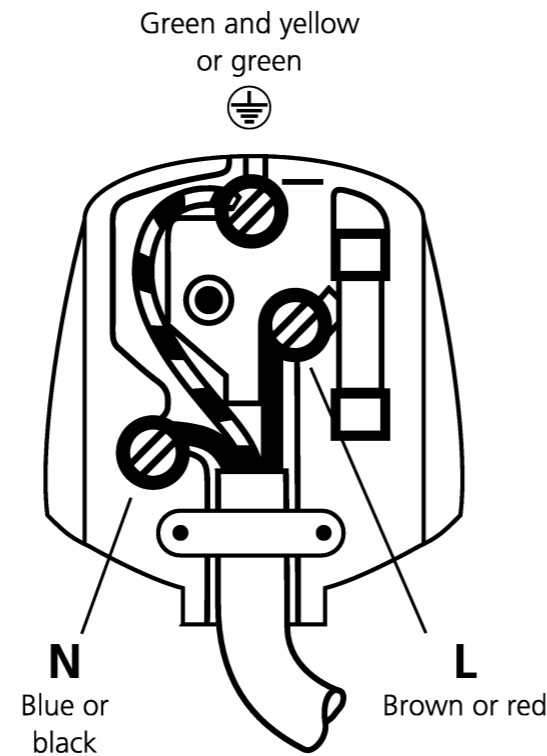

Mains cable routing

The mains cable should be routed away from the appliance, the ventilation slots and the vent outlet. It should not be obstructed when pushed in to position between the appliance and the wall.





The timer display is in 24 hour clock format.

Ensure that the correct time of day is always set before using your cooker. The clock must be set before the LHS oven can be operated.

A will light:

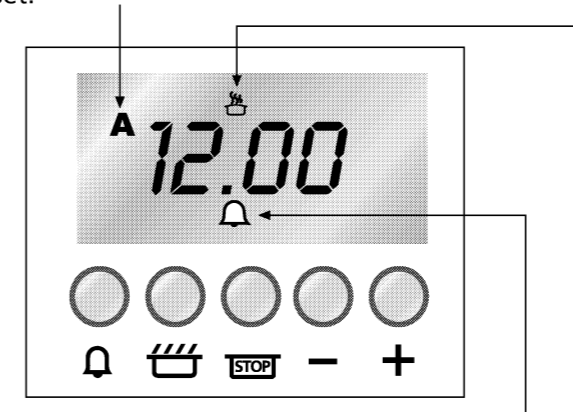
- When the timer is first turned on it will flash. (It should go out when the time of day is set).
- When an Auto Cooking programme has been set.



 This "Cookpot" symbol will light up either.

- When the cooker is in "Manual Mode".
- When you press the  Cook Period button and set a length of time for an Automatic Cooking programme.

 **symbol will light up during Automatic Cooking.**

 will light up when you select a Minute Minder period and will remain on for the period set.

minute minder

Here you can set a time period of up to 23 hours and 59 minutes that will count down. When it reaches zero the timer will bleep. e.g. If you set 20 minutes, the timer will start bleeping 20 minutes later.

cook period

Cook Period is the actual length of time for which, the timer will switch the oven on as part of an "Automatic Cooking" programme. e.g. If you set 2 hours, the food will be cooked for 2 hours.

end time

The time of day at which you want an automatic cooking programme to **end**.
e.g. If you set a cook period for 2 hours, and end time of 11:00. The timer will switch the oven on at 9:00 and turn the oven off at 11:00. You will hear a bleep at 11:00 to indicate that the automatic cooking programme has finished.

Notes

- When setting an automatic cooking programme you will need to set the oven control to the required temperature when you set the timer.
- If an automatic cooking programme has been set the oven will only operate during the pre-programmed time.

"+" and "-"

- Used to adjust the various timer function settings.
- Used to adjust pitch of audible tone.

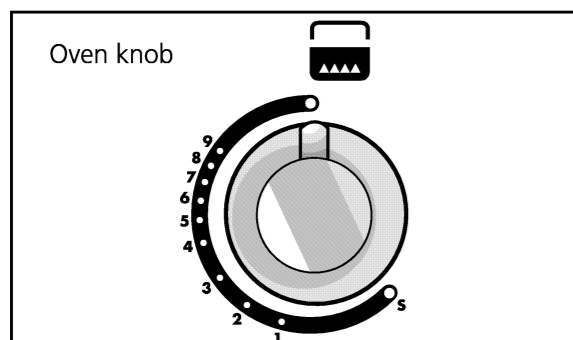

The clock must be set to the current time before the LHS oven can be operated (see page 18).

Parts may become hot when the ovens are in use, children must be kept away.

In the LHS oven, there is a safety device that prevents the build-up of gas inside the cavity if the burner doesn't light or goes out for any reason.

- 1 Open the door.
- 2 Adjust the shelves to the positions required.
- 3 Press and turn the control anti-clockwise to gas mark 7.

Left Hand Side oven,

4 In the LHS oven, there is an automatic ignition system which starts clicking when the oven is turned on and stops when the oven burner lights.

Please note the main oven will not work until the clock has been set to the current time.

- If the burner doesn't light the first time, restart the ignition once or twice again by turning the knob off and on. If it still doesn't light, turn off and wait for 1 minute to allow gas to disperse before trying again.

Oven temperature chart

This chart is for guidance only, follow food manufacturers recommendations whenever available.

Food	Gas mark	Cooking time	Shelf position	Preheat	Gas mark
Beef	4 - 5	25-30 mins per 450g + 30 mins	4	10 mins	7
Lamb	4 - 5	25-30 mins per 450g + 30 mins	4	10 mins	7
Pork	4 - 5	30-35 mins per 450g + 30 mins	4	10 mins	7
Poultry	4 - 5	25-30 mins per 450g + 25 mins	4	10 mins	7
Casseroles	2 - 3	1.5-2 hours, dependant on quantity	3- 4	No	
Fruit cake	2 - 3	Dependent on size	2-3	10 mins	7
Small cakes	4 - 5	15-20 minutes	2-3	No	
Victoria sandwich	4 - 5	22-28 minutes	4	10 mins	7

Right Hand Side oven,

4 When using the RHS oven; while keeping the knob depressed, press the ignition button to light the burner.

Then keep the control depressed for 15 seconds after the burner has lit to over-ride the safety device.

- 5 Close the door.
- 6 Allow 10 minutes for pre-heating.
- 7 Set the knob as required or as recommended in the chart.
- 8 To switch off turn the knob clockwise to the ● off position.

- Ensure you stand back from the appliance when opening the oven door to allow any build up of steam or heat to escape.
- Check food is thoroughly cooked and is piping hot.
- Do not heat an unopened glass or metal container in the oven.
- Do not allow spillovers to accumulate as these may present a fire hazard.
- The oven has several openings and vents designed in. They must not be blocked or covered.
- Do not use aluminium foil on the oven bottom.

Light button

Switches the oven light on or off.

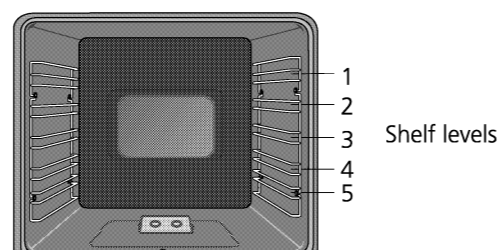

Gas supply

Your oven must only be used on natural gas.

Natural Gas

The cooker is designed for UK installation using a flexible connection with tubing in accordance with the regulations in force. Length of 900mm is recommended (Ireland 600 mm).

Gas flexible hose

If a flexible hose is used it must not come into contact with the top 150mm/6 inches (the shaded area on the diagram) of the rear of the appliance.

Do not pass the hose through the hot region behind the oven.

Connection

Connect the flexible gas hose to the oven as follows.

- 1 Use nonsetting gas sealant on the connection to the cooker.
- 2 Connect to the gas supply pipe at the rear of the cooker (1/2 in BSP).
- 3 Assemble burner caps and rings fit pan supports in position. (left and right sides)
- 4 Turn on the gas supply and check for soundness.
- 5 Light two burners and check that the pressure is correct.

Gas leaks

If you smell gas, turn off all gas controls and extinguish any open flame. Open a window to ventilate the room. Don't touch any electrical switches. Contact your local Gas Supplier immediately.

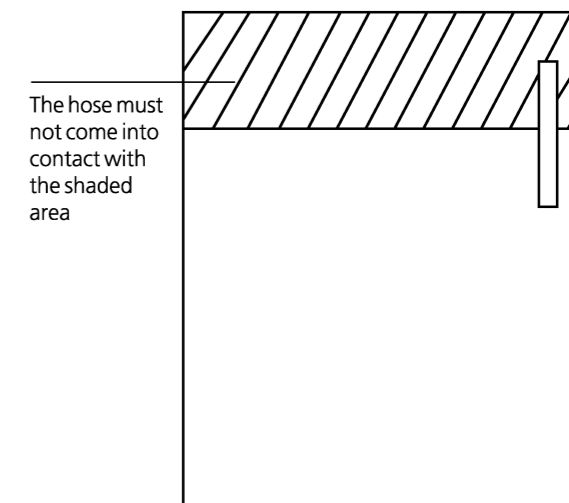

The hose must not come into contact with the shaded area

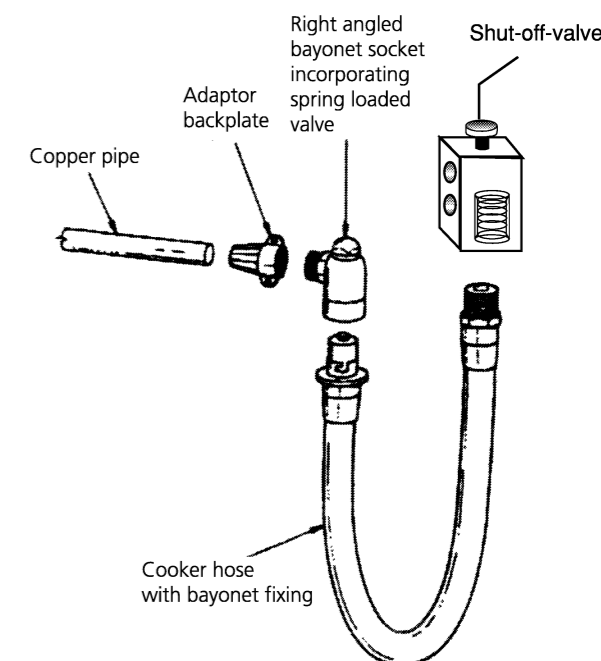



Important for asthmatic sufferers

Before using for the first time, protective coatings need to be burnt off. Fumes will be emitted but this is quite normal.

Ensure the room is very well ventilated during the burning off process. Avoid directly inhaling the fumes during this process.

Grill

Open the grill door. Remove grill tray, wire rack and detachable handle and operate the grill for about 15 minutes.

Oven/s

Remove handy rack, tray and shelf racks and operate the oven at gas mark 8 for 30 minutes.

Cleaning

Before you start using your cooker, clean the appliance as recommended under Care and cleaning on page 23.

Shelf racks

The shelf racks with a heat deflection sheet should be positioned with the heat deflection sheet at the rear of the oven.

Oven burner heat shield positioning

Before you start using your cooker please ensure the main oven burner heatshield is positioned as shown.

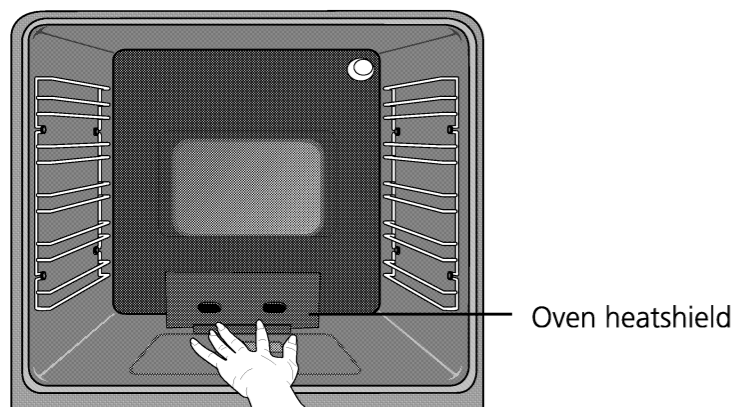

To locate press in the direction indicated above.

The wire shelves should always be pushed firmly to the back of the oven.

Baking trays with food cooking on them should be placed level with the front edge of the oven's wire shelves. Other containers should be placed centrally.

Keep all trays and containers away from the back of the oven, as overbrowning of the food may occur.

For even browning, the maximum recommended size of a baking tray is 350x275mm.

When the ovens are on, don't leave the door open for longer than necessary, otherwise the knobs may get very hot.

The ovens are protected by a safety cut off, which cuts off the supply of gas if the flames go out.

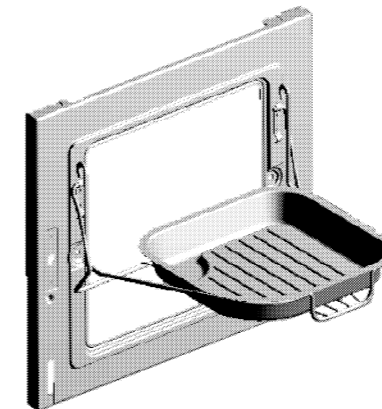

Handyrack

The handyrack fits on the oven door. Food cooking on it is easy to attend to, because it's accessible when the door is open. It can be fitted at two different heights. One of the oven shelves must be removed and the other positioned to suit.

To fit the Handyrack, locate one side of it on the door bracket, then spring the other side out to clip it onto the other bracket.



The maximum weight which can be held by the Handyrack is 5.5 kg (12lb).

When the Handyrack is used in its highest position, other dishes can be cooked on the bottom shelf position of the oven.

When the Handyrack is used in its lowest position, other dishes can be cooked on the second shelf position of the oven.

The roasting tray supplied with the oven fits into the Handyrack.



When the handyrack tray is in use always open and close the door carefully to prevent spillage of hot liquids.

Do not allow excessive amount of hot liquids to accumulate in the handyrack tray, otherwise spillage on the lower shelf positions could occur during opening and closing of the door.

Do not allow children to sit on the handyrack when the door is open.

The door, handyrack and tray get hot during oven operation keep children away whilst the cooker is in use.

Always ensure the oven door is left closed to prevent accidental contact with the handyrack.

Use good quality oven gloves whenever handling the roasting tray.

Tips for cooks

Always leave a 'fingers width' between dishes on the same shelf. This allows the heat to circulate freely around them.

To reduce fat splashing when you add vegetables to hot fat around a roast, dry them thoroughly or brush lightly with cooking oil.

If you want to brown the base of a pastry dish, preheat a baking tray for 15 minutes before placing the dish in the centre of the tray.

Put dishes which may boil and spill over during cooking, on a baking tray.

operating the grill

Use of grill pan handle

Warning! Always use an oven glove to protect your hand when using the grill as all metal parts can become very hot.

The grill pan has a detachable handle. Make sure the handle is securely located between the raised profiles across the front of the grill pan. See the diagrams for fitting the handle. To remove the handle, reverse the sequence of operations.

Always take care not to touch hot surfaces when using the grill pan handle. Ensure when using the grill pan handle that it is centralised and secure. If the handle is left in position when grilling, it will get very hot.

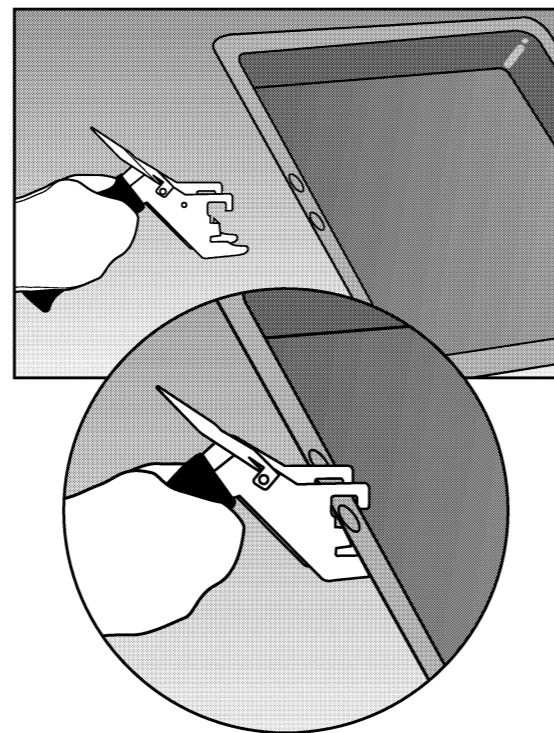

Grilling guidelines

Use the following chart for guidelines.

For thicker foods requiring longer cooking, turn the control to a lower setting after the initial sealing on both sides. The thicker the food, the lower the control should be set. When grilling thicker food, the grill rack should be turned over to its lowest position.

Food	Grill setting	Approximate cooking time
Toasting of Bread products	Full on	3-10 mins
Small cuts of meat, sausages, bacon, etc.	High to Full	15-20 mins
Chops etc. Gammon steaks Chicken pieces	Medium	20-25 mins. Wire rack used in upturned position for chicken.
Fish: Fingers Whole Fillets	Medium	10-20 mins. Whole fish and fillets placed in the base of the grill pan.
Fish in breadcrumbs	Medium	15-20 mins.
Pre-Cooked potato products	Medium	15-20 mins.
Pizzas	Medium	12-15 mins. in the base of the grill pan.
Browning of food	Full on	8-10 mins. Dish placed directly on the base of the grill compartment.

operating the hob

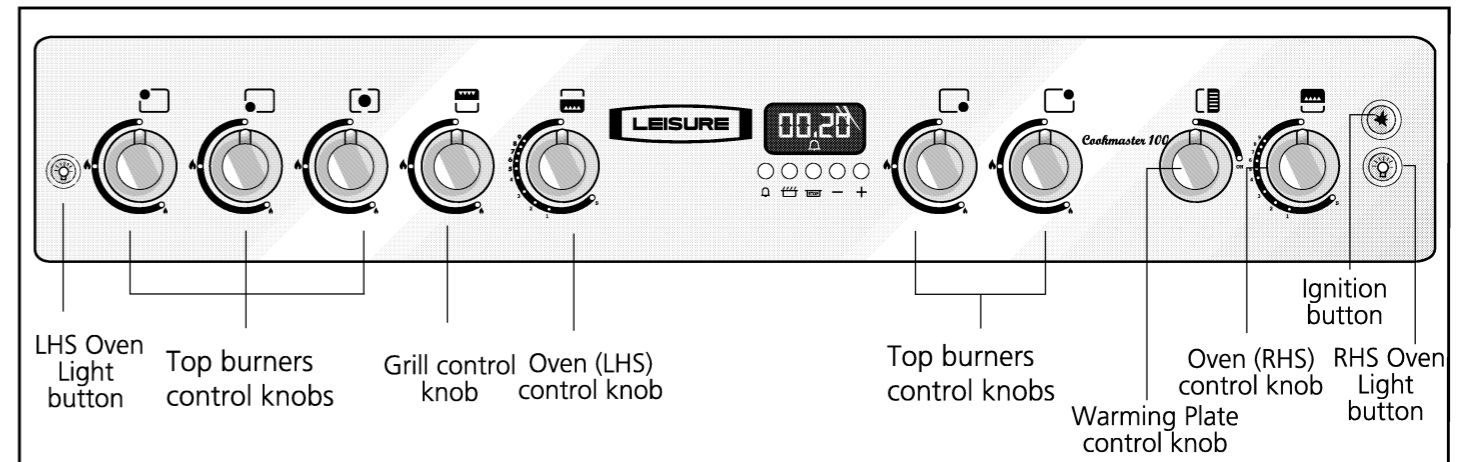

Turning on and off

The burner control knobs have a safety feature.

- 1 Push the appropriate knob in slightly and turn anti-clockwise to the required setting.
 - 2 Press the ignition button.
 - 3 To switch a burner off turn the corresponding knob to ●.
- Turning the control knob fully anti-clockwise to the small flame symbol enables you to simmer without accidentally switching off.



Ignition button

- Pressing this button provides a spark at all burners, only the one turned on will light.
- If an appliance burner doesn't light, press again until it does. After you release the knob, if the ignition does not continue repeat the same process by keeping the knob pressed for 15 seconds. If still no ignition occurs, wait for 1 minute and repeat again.

Warning: Do not keep the knob in pressed position more than 15 seconds.

Glass lid

- The glass lid must be in a fully raised position before the hob burners can be used.
- The glass lid is fitted with a safety device which cuts off the gas supply to the hob burners when the lid is closed. The gas supply is restored when the lid is raised.
- Do not use the safety device to control the hob burners.
 - **Prior to closing the glass lid make sure:**
 - Hob controls are off
 - Cooking utensils have been removed
 - The hob burners have been allowed to cool
 - Always raise the lid during oven or grill operation.

The toughened glass lid is not intended as a work surface, as it becomes hot when any part of the cooker is in use and the surface may be scratched if items with rough or sharp edges are placed on it.

Flame control

- When turning on a hotplate burner, stay and make sure that it has lit, and adjust the flame immediately.
- **Selection of the correct flame height is especially important to safety.** Adjust the burner flame so that it does not extend beyond the bottom of the pan, any higher and the flame becomes inefficient and can be a potential fire hazard.
- To make sure that the cooker is operating safely, periodic checks are advised.
- At low settings, do not leave the burners unattended for long periods of time.
- The burner flames should burn with a visible bluish cone within the main flame, and with no sign of yellowness. If at the first lighting they are very noisy and yellow, turn out at once and check that the burner cap has been correctly replaced. If on re-lighting there is no improvement, ask your supplier to check them. The inner portions of the flames as described above may not be very clear, but this is not detrimental in anyway. The pan supports are not interchangeable.

oven light

- Pressing this button will turn the light on.
- Press again to turn the light off.

Warming plate

Warning! The warming plate gets hot during use.

- Switch clockwise to on.
- Switch anticlockwise to ● off.

saucepans

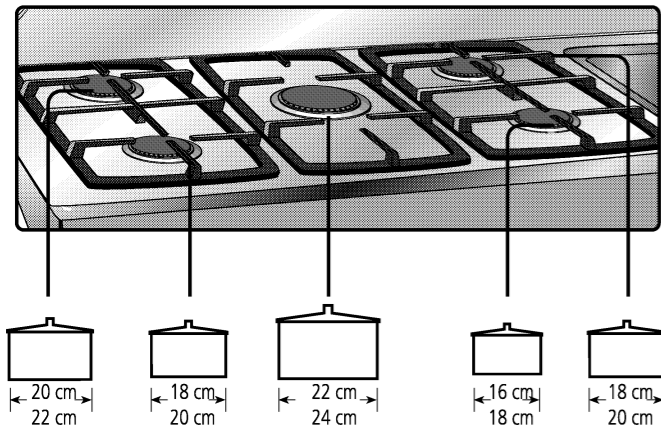

Pan choice

In choosing pans, look for pan handles that can be held easily and will stay cool. Avoid pans that are unstable and easily tipped. Pans that are too heavy to move easily when filled can also be a hazard. Only use flat bottomed pots or pans.

Pan size

For maximum efficiency and safety, use the recommended pan sizes for each burner.

- Use pans which have sufficient capacity for the amount of food being cooked so they don't boil over and cause unnecessary cleaning.
- Do not place lids on the burners.

Always position pans centrally over the burners. When transferring pans from one burner to another always lift the pans do not slide them.

Ceramic hob care

The ceramic glass surface is tough in everyday use and its flat surface makes it easy to clean but please follow the following precautions.

- **Immediately switch off the appliance from the mains if a crack is detected on the ceramic glass surface and refer to the Guarantee section.**
- **Keep children away from hot surfaces.**
- In order to avoid hob soilage, make sure the bottom of the utensils and the hob surface are clean and dry before use.
- Do not use the surface for food preparation eg cutting bread or slicing vegetables and fruit.
- Do not use the surface for storing or any other non-cooking purpose.
- The scratching or dropping of sharp cornered pots onto the surface may cause damage.
- Do not place any material on the surface, such as plastic, aluminium, etc.
- Any such material that may have melted onto the surface should immediately be removed with a hob scraper.
- Never use a dishcloth or sponge to clean the ceramic hob as these may leave a layer of soiled detergent on the hob which will burn and discolour the next time the hob is used.
- Avoid heating up empty enamel pots.
- Splashes may damage the ceramic surface and can cause fire.

In the event of a chip pan or other pan fire

- 1 Turn off the cooker.
- 2 Smother flames with a fire blanket or damp cloth.
- 3 Do not try to remove a burning pan from the hob.

Burns and injuries are caused almost invariably by picking up the burning pan and rushing outside with it.

Do not use water on the fire.
Leave the pan to cool for at least 30 minutes.

operating the grill

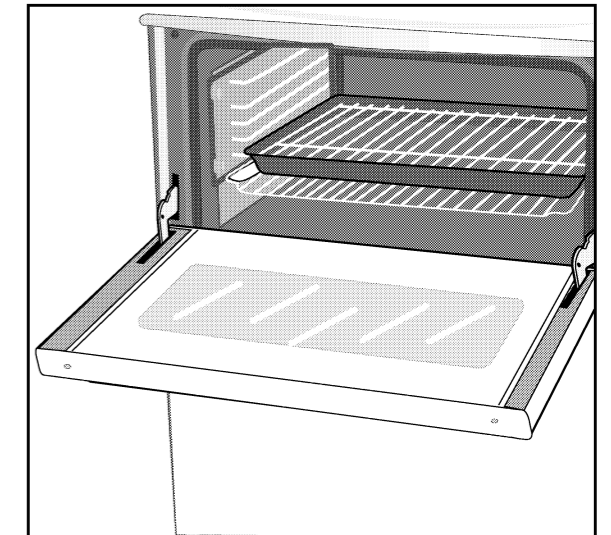
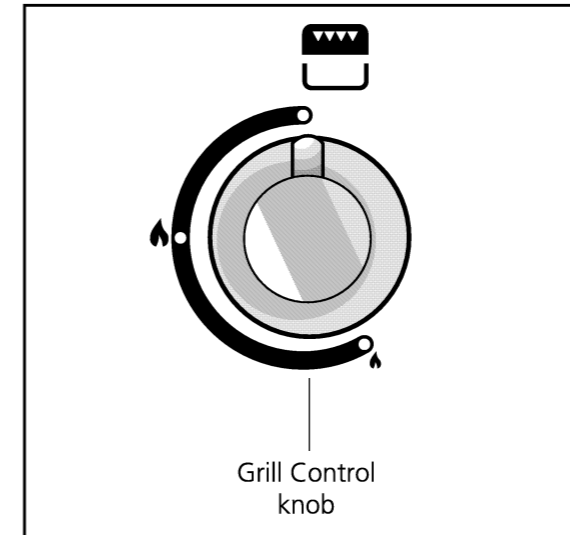

Parts may become hot when the grill is in use, children must be kept away.

When the door is fully open, it remains tilted slightly, so that any spillage will be directed away from you.

There is a safety device that prevents the build-up of gas inside the cavity if the burner doesn't light or goes out for any reason.

Using the grill

The door must be kept open during grilling at all times.

- 1 Open the door.
- 2 Position the shelf in a suitable position.
- 3 Press and turn the control anticlockwise to the large flame symbol.
- 4 While keeping it depressed, press the ignition button to light the burner.
- 5 Keep the control depressed for 15 seconds after the burner has lit to over-ride the safety device.
- 6 Allow the grill to preheat for 3 minutes.
- 7 The grill has a variable control.
- 8 To switch off turn the knob clockwise to the ● off position.

- If the burner doesn't light the first time, press the ignition button once or twice again. If it still doesn't light, turn off and wait for 1 minute to allow gas to disperse before trying again.
- Do not hold the control in for more than 15 seconds.
- Ensure the food is correctly positioned on the grill pan under the grill burner.
- Oiling the grill rack prevents meat sticking on the wires.
- Do not line the grill pan with aluminium foil. This will result in an increase in temperatures and could result in damage to your cooker or increased risk of fire.
- Always remove the grill pan from the compartment as soon as you have finished grilling, it makes the pan much easier to clean. When grilling, if meat is placed too near the grill burner, the fat may ignite.

deep fat frying

- Never fill the pan more than the one-third full of fat or oil.
- Never leave unattended during heating or cooking.
- Do not fry too much food at the same time especially frozen food. This only lowers the temperature of the oil or fat too much resulting in greasy food.
- Always dry food thoroughly before frying and lower it slowly into the hot oil or fat. Frozen foods in particular will cause frothing and spitting if added too quickly.
- Never heat fat or fry with a lid on the pan.
- Keep the outside of the pan clean and free from streaks of oil or fat.