

Technical information

Remeha Gas 310 ECO

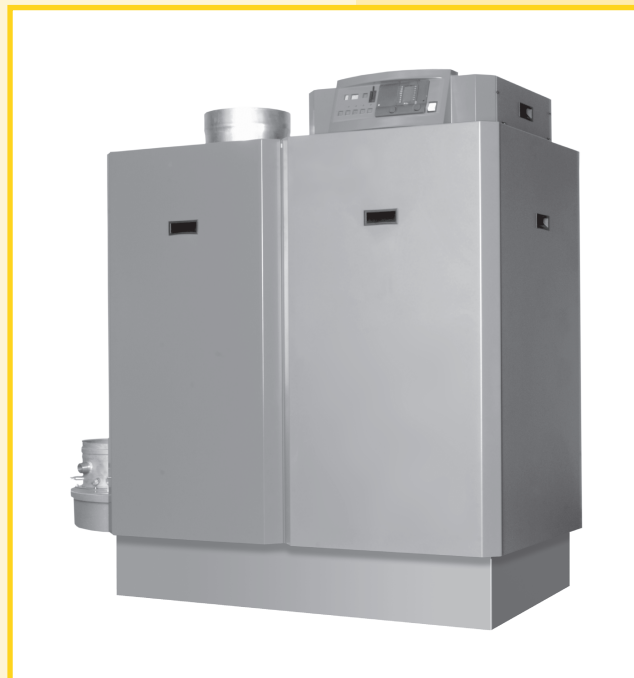

- High efficiency condensing boiler with low NO_x emission
- Heat outputs: 51 - 573 kW



 remeha

Remeha Gas 310 ECO

TABLE OF CONTENTS

Preface	4	8.2.6 Low water level protection (flow and content)	23
1 SAFETY instructions	5	8.2.7 High limit protection	23
1.1 Symbols	5	8.2.8 Air pressure differential sensor (LDS)	23
2 General description of boiler	6	8.3 Connections	23
3 DESIGN	7	8.4 Wiring diagram	24
3.1 Boiler version	7	8.5 Switch sequence diagram	25
3.2 Operating principle	8	8.6 Boiler control	25
4 Technical data	9	8.6.1 Introduction	25
4.1 Dimensions	9	8.6.2 Modulating controls general (two wire control)	26
4.2 Technical data	10	8.6.3 BMS Analog control (0-10 Volt DC)	26
4.3 Quotation specification	11	8.6.4 On/ off control (1 x no volt switched pair)	26
4.4 Delivery options	11	8.6.5 High/ low control (2 x no volt switched pairs)	27
5 Efficiency information	12	8.7 Other inputs	27
5.1 Annual efficiency	12	8.7.1 Shut down input	27
5.2 Heat to water efficiency	12	8.7.2 Lock-out input	27
5.3 Standing losses	12	8.7.3 External interlock	27
6 Application data	12	8.7.4 Other outputs	27
7 Installation instructions for heating installer	13	8.7.5 Analog output	27
7.1 General	13	8.7.6 Operation signal	27
7.2 Delivery and installation	13	8.7.7 Common alarm (lock-out)	27
7.3 Flue gas discharge and air supply	14	8.7.8 External gas valve control	27
7.3.1 General	14	8.8 Options/ accessories	28
7.3.2 Classification due to discharging flue gases	14	8.8.1 System pressure sensor	28
7.3.3 Connection options	15	8.8.2 Gas valve leak proving system VPS	28
7.3.4 Inlets/Outlets	15	8.8.3 Minimum gas pressure switch \\ (suitable for gas pressures up to 30 mbar)	28
7.3.5 Other requirements	15	8.8.4 Flue gas damper	28
7.3.6 Single boiler conventional flue	15	8.8.5 Return butterfly valve (not Broag supply)	28
7.3.7 Single boiler, room sealed flue	16	8.9 Other connections	28
7.3.8 Different pressure zones	18	8.9.1 Boiler or System pump control	28
7.3.9 Header flue systems	18	8.9.2 Frost protection	28
7.4 Installation details	18	9 Installation instructions for gas installer	29
7.4.1 Water pressure	18	9.1 Gas connection	29
7.4.2 Condensate discharge	18	9.2 Gas pressures	29
7.4.3 Water treatment	18	9.3 Gas/ air ratio control	29
7.4.4 Safety valve	19	10 Commissioning	29
7.4.5 Water circulation	19	10.1 Initial lighting	29
7.4.6 Thermostat pocket	19	10.2 Shutdown	31
7.4.7 Noise production	19	11 control and safety equipment	32
7.5 Multiple boiler installation	19	11.1 General	32
8 Installation instructions for ELECTRICAL \\ installer	22	11.1.1 Instrument panel layout	32
8.1 General	22	11.1.2 LED indicators	33
8.2 Electrical specifications	22	11.2 Switch function keys	33
8.2.1 Mains voltage	22	11.2.1 Manual/automatic operation	33
8.2.2 Control unit	22	11.2.2 Forced mode 'high' ( <input type="checkbox"/> <input type="checkbox"/>)	33
8.2.3 Power consumption	22	11.2.3 Forced mode 'low' ( <input type="checkbox"/> <input type="checkbox"/>)	33
8.2.4 Fuse ratings	22	11.3 Display of values	33
8.2.5 Temperature control	23		

12 Operating mode	34		
12.1 Operating mode (X □ □)	34	15.4.7 Cleaning the condensate collector	48
12.2 Read-out mode (X □ □)		15.4.8 Cleaning the syphon	48
12.3 Control strategy (L)	35	15.4.9 Cleaning/Replacing the Ignition Ionisation electrode	48
12.4 Shut-off (b X X)		15.4.10 Gas filter check	49
12.4.1 Shut-off	35	15.4.11 Cleaning the inspection glass	49
12.4.2 Shut-off mode	35	15.5 Exploded view and spare parts list	50
12.5 Counter mode (I I I and I)			
(service level)	36	16 appendices	53
12.5.1 General	36	16.1 Control menu	53
12.5.2 Reading out counter mode	36	16.2 Shut-off codes	54
13 Setting mode	37		
13.1 User level setting mode (X □ □)	37		
13.1.1 Flow temperature (I)	37		
13.1.2 Pump run on time (2)	38		
13.1.3 Boiler control (P)	38		
13.2 Setting mode service level (only for the qualified service engineer) (X □ □)	38		
13.2.1 Minimum fan speed (4 and 5)	39		
13.2.2 Maximum fan speed (6 and 7)	39		
13.2.3 Forced part load time (P)	40		
13.2.4 Cycling prevention delay time (9)	40		
13.2.5 Required flow temperature at 0 - 10 volts (a and b)	40		
13.2.6 Switch point high/low operation signal (L)	40		
13.2.7 Shunt pump post-circulation time (d)	40		
13.2.8 ΔT from control stop point to start point (E)	40		
13.2.9 Maximum flue gas temperature (F)	40		
13.2.10 High limit temperature setting (L)	40		
13.2.11 Modulation start point at dT (H)	40		
13.2.12 Minimum water pressure (I)	41		
13.2.13 Adjustments options/ accessories (J)	41		
13.2.15 Boiler type (P)	41		
14 FAULT-FINDING	42		
14.1 General	42		
14.2 Failure mode (I □ □) (service level)	42		
14.3 Cooling mode	42		
14.4 Summary of failures (lock-out)	42		
15 Inspection and maintenance instructions	46		
15.1 General	46		
15.2 Cooling mode	46		
15.3 Annual Inspection	46		
15.4 Maintenance			
15.4.1 Inspection of air box and dirt trap	47		
15.4.2 Cleaning the non return valve	47		
15.4.3 Cleaning the venturi	47		
15.4.4 Cleaning the fan			
15.4.5 Cleaning the heat exchanger	47		
15.4.6 Cleaning the burner assembly	48		

Remeha Gas 310 ECO

PREFACE

Read these instructions carefully before putting the boiler into operation, familiarise yourself with its control functions, operation and strictly observe the instructions given. Failure to do so may invalidate warranty or prevent the boiler from operating.

The installation and commissioning of the boiler must be carried out by a competent Engineer, with the relevant certification i.e.: CORGI, ACOPS, IEE regs. On completion a copy of the commissioning sheet should be returned to Broag Ltd. for record purposes.

If you have any questions, or if you need more information about specific subjects relating to this boiler or its installation please do not hesitate to contact us.

The data published in these technical instructions is based on the latest information (at date of publication) and may be subject to revisions.

We reserve the right to continuous development in both design and manufacture, therefore any changes to the technology employed may not be retrospective nor may we be obliged to adjust earlier supplies accordingly.



fig. 01 Artist impression Gas 310 ECO
3D.AL.31H.000.S.01

1 SAFETY INSTRUCTIONS

1.1 Symbols

The following symbols are used in this document to emphasise certain instructions. This is in order to increase your personal safety and to safeguard the technical reliability of the boiler.



Instructions must be followed closely to avoid personal injury or serious damage to the unit or the environment.



Important!!

Instructions are of essential importance for the correct functioning of the unit.



Indicates possible danger of electric shock. Serious personal injury may occur.



Instructions contain useful information.

Read and familiarise yourself with these instructions.

General Instructions

Keep unauthorised personnel away from the boiler. Do not place objects on or against the boiler. Do not touch hot water connections or the flue outlet when the boiler is operating – burn hazard.



Danger

This boiler is connected to a 230v mains supply. An improper installation or attempts to repair electrical components or controls may result in life threatening situations.



Be aware of gas escapes

If you smell gas, act as follows:

- Do not smoke and make no fire or sparks;
- Do not operate electrical switches;
- Close the (main) gas cock;
- Open windows and doors;
- Search for a possible leak and seal it up;

Warning! If the gas leak is before the gas meter, alert your gas supplier (Transco 0800 - 111 999).



Be aware of flue gas leaks

If you smell flue gas fumes, turn the boiler off and contact your service company or installer.



Be aware of water leaks

If you see water leaking from the boiler, turn it off and contact your Service Company or installer.



Working on the boiler

Installation, commissioning, maintenance and repair work must only be carried out by suitably qualified specialist. Engineer in accordance with all relevant national/local standards and certifications.

Always disconnect the mains supply and close the main gas cock before working on the boiler.

Casing panels should only be removed for maintenance and servicing purposes.

Refit all panels on completion of maintenance or servicing before putting the boiler back into service.

Instruction and warning labels on the boiler must never be removed or covered and must be clearly legible throughout the entire service life of the boiler. Damaged or illegible instruction and warning labels must be replaced immediately.

Generally applicable safety instructions related to accident prevention must be consulted in addition to the information supplied in this technical documentation.

Boiler modifications and spare parts

The boiler must not be modified or non-Remeha spare parts fitted without the express written approval of Remeha.

Remeha Gas 310 ECO

2 GENERAL DESCRIPTION OF BOILER

The Remeha Gas 310 ECO boiler is a fully assembled, free standing, gas fired (Natural gas only), fully modulating high efficiency condensing boiler and is supplied plastic wrapped, crated on a pallet.

The sectional cast aluminium heat exchanger and other major components are contained within a rigid steel frame with removable casing parts for maintenance purposes. The Gas 310 ECO frame is fitted with a set of casters to enable the assembled unit to be easily manoeuvred into position within the plant room on site with the minimum of effort. All major electrical and electronic controls are contained within the instrument panel mounted on top of the boiler at the opposite end to the connections facing to the front (long side) but can be rotated 90° towards the short side to suit site location.

The boiler is available with flow and return connections on the left or right hand end of the boiler (THIS MUST BE DECIDED AT TIME OF ORDER), with the gas connection on the top of the boiler. The flue gas outlet c/w a condensate connection will be at low level on the same side as the connections. Combustion air inlet (for room sealed operation) is located at the top of the boiler. The front or "service side" of the boiler provides access to the heat exchanger inspection hatch and other service items, see *fig. 02 and fig. 04*.

The boiler is suitable for room sealed or open flue applications and has been designed for central heating and indirect hot water production at working pressures not exceeding 6 bar. It must be installed on a fully pumped system and is designed for operating pressures between 0.8 and 6 bar.

The pre-mix gas burner (NG only) with its gas/ air ratio control system ensures clean, trouble free operation with higher than average efficiencies of up to 109% Hi (NCV) in the condensing mode combined with ultra low NO_x and minimum CO emissions.

The standard control package allows for external On/ Off, High Low (volt free switch/s) or modulating control (0-10V input). The built in digital display shows normal operating/ fault code indication and allows actual and set values to be read and adjusted.

The intelligent, advanced boiler control ('abc[®]') continuously monitors the boiler operating conditions, varying the heat output to suit the system load. The control is able to react to external "negative" influences in the rest of the system (flow rates, air/ gas supply problems) maintaining boiler output for as long as possible without resorting to a lock out condition. At worst the boiler will reduce its output and/ or shut down (shut off mode) awaiting the "negative" conditions to return to normal before re-starting.

The 'abc[®]' control cannot override the standard flame safety controls.

All Gas 310 boilers are live fired after assembly to ensure the boiler and controls comply with our strict quality policy.

The unit has been inspected for compliance with the essential requirements of the following directives:

- Gas Appliances Directive, no. 90/ 396/ EEC
- Efficiency Directive, no. 92/ 42/ EEC
- EMC Directive, no. 89/ 336/ EEC
- Electrical Low Voltage Directive, no. 73/ 23/ EEC
- Pressure Equipment Directive, no. 97/ 23/ EEC, art. 3, item 3

CE identification number (PIN) : 0063BP3474

NO_x Class : 5

Type classification of flue

gas discharge : B23, C33, C43, C53,
C63, C83

3 DESIGN

3.1 Boiler version

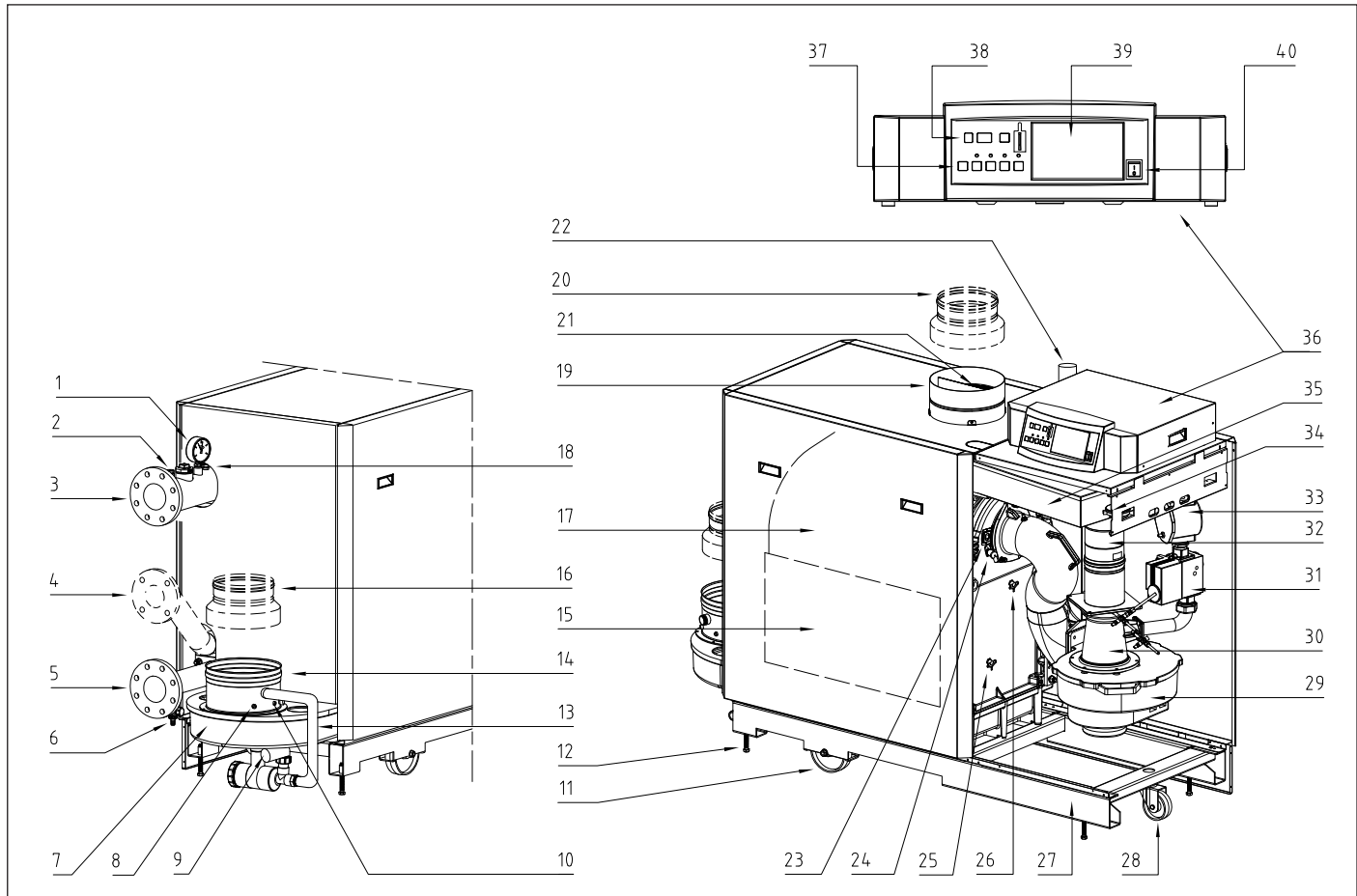

fig. 02 Cross-section Remeha Gas 310 ECO (Left hand boiler illustrated)

00.31H.79.00002

The service side of the boiler (with the heat exchanger inspection cover) is the front.

1. Pressure gauge
2. Pocket for external temperature sensor (7 mm i/d plain pocket)
3. Flow connection
4. 2nd Return connection (Optional)
5. Return connection
6. Filling/ drain cock
7. Condensate collector
8. Flue gas temperature sensor
9. Condensate drain
10. O₂/ CO₂ measuring point
11. Positioning wheels
12. Jacking bolts
13. Condensate drain hose
14. Flue gas discharge
15. Inspection hatch
16. Adapter Ø 250/ Ø 200 mm (optional)
17. Heat exchanger
18. Flow temperature sensor
19. Air supply

20. Adapter Ø 200/ Ø 250 (optional)
21. Air supply grille
22. Gas connection
23. Inspection glass
24. Ignition/ionisation electrode
25. Return temperature sensor
26. Boiler block temperature sensor
27. Frame
28. Steering castor
29. Fan
30. Venturi
31. Gas valve multiblock
32. Non return valve
33. Gas filter
34. Air pressure differential sensor (LDS)
35. Air box
36. Instrument panel
37. Control keys
38. Read-out window
39. Weather compensator installation (optional)
40. On/off switch

Remeha Gas 310 ECO

3.2 Operating principle

Combustion air is drawn into the inlet connection from the plant room (room ventilated version) or from outside via the eccentric flue system (room sealed) by an air supply fan.

On the inlet side of the fan is a specially designed chamber (venturi unit) which takes gas from the multi-block and mixes it in the correct proportions with the incoming air. This mixing system ensures that the correct gas/ air ratio is delivered to the pre-mix burner at all times.

Depending on demand (under the dictates of flow/return sensor and other external/internal control inputs) the 'abc[®]' system determines the required boiler output.

The 'abc[®]' control then varies the speed of the air supply fan which alters the volume of air being drawn into the venturi, this change in volume is measured using air pressure differential which directly controls the volume of gas also being delivered to the venturi. The resultant controlled mixture is delivered to the premix burner.

This mixture is initially ignited by the combined ignition/ionisation probe, which monitors the state of the flame. Should the flame be unstable or not ignite within the pre-set safety time cycle the controls will (after 5 attempts) shut the boiler down requiring manual intervention to reset the boiler. The digital display will indicate a flashing fault code confirming the reason for the failure.

The products of combustion in the form of hot flue gases are forced through the heat exchanger transferring their heat to the system water, (the flue gas temperature is reduced to approximately 5/ 8°C above the temperature of the system return water) then discharged via the condensate collector, to the flue gas outlet connection, to atmosphere.

Because of the low flue gas exit temperature there will be a vapour cloud formed at the flue gas terminal -this is not smoke-, simply water vapour formed during the combustion process.

If the flue gas temperature falls below dew point (55°C), water vapour (created during the combustion process) will begin to condense out in the boiler, transferring its latent heat into the system water, thereby increasing the output of the boiler without increasing the gas consumption.

Condensation formed within the boiler and flue system is discharged from the boiler to an external drain via the drain pan and siphon supplied.

The boiler can be supplied, as an option with a second (constant temperature) return connection. This additional connection enables the boiler to make full use of its condensing ability whilst accepting both fixed and variable temperature returns from the same system.

4 TECHNICAL DATA

4.1 Dimensions

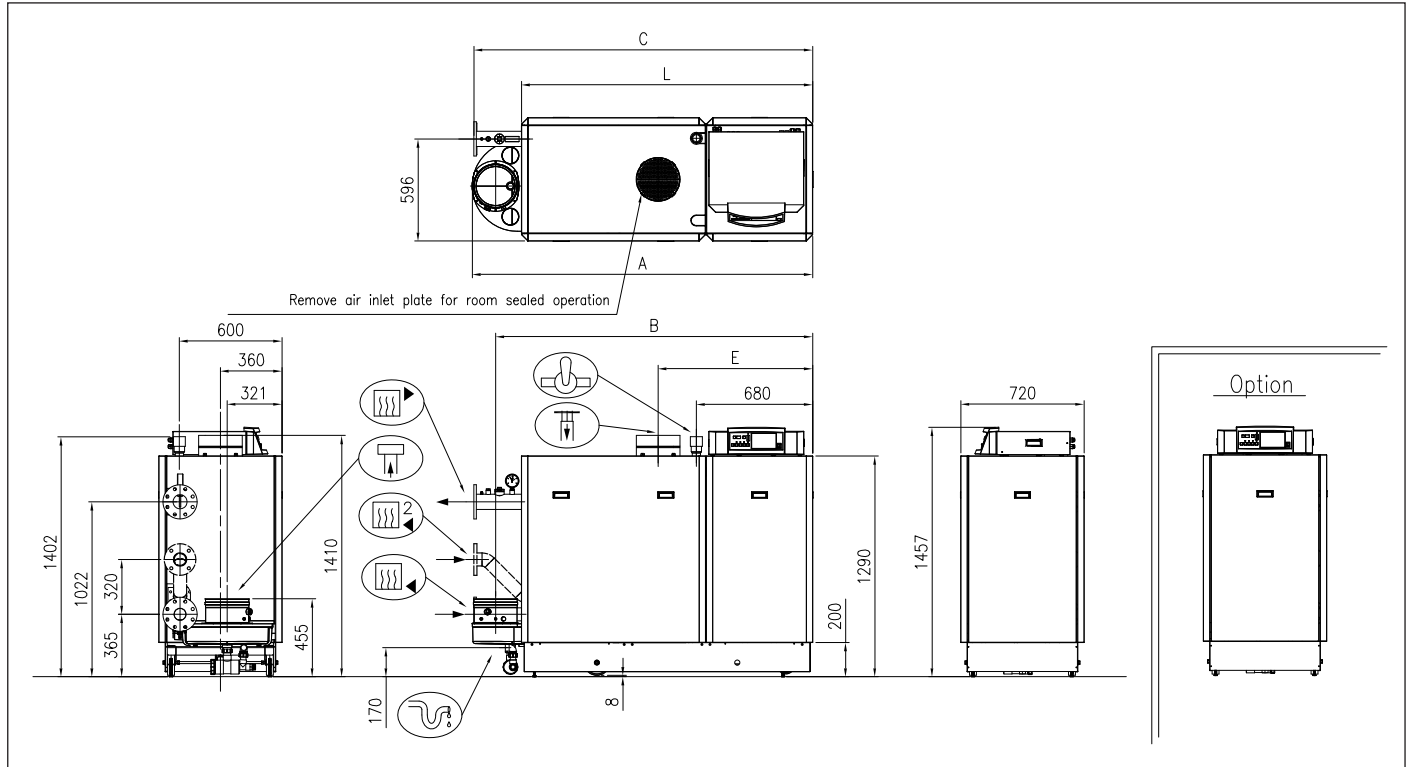









fig. 03 Elevation drawings (left-hand version shown)

04.31H.79.00002

-  Flow connection NW 80, DIN 2576
-  Return connection NW 65, DIN 2576
-  Gas connection 2" BSP (F)
-  Condensate drain 1 1/4" nb plastic waste
-  Flue gas discharge 250 mm i/d
-  Combustion air supply 250 mm i/d
-  Second return connection* (optional) NW 65, DIN 2576

* Second return water connection for highest return temperature level. Further information: please contact Broag Technical Dept.

Boiler type	A	B	C	E	L
5 sections	1600	1463	1590	1004	1312
6 sections	1600	1463	1590	901	1312
7 sections	1990	1853	1980	1110	1702
8 sections	1990	1853	1980	1007	1702
9 sections	1990	1853	1980	904	1702

table 01 Dimensions in mm

Remeha Gas 310 ECO

4.2 Technical data

Boiler type	Unit	Remeha Gas 310 ECO					
		5 sections	6 sections	7 sections	8 sections	9 sections	
General							
Boiler control options	-	Modulating, high/ low or on/ off					
Nominal output P _n (80/ 60°C)	min	kW	51	65	79	92	106
	max	kW	261	327	395	462	531
Nominal output P _n (50/ 30°C)	min	kW	56	71	84	98	113
	max	kW	282	353	427	499	573
Nominal input Q _n (GCV/ H _s)	min	kW	60	75	91	105	121
	max	kW	298	372	448	523	598
Nominal input Q _n (NCV/ H _i)	min	kW	54	68	82	95	109
	max	kW	269	336	404	471	539
Efficiency (H_i)							
Combustion (H _i) at 80/ 60°C	%	up to 99					
Heat to water (H _i) at 80/ 60°C	%	up to 98,5					
Standing losses (T _{average} = 45°C)	%	< 0.3					
Annual efficiency (H _i)	%	108,9					
Gas and flue gas side							
Gas category	-	Natural gas only					
Inlet pressure gas (boiler running)	min	mbar	17	17	17	17	17
	max	mbar	30	30	100	100	100
Gas consumption		m ₀ ³ / h	29	36	43	50	57
NO _x emission (annual emissions)		mg/ kWh	< 60				
NO _x emission (annual emissions, O ₂ = 0%, dry)		ppm	< 35				
Residual fan duty		Pa	150	150	150	150	150
Flue gas mass	min	kg/ h	91	114	138	160	183
	max	kg/ h	453	565	680	793	907
Flue gas temperature at 80/ 60°C	min	°C			57		
	max	°C			65		
Type classification due to discharging flue gasses	-	B23, C33, C43, C53, C63, C83					
Water side							
High limit temperature		°C	110				
Flow temperature	operating	°C	20 - 90				
Operating pressure	min	bar	0.8				
	max PMS	bar	6				
Water contents		litres	49	60	71	82	93
Water resistance at 11°C ΔT		mbar (kPa)	374 (37.4)	364 (36.4)	397 (39.7)	364 (36.4)	413 (41.3)
Water resistance at 20°C ΔT		mbar (kPa)	113 (11.3)	110 (11)	120 (12)	110 (11)	125 (12.5)
Electrical							
Mains supply		V/Hz	230/ 50				
Power consumption	min	Watt	12	12	12	12	12
	max	Watt	303	340	470	600	858

Insulation class	IP	20				
Other						
Weight dry	kg	360	410	460	510	560
Floor area	m ²	1.2	1.2	1.4	1.4	1.4
Noise level at a distance of 1 m from the boiler (average)	dB(A)	60				
Colour of casing	RAL	2002 (red); 9023 (grey)				

table 02 Technical data Remeha Gas 310 ECO

4.3 Quotation specification

- **Cast aluminium - sectional pre-mix gas fired fully condensing, modulating floor standing boiler**
- Sectional heat exchanger manufactured from cast aluminium
- Maximum operating pressure of 6 bar
- Maximum operating temperature of 90°C
- Ultra low NO_x (max. 35 ppm at 0% O₂)
- Pre-mix, fully modulating (20-100%) gas burner with unique gas/ air ratio control for maximum efficiency
- Intelligent advanced boiler control 'abc[®]' c/w a comprehensive operating, service and fault diagnostic facility
- No minimum flow requirement (see section 7.4.5)
- Available as conventional flue or room sealed operation
- Capable of remote BMS control (0 -10V modulating, on/ off or high/ low option)
- Socket for advanced service diagnostics (for PC/ PDA connection)
- Supplied fully factory assembled and tested
- Powder coated enamel steel casing BS; RAL colour: 2002 (red); 9023 (grey)

- Rigid steel box frame
- Suitable for use with Natural gas only
- Supplied as standard with on/ off switch, temperature indication, flow, return, heat exchanger block and flue gas sensors
- Supplied as standard with indicating module No. 1 lock-out indication (Volt free), shut down indication (Volt free), boiler on indication (24 Volt AC)
- Efficiencies up to 109% (NCV/ Hi)
- Manufactured to ISO 9001
- CE approved

4.4 Delivery options

Available in 5 section sizes, in "left-hand" or "right-hand" versions each with 2 instrument panel positions:

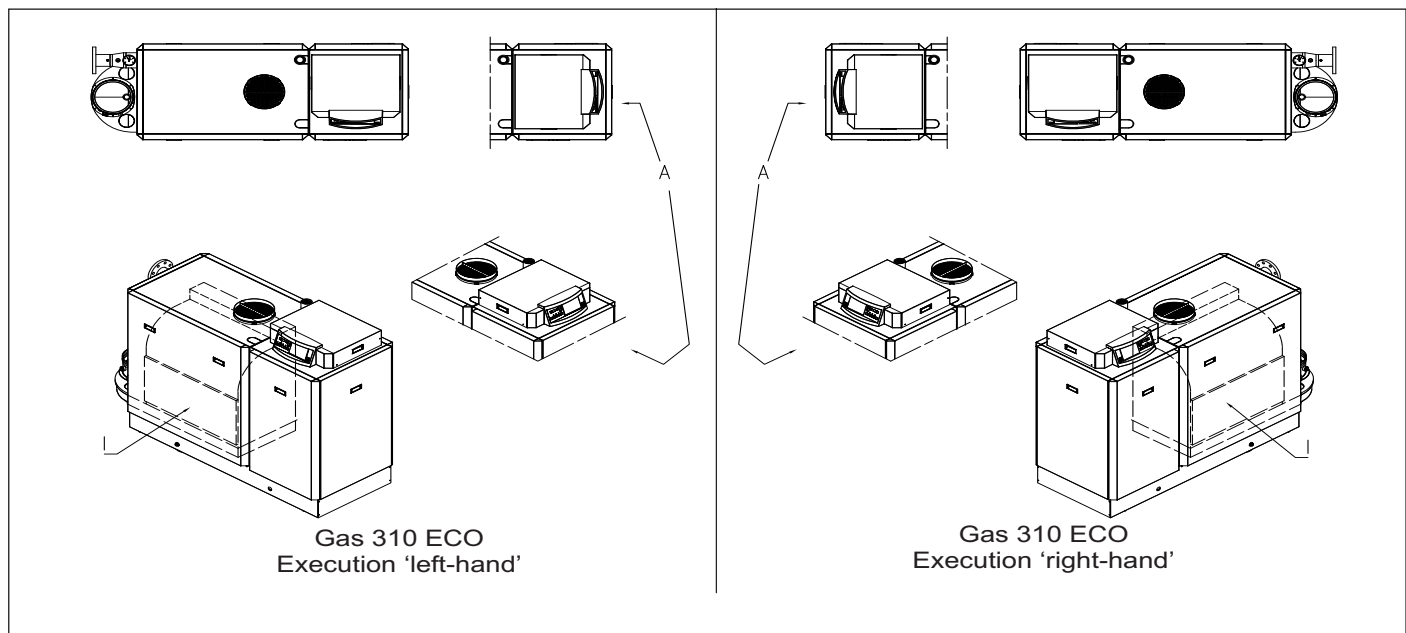

fig. 04 Installation options

04.31H.79.00004

I = Front (service side)

A = Short side (alternative orientation of the instrument panel)

Remeha Gas 310 ECO

The service side with the inspection cover on the heat exchanger is considered to be the front of the boiler. With a “left-hand” version, the flow, return and flue connections are on the left of the boiler as you face the front (service side). On a “right-hand” version, the flow, return and flue connections are on the right of the boiler as you face the front (service side). The boiler instrument panel can be rotated to face the front or the short side of the boiler (front will be standard unless stated on the purchase order) (see *fig. 04*).

! Important!! When ordering a Remeha Gas 310 ECO, it is essential that the number of sections and whether a “left-hand” or “right-hand” connection version is required as well as the orientation of the instrument panel (short or front side). The boiler comes entirely assembled and tested and will include, as far as possible, all accessories ordered.

4.5 Accessories

- Modulating “*OpenTherm*” weather compensators, “*Open Therm*” for single or *rematic*® for multi boiler configurations
- Second return connection
- System pressure sensor
- Flue adapter 250 mm to 200 mm i/d (stainless steel)
- Air supply adapter 250 mm to 200 mm i/d (stainless steel)
- Vertical room sealed terminal VRS 200/300 or VRS 250/350
- Condensate neutralisation box
- Condensate neutralisation granules
- Recom communication set with CD-ROM, interface and wiring
- Interfaces for communication with various controllers (see *section 8.6*)
- Gas leak proving control
- Minimum gas pressure switch
- Automatic flue gas damper for pressurised flue system
- Cleaning tools

5 EFFICIENCY INFORMATION

5.1 Annual efficiency

Up to 108.9% at Hi (up to 97% at Hs) at an average water temperature of 40°C (50/ 30°C).

5.2 Heat to water efficiency

- Up to 98.5% at Hi (88% at Hs) at an average water temperature of 70°C (80/ 60°C).
- Up to 106.4% at Hi (98% at Hs) at an average water temperature of 40°C (50/ 30°C).

5.3 Standing losses

Less than 0.3% at Hi (0.33% at Hs) at an average water temperature of 45°C

Note: NCV = Hi, GCV = Hs

6 APPLICATION DATA

The Gas 310 ECO can be used on all new and refurbishment projects in both single and multiple configurations. Conventional and room sealed flue system capability means that the boiler can be sited almost anywhere within a building. The Remeha *rematic*® and “*OpenTherm*” weather compensators (option) are able to communicate directly with

the boiler/s controls to make full use of their fully modulating features, ensuring that the boiler closely matches the system demand at all times. External control systems (BMS) can be interfaced with the boiler to provide on/ off - high/ low or modulating (0 -10V) control options.

7 INSTALLATION INSTRUCTIONS FOR HEATING INSTALLER

7.1 General

All gas appliances must, by law, be installed by competent persons (e.g. Corgi registered). Failure to install appliances correctly could lead to prosecution. It is in your own interest and that of safety to ensure that the law is complied with.

The following instructions must be adhered to when the Remeha Gas 310 ECO is installed:

- Gas Safety (Installation and Use) Regulations 1984 (as amended).

In addition to the above regulations, this boiler must be installed in compliance with:

- Current I.E.E. Regulations for electrical installations
- Local building regulations
- The Building Standards (Scotland)
- (Consolidation) Regulations
- By-laws of the local water undertaking
- Health and Safety Document No 635 'The Electricity at Work Regulations 1989'

It should also be in accordance with the relevant recommendations in the current edition of the following British Standards and Codes of Practice, viz. BS 6644, BS5978 Part 1 & 2, BS 5449, BS 5446, BS 6798, BS 6891 and BG DM2.

Important:

The Remeha Gas 310 ECO is a CE certified boiler and must not be modified or installed in any way contrary to these "Installation and Maintenance Instructions". Manufacturers Instructions must NOT be taken as over-riding statutory obligations.

7.2 Delivery and installation

The Remeha Gas 310 ECO is supplied fully assembled plastic wrapped and packed in a crate on a pallet. The overall dimensions of the crate are 80 cm wide and 175 cm high with the length dependant on the number of sections (5 & 6 sections: 170 cm, 7 to 9 sections: 209 cm). The base of the packaging is a 76-cm wide pallet to enable it to be transported with a pallet truck, forklift truck or 4-wheel transport boards.

Excluding the crate the boiler is 72-cm wide c/w casing panels and 70 cm without casing and will fit through most standard doors (minimum door opening width 80 cm). The boiler itself has wheels so that, once the packaging has been removed, it can easily be moved around on a smooth surface. The packaging lid includes a rocking ramp, which can be used to negotiate obstacles

such as doorsteps and small plinths. Once in position the boiler is fixed into position using the fitted jacking bolts which both raise the wheels of the ground and level the boiler. Technical documentation is supplied with the boiler in a holder on the inside of the boiler casing (beneath the instrument panel). A number of small loose components, such as the 4 support pads and the syphon for the boiler have been placed in the flue gas discharge.

It is advisable (preferable) to install the Remeha Gas 310 ECO as follows:

- Place the crate c/w the boiler in the boiler room. Make sure there is enough room at one end of the crate for the boiler and ramp and clearance for the crate to be removed (at least 3 M).

- ! Important!!** Always transport the boiler in the protective packaging wherever possible.
- Remove fixing strips, packaging lid and all other packaging leaving the boiler on the pallet.
 - Place the packaging lid on the end of the pallet (creating a ramp - secure with screw).
 - Roll the boiler on its wheels off the pallet down the ramp to the boiler room floor.

- ! WARNING!** Use retaining straps to control the rate of travel - Do not stand in front of the boiler!
- Manoeuvre the boiler to required final position.

 The pallet lid can be used as a rocking ramp to convey the boiler over obstacles, such as thresholds etc.

- ! Important!!** The wheels are designed for transport purposes only and MUST NOT be used when the boiler is in its final position!
- Place the 4 support pads under the adjustment bolts.
 - Use the adjusting bolts to jack up the boiler lifting it clear of the wheels and with the top of the condensate collector level.
 - Fit the syphon assembly.
- Use the plastic packaging to protect the boiler until required for use.

- ! Important!!** Additional protection may be required if site conditions warrant it – overhead builders working, insulation etc.

Remeha Gas 310 ECO

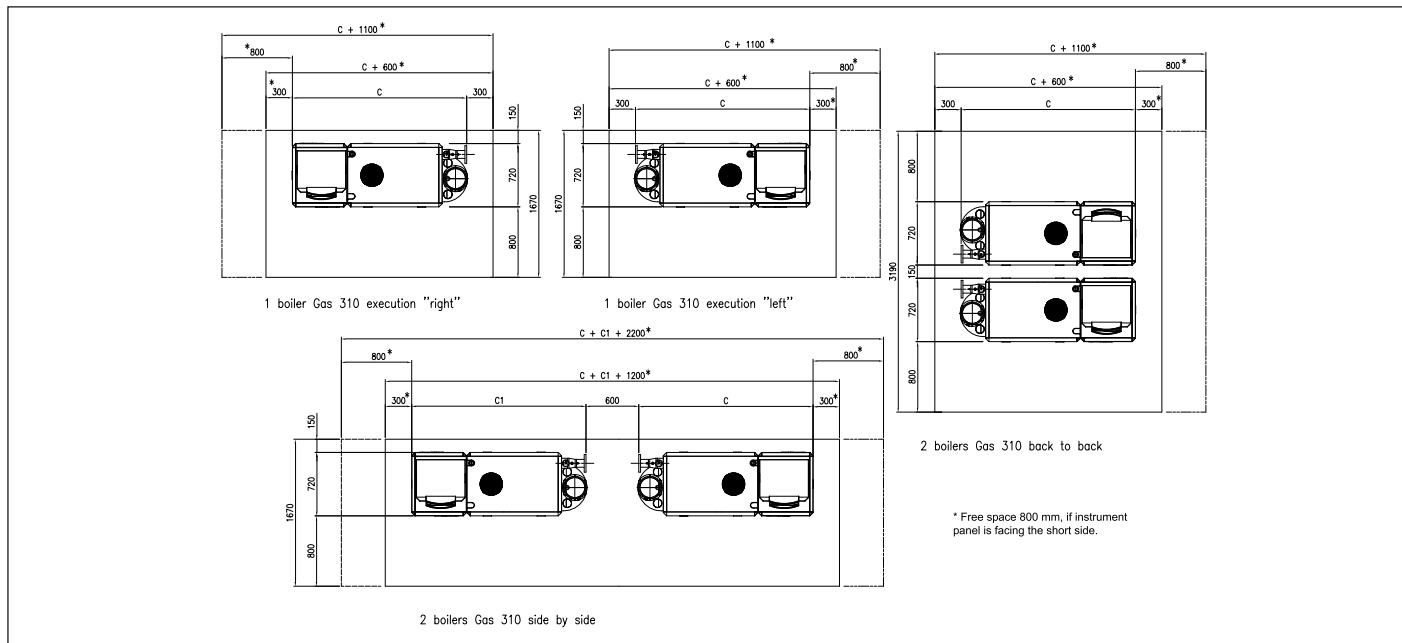

fig. 05 Layout in the boiler room

04.31H.79.00005

Number of sections	C in mm
5	1590
6	1590
7	1980
8	1980
9	1980

Number of sections	C in mm	D in mm
5	1590	1118
6	1590	1118
7	1980	1508
8	1980	1508
9	1980	1508

table 03 Base dimensions

Clearance of at least 800 mm is required at the front (service side) of the boiler. However, we recommend a clearance of 1 m. A clearance of at least 400 mm above the boiler and at least 300 mm on both ends (800 mm if the instrument panel is rotated to face the short end). An isolating gas main cock must be installed near the boiler, within hand's reach.

fig. 06 shows the boiler's support area including the position of the support pads (shaded boxes) supplied.

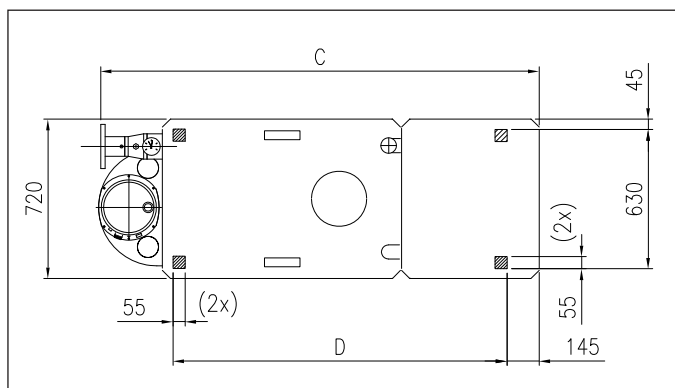

fig. 06 Support area Remeha Gas 310 ECO

00.31H.79.00005

7.3 Flue gas discharge and air supply

7.3.1 General

The Remeha Gas 310 ECO is suitable for both conventional room ventilated or eccentric room sealed operation.

Room sealed terminals should comply with the Gastec QA-requirements for vertical outlet constructions.

Any horizontal pipework in the flue gas discharge system should slope towards the boiler.

Horizontal pipework in the air supply system should slope towards the supply opening and may require a drain point at the low point.

Care should be taken when siting flue exit positions as a vapour plume will be visible when the boiler is operational (flue gas temperature will be less than $< 77^{\circ}\text{C}$ resulting in the water vapour condensing out on contact with the air).

7.3.2 Classification due to discharging flue gases

Classification according to CE:

Type B23: Conventional room ventilated appliance without draft diverter. Air supply from boiler room; flue gas discharge on roof.

Type C33: Room sealed appliance, connected to combined roof outlet.

Type C43: Room sealed appliance in cascade configuration, connected via two ducts to a common duct system serving more than one appliance.

Type C53: Room sealed appliance, connected to separate ducts for the air supply and flue gas discharge, terminated in zones of different pressure.

Type C63: Room sealed appliance, supplied without the terminal or the air supply and flue gas discharge ducts.

Type C83: Boiler with room sealed operation, connected to separate air supply and flue gas discharge duct, with flue gas discharge duct always in depression.

Conventional flue or room ventilated installations:

A room-ventilated boiler takes the required combustion air from the plant room. Combustion air for the boiler must be provided to the room/ compartment in accordance with BS 6644. A table showing the maximum discharge lengths for the room ventilated version of the Remeha Gas 310 ECO can be found in *section 7.3.6*.

Room sealed installations:

It is unnecessary to provide separate combustion air to the room/compartment as this is supplied direct to the boiler via the eccentric flue and air inlet system to the vertical terminal unit (see *fig. 09*, VRS 200/250 options available from Broag).

Additional ventilation will be required to the room/compartment in accordance with BS 6644 (compartment ventilation).

For installations where supply and discharge points are in two different pressure zones CLV system please contact Broag Technical Dept. for further details and advice.

Note: The boilers can also be installed on a flue dilution system, but must incorporate a total flue break to avoid boiler gas/air ratio controls being affected by the flue dilution fan pressures. For full details please contact Broag.

A table showing maximum air supply/ flue gas discharge lengths for the room sealed version of the Remeha Gas 310 ECO can be found in *section 7.3.7*.

7.3.3 Connection options

The Remeha Gas 310 ECO is available in a room ventilated and a room sealed version. If the room-sealed version is used, the grille must be removed before installing the air supply pipe.

7.3.4 Inlets/Outlets

For conventional flue systems the flue terminal exit point should discharge vertically and be c/w a tapered cone and bird guard. For room sealed options use the Broag VRS 200/250 vertical terminal.

7.3.5 Other requirements

Flue gas discharge materials:

Single wall, rigid: stainless steel, thick-walled aluminium (to comply with building regulations).

Flexible: stainless steel (to comply with building regulations).

Flue gas discharge structure:

The flue gas discharge pipe must have airtight and watertight joints and connections and should be seamless. Horizontal sections in the flue gas discharge pipe must slope down towards the boiler (at least 5-cm per meter).

Flue liners:

If flue liners are used they must be manufactured from stainless steel or flexible plastic (continuous temperature rating of 120°C) and be gas and water tight.

Air supply materials:

Single wall, rigid or flexible: aluminium, stainless steel.

Air supply structure:

The air supply pipe must also be airtight. Horizontal sections in the air supply must slope away from the boiler towards the supply opening and incorporate a drain connection if the route rises from a lower point that could flood.

7.3.6 Single boiler conventional flue

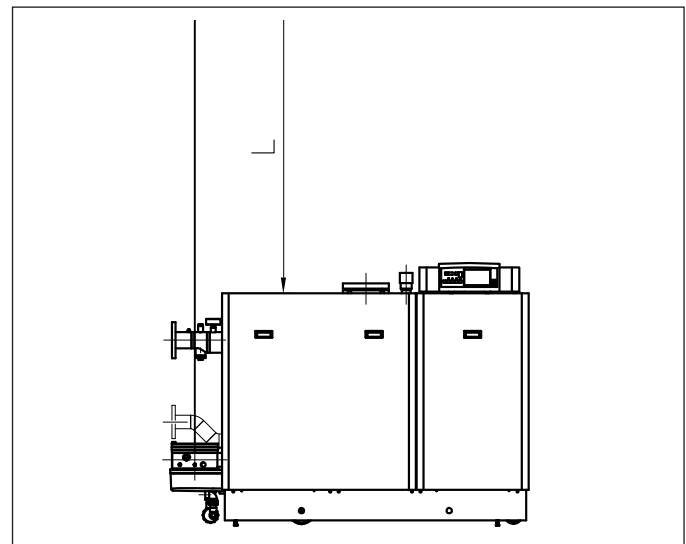

fig. 07 Flue gas discharge duct without bends, single boiler, conventional flue.

00.31H.79.00011 (afb 1)

Remeha Gas 310 ECO

Flue diameter		200 mm *	250 mm			
Model Gas 310 ECO		sections				
		5	6	7	8	9
max eq. length L	m	103	65	145	105	78
eq. length bend 45°, R=D	m	1.6		2		
eq. length bend 90°, R=D	m	2.8		3.5		

table 04 Calculation data conventional flue

* When flue gas discharge pipes with a diameter of 200 mm are used, an optional adapter is required for connection to the Remeha Gas 310 ECO from Ø 250 - Ø 200 mm.

Example: Gas 310 ECO, 6 sections, total length 27 m, diameter 200 mm, 2 bends 90°. $27\text{ m} + 2 \times 2.8 = 32.6 < 65\text{ m} \rightarrow$ flue OK.

Note: If the design parameters are outside the values shown in the above table or there is any doubt over the flue system, please contact our technical department for calculation to be undertaken.

7.3.7 Single boiler, room sealed flue

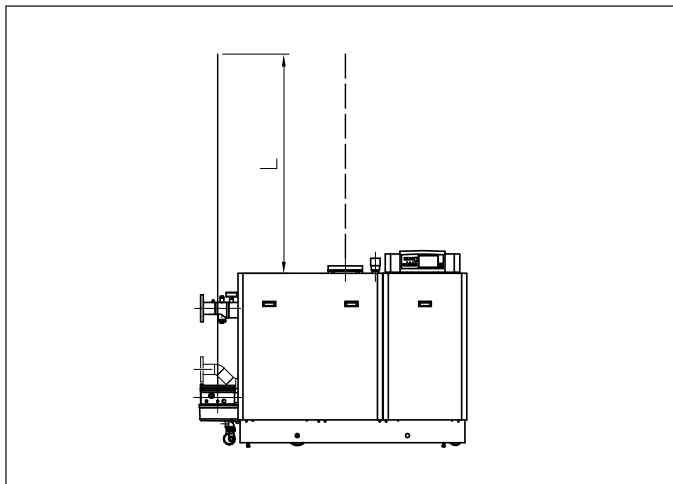

fig. 08 Flue gas discharge duct without bends, single boiler, room sealed application.

00.31H.79.00011 (nr 6)

Flue/ air inlet diameter		250/ 250 mm				
Model Gas 310 ECO		sections				
		5	6	7	8	9
max eq. length L	m	172	108	71	49	34
eq. length bend 45°, R=D	m	2				
eq. length bend 90°, R=D	m	3.5				

table 05 Calculation data room sealed applications

Example:

Gas 310 ECO, 8 sections, total length flue and air inlet each 32 m, each 2 bends 90°. $32\text{ m} + 2 \times 3.5 = 39.0 < 49\text{ m}$; flue and air inlet OK.

Note: If the design parameters are outside the values shown in the above table or there is any doubt over the flue system, please contact our technical department for calculation to be undertaken.

Combined vertical terminal sets, and roof sealing plates for flat roofs, are available for the room-sealed version with diameters of Ø 200 and Ø 250 in accordance with fig. 09.

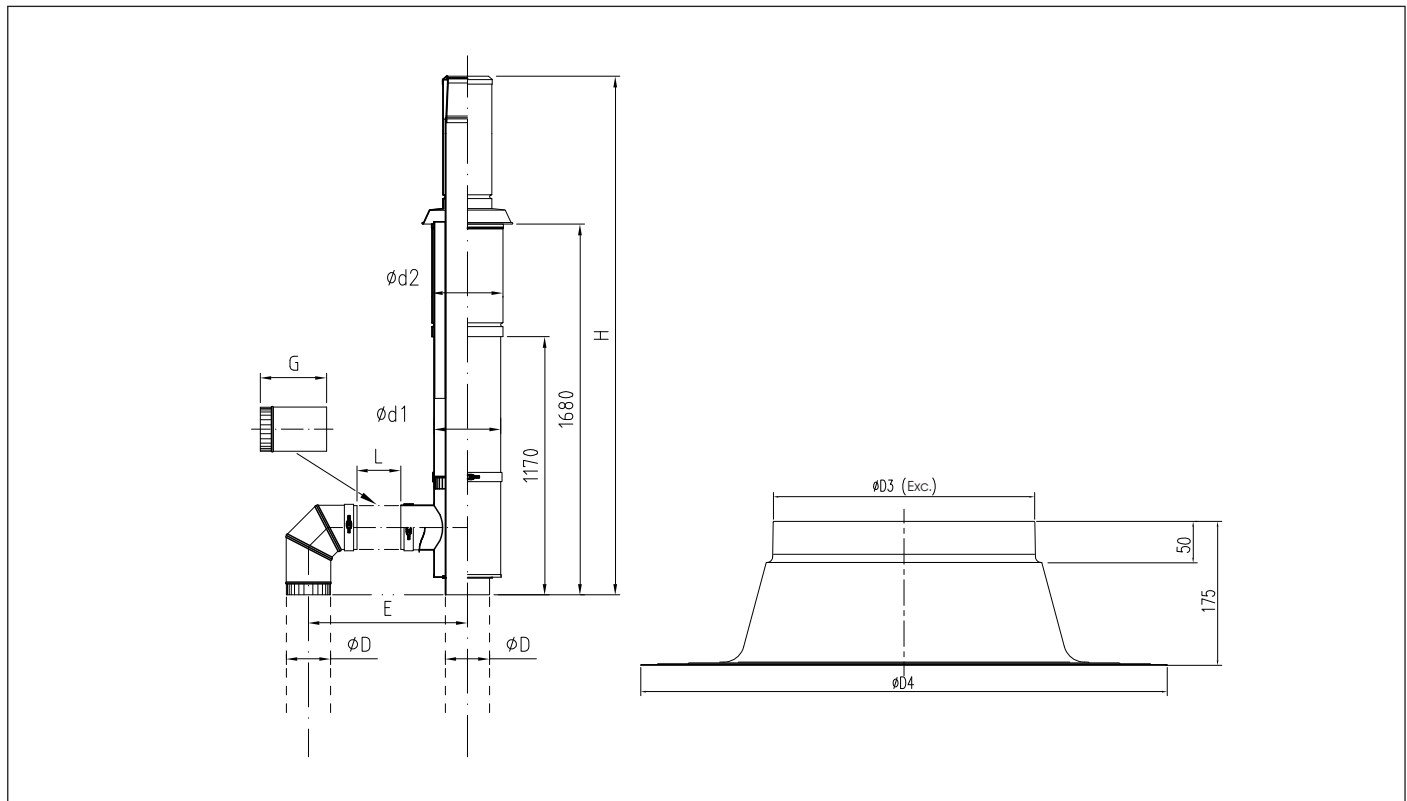

fig. 09 Vertical terminal for room sealed operation
pdf

Number of sections	ØD	E	H	L	G	Ød1	Ød2	ØD3 ext.	ØD4 int.
	mm	mm	mm	mm	mm	mm	mm	mm	mm
5	200	459	2350	nvt	nvt	300	320	318	640
	250	459	2500	nvt	nvt	350	370	368	690
6	200	562	2350	42	142	300	320	318	640
	250	562	2500	2	102	350	370	368	690
7	200	743	2350	223	323	300	320	318	640
	250	743	2500	183	283	350	370	368	690
8	200	846	2350	326	426	300	320	318	640
	250	846	2500	286	386	350	370	368	690
9	200	949	2350	429	529	300	320	318	640
	250	949	2500	389	489	350	370	368	690

table 06 Dimensions vertical terminal in mm

Remeha Gas 310 ECO

7.3.8 Different pressure zones

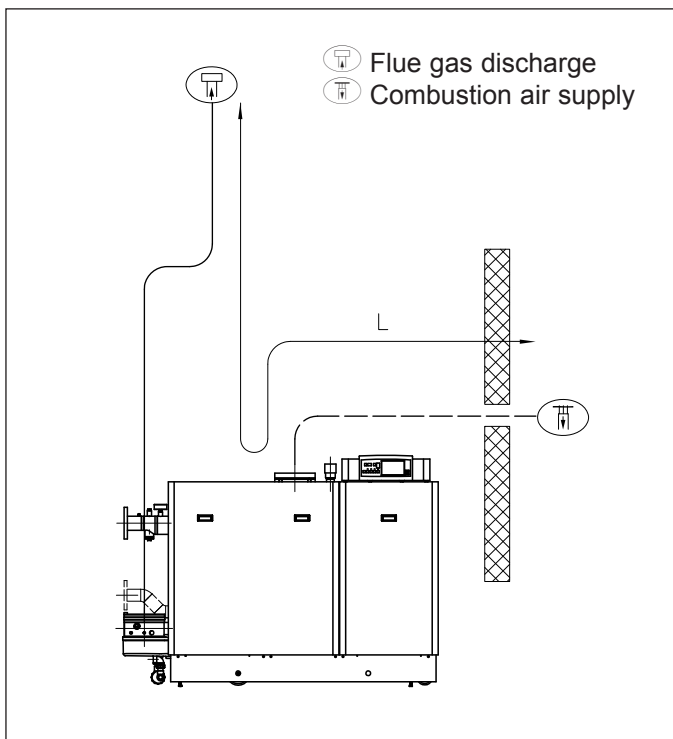

fig. 10 Different pressure zones

00.31H.79.00012

The Remeha Gas 310 ECO boilers are capable of operating with the air inlet and flue outlet in different pressure zones (CLV System).

The max height difference between air inlet and flue gas outlet is 36 meters and the maximum total length of air inlet and flue gas outlet pipe work L is shown in table 07.

Flue/ air inlet diameter		250/ 250 mm				
Model Gas 310 ECO		sections				
		5	6	7	8	9
maximum total length of air inlet and flue gas outlet pipework L	m	262				
		158				
		98				
		62				
		40				
bend 45°, R=D	m	2				
bend 90°, R=D	m	3.5				

table 07 Different pressure zones

Note: this system may not be used in areas with adverse wind conditions (i.e. in some coastal regions).
Note: If the design parameters are outside the values shown in the above table or there is any doubt over the flue system, please contact our technical department for calculation to be undertaken.

7.3.9 Header flue systems

For multiple boiler installations with common flue systems please refer to Broag for advice.

7.4 Installation details

7.4.1 Water pressure

The individual boiler sections are each subjected to a test pressure of 10 bar. On assembly the complete block is subjected to a factory pressure test using compressed air at 2 bar for 1 minute.

The boiler is suitable for a maximum working pressure of 6 bar.

7.4.2 Condensate discharge

Discharge the condensate via a tundish, directly into a drain. Only use synthetic material for the connecting pipework because of the acidity (pH 2 - 5) and allow a min. of 30 mm per meter fall to ensure a good flow rate. Fill the siphon with clean water before firing the boiler. It is not advisable to discharge into an outside gutter, because of the risk of freezing.

7.4.3 Water treatment

The system should be filled with mains cold water (for the UK this will usually have a pH of between 7 and 8). Pressurised installations with a boiler/ system content ratio of 1:10 or less should not require water treatment, provided that the following conditions apply:

1. The system is flushed thoroughly to remove all fluxes and debris and filled completely once.
2. Make up water is limited to 5% per annum.
3. The hardness of the water does not exceed 360 ppm (20°D).

All scale deposits will reduce the efficiency of the boiler and should be prevented. However provided the above is complied with any scale produced will not be too detrimental to the boiler efficiency and will not reduce the anticipated life expectancy of the boiler.

NOTE: Scale deposits in excess of 5 mm will reduce boiler efficiency and increase the risk of premature casting failure.

As most systems contain a variety of metals it is considered good practice to provide some form of water treatment (especially in open vented systems) in order to prevent or reduce the following.

- Metallic corrosion
- Formation of scale and sludge
- Microbiological contamination
- Chemical changes in the untreated system water

Suitable chemicals and their use should be discussed with a specialist water treatment company prior to carrying out any work. The specification of the system and

manufacturers recommendations must be taken into account, along with the age and condition of the system. New systems should be flushed thoroughly to remove all traces of flux, debris, grease and metal swarf generated during installation. Care to be taken with old systems to ensure any black metallic iron oxide sludge and other corrosive residues are removed, again by thoroughly flushing, ensuring that the system is drained completely from all low points.

NOTE: Please ensure that the new boiler plant is not in circuit when the flushing takes place, especially if cleansing chemicals are used to assist the process.

Under no circumstances is the boiler to be operated with cleaning chemicals in the system.

To summarise:

- Minimise water loss
- Prevent pumping over in open vented systems
- Provide adequate air venting at all high points
- Maximum chlorine content of 200 mg/ l

Take advice on the suitability of inhibitors for use with aluminium boilers

MAX pH of 8.5 when using additives (max. pH of 9 without additives).

If water treatment is used, we recommend the following products:

'Copal' manufactured by:

Fernox Manufacturing Company Ltd.
Britannia Works
Clavering
Essex, CB1L 4QZ
Tel No: 0179 955 0811
Fax No: 0179 955 0853

or:

Sentinal 'X100' manufactured by:

BetzDearborn Ltd
Sentinal
Foundry Lane
Widnes
Cheshire WA8 8UD
Tel No: 0151 424 5351
Fax No: 0151 420 5447

For the correct dosage and for further information on water treatment or system cleaning we advise direct contact with either of the above companies.

7.4.4 Safety valve

A safety valve should be fitted in accordance with BS 6644. The flow pipe on the Remeha Gas 310 ECO includes a fitting, which can be used for a safety valve; size 1½" BSP (F).

7.4.5 Water circulation

Provided that the factory pre-set high limit and flow temperatures are not altered and the Remeha modulating controls are used no minimum flow rate is required as the 'abc'® system will monitor these conditions and reduce the boiler output, finally shutting down until flow conditions improve. As a result, the boiler is virtually unaffected by low water flow.

7.4.6 Thermostat pocket

A thermostat pocket (7 mm i/d plain pocket) is supplied as standard in the flow pipe for an external control/ BMS temperature sensor.

7.4.7 Noise production

The average noise level measured at 1-m distance around the boiler is < 60 dBA at full output, avoiding the need for additional acoustic measures.

7.5 Multiple boiler installation

The Remeha Gas 310 ECO can be installed individually or in a multiple boiler installation. The narrow width and depth of the boiler and its ability to be mounted closely together provides a high output within a small floor area (see fig. 05)

We recommend that boilers that are not in service are disconnected from the water supply by means of throttle valves or non-return valves.

A "DUO" version the Gas 610 (6 to 9 section only) will also be as a dual cascade unit.

Advice and schematic drawings are available on request, contact Broag Technical Dept.

Remeha Gas 310 ECO

1. **OpenTherm or rematic®** modulating cascade controller
2. boiler pump
3. safety valve
4. non return valve
6. isolating valve
7. automatic air vent
8. low loss header
9. drain cock
10. system pump
11. expansion vessel system
12. flow temperature sensor
13. outside temperature sensor

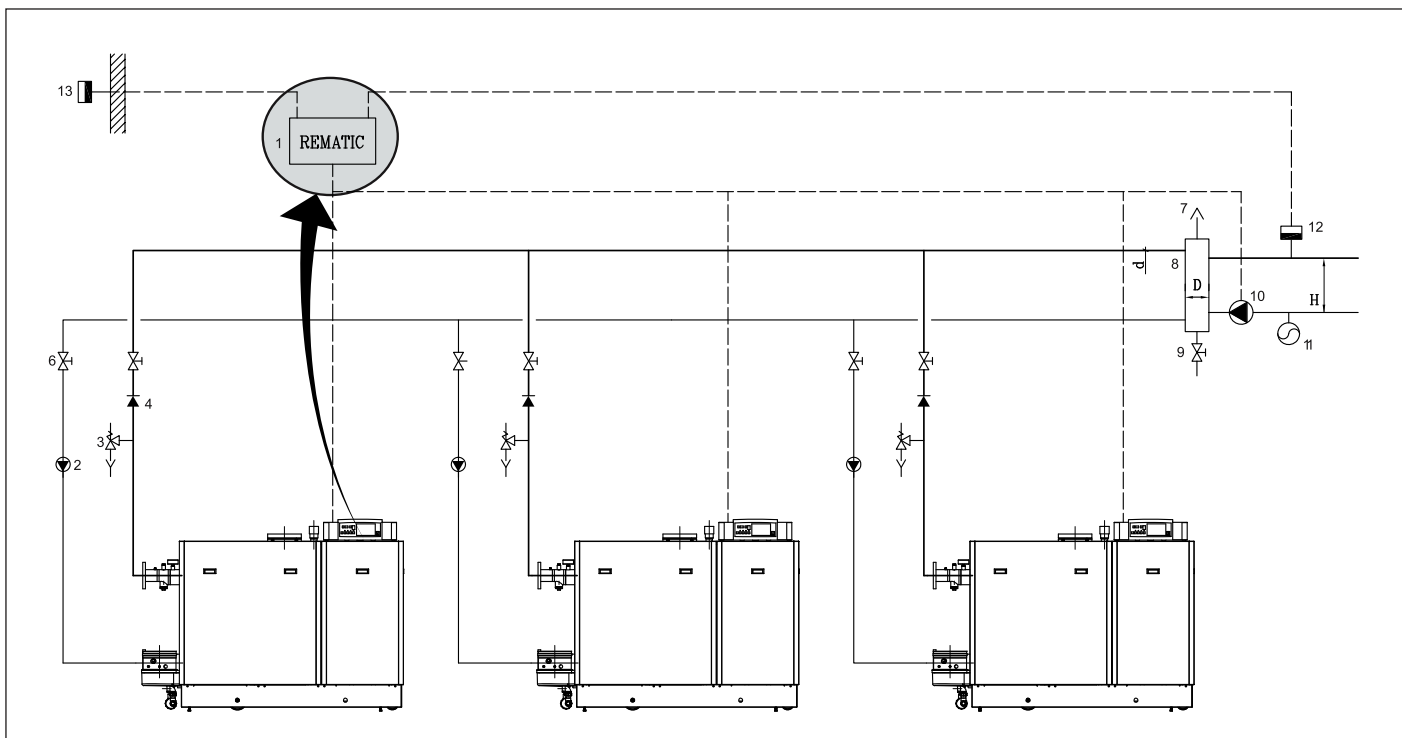

fig. 11 Example hydraulic diagram cascade configuration

pdf

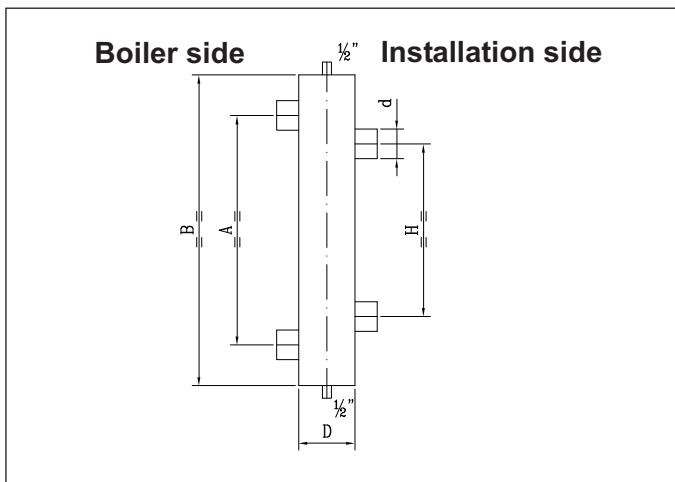

fig. 12 Low loss header > 500kW

00.W20.79.00040

The minimal dimensions of low loss header and various pipes, based on a ΔT of 20°C are represented in *table 08*

The minimal dimensions of low loss header and various pipes, based on a ΔT of 11°C are represented in *table 09*.

The low loss header has to be sized for the maximal flow Q required. The Remeha Gas 310 ECO has no built-in pump.

Output up to	Flow Q	D \varnothing		D square	d interior		H	A	B
		inch	DN		mm	inch			
KW	m³/h	inch	DN	mm	inch	DN	mm	mm	Mm
550	23,65	8	200	190	2 ½	65	614	818	983
625	26,88	10	250	200	2 ½	65	654	872	1041
875	37,63	10	250	230	3	80	774	1032	1213
1250	53,75	12	300	280	4	100	925	1233	1431
1500	64,50	14	350	300	4	100	1013	1351	1558
1550	66,65	14	350	310	5	125	1030	1373	1582
2000	86,00	16	400	350	5	125	1170	1560	1783
2275	97,83	18	450	370	5	125	1248	1664	1895
2500	107,50	18	450	390	6	150	1308	1744	1982
2650	113,95	20	500	400	6	150	1347	1796	2038

table 08 Dimensions low loss header, based on a ΔT of 20°C

Output up to	Flow Q	D \varnothing		D square	d interior		H	A	B
		inch	DN		mm	Inch			
KW	m³/h	inch	DN	mm	Inch	DN	mm	mm	Mm
675	52,77	12	300	280	4	100	916	1222	1419
825	64,50	14	350	300	4	100	1013	1351	1558
1100	86,00	16	400	350	5	125	1170	1560	1783
1250	97,73	18	450	370	5	125	1247	1663	1894
1375	107,50	18	450	390	6	150	1308	1744	1982
1825	142,68	20	500	450	6	150	1507	2009	2268
1900	148,55	20	-	460	8	200	1538	2050	2312
2100	164,18	21	-	480	8	200	1616	2155	2426
2300	179,82	22	-	500	8	200	1692	2256	2534
2500	195,46	23	-	530	8	200	1764	2352	2638
2650	207,18	24	-	540	8	200	1816	2421	2713

table 09 Dimensions low loss header, based on a ΔT of 11°C

Remeha Gas 310 ECO

8 INSTALLATION INSTRUCTIONS FOR ELECTRICAL INSTALLER

8.1 General

The Remeha Gas 310 ECO is supplied as standard with electronic operating and flame ionisation safety controls with a specially designed microprocessor at the heart of the system.

The boiler is pre-wired as shown in the wiring diagram in *fig. 18*. All external connections can be made on the terminal strips (one low voltage 24V AC and one mains voltage 230V AC).

Each boiler must be installed with its own two pole isolating switch in the mains supply rated at 10 amps.

8.2 Electrical specifications

8.2.1 Mains voltage

Each boiler requires a 230v – 1 – 50 Hz supply rated at 10 amps with phase/ neutral/ earth. The boiler is sensitive to phase/neutral and therefore has a facility to ensure that phase and neutral are correctly connected. If phase and neutral are crossed, the display will flash  alternately.

8.2.2 Control unit

Manufacturer : Honeywell
Type : MCBA 1458 D
Mains voltage : 230 V/50 Hz
Safety time : 3 sec.

Each Remeha Gas 310 ECO has a unique “boiler code”. These codes, together with other data as boiler type, counter data, etc., are stored in a “code-key” that belongs to the boiler. If the control unit is replaced this information remains stored in the code-key.

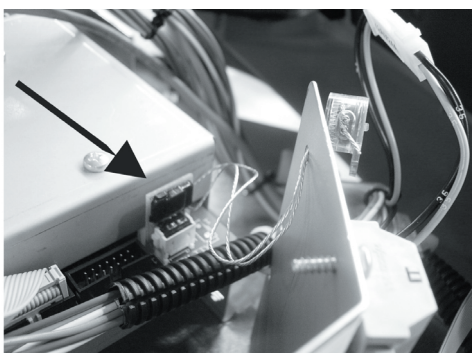

fig. 13 Position code-key

8.2.3 Power consumption

Power consumption at stand-by /part load /full load:

- 5 sections: 12 Watt / 53 Watt / 303 Watt
- 6 sections: 12 Watt / 56 Watt / 340 Watt
- 7 sections: 12 Watt / 77 Watt / 470 Watt
- 8 sections: 12 Watt / 77 Watt / 600 Watt
- 9 sections: 12 Watt / 80 Watt / 858 Watt

Max boiler module start current 4 amps excluding a “system pump” if connected to terminal block X27 connections 9 and 10.

8.2.4 Fuse ratings

The circuit board on the control unit contains the following fuses:

- F1 - 2 AF mains voltage fuse (automatic fuse)
- F2 - 2 AT for gas valve multiblock
- F3 - 2 AT for 24 V circuit
- F10 - 2 AT for shunt pump
- F11 - 1 AT for flue gas damper
- F12 - 1 AT for butterfly valve
- F13 - 2 AT for heating pump
- F14 - 1 AT for external gas valve

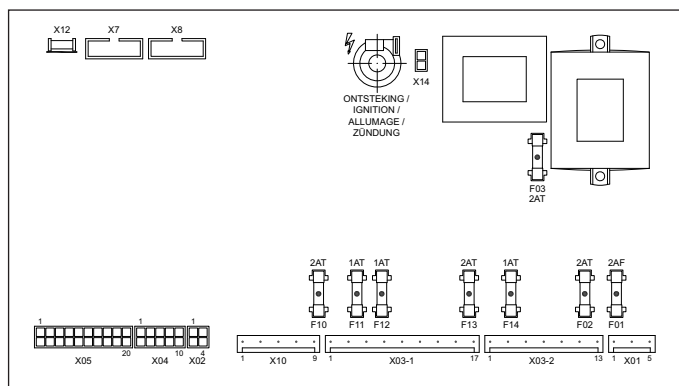

fig. 14 Control unit

00.31H.79.00009

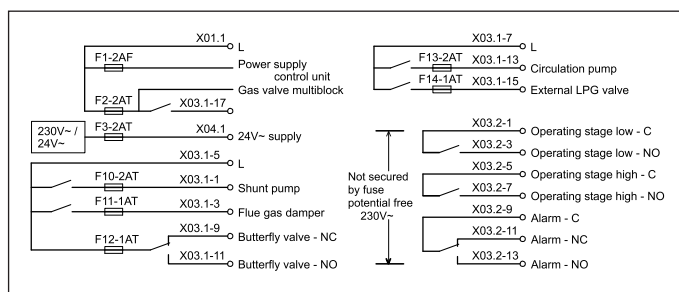

fig. 15 fuse plan

The boiler fuse F_a is located behind / next to the 230V terminal strip. This fuse de-energises the whole boiler and has a rating of 10 AT.

The fan has Power Factor Control (PFC) ensures that the mains supply is distributed more uniformly) and is fused with a 6.3 AT fuse F_b (behind / next to the 230V terminal strip).

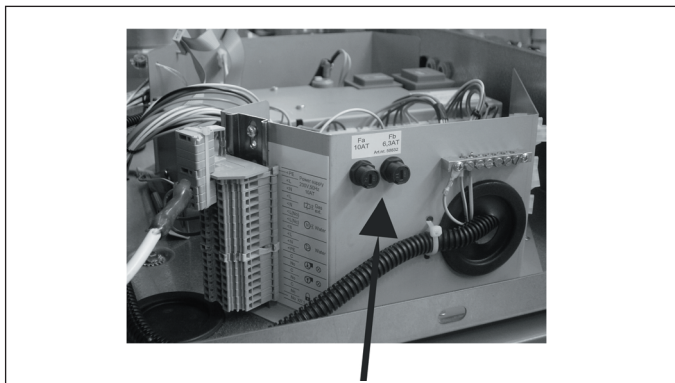

fig. 16 Position Fuses F_a and F_b

8.2.5 Temperature control

The Remeha Gas 310 ECO is equipped with electronic temperature control based on flow, return, boiler block and flue gas temperature sensors. The flow temperature is adjustable between 20 and 90°C (factory setting 90°C).

8.2.6 Low water level protection (flow and content)

The Remeha Gas 310 ECO is equipped with low water protection based on temperature differences (ΔT) between flow and return. When the $\Delta T = 25^\circ\text{C}$ (factory setting) the boiler starts modulating down so that it remains operational as long as possible. When the $\Delta T = 40^\circ\text{C}$ the boiler will be at part load. If the ΔT continues to rise and reaches 45°C , the boiler shuts down (not a boiler failure, see section 12.4) and will restart when conditions return to normal.

If the boiler is fired dry, it will go to high temperature lock out, failure code $\boxed{9} \boxed{7}$.

8.2.7 High limit protection

The high limit temperature protection device switches off and locks out the boiler (showing a flashing fault code, see section 14.4 for details) when the flow temperature exceeds the high limit set point (adjustable parameter, see section 13.2.10). When the fault is corrected, the boiler can be restarted by using the **reset**-key on the control panel.

8.2.8 Air pressure differential sensor (LDS)

At the start of a heat demand the system checks whether the LDS input is open. If not, there are (max.) 4 restarts, before the boiler is locked out ($\boxed{E} \boxed{6} \boxed{7}$). If the LDS input is open, the fan will speed up and a pressure difference is built up across the boiler. When the LDS control speed is reached the LDS input must close. If not, there are (max.) 4 restarts, before the boiler is locked out ($\boxed{E} \boxed{0} \boxed{8}$). Once started the LDS function is switched off for modulation purposes.

8.3 Connections

The terminal strips and boiler connectors can be seen once the control box cover is removed. The left-hand terminal strip (X29) is used for 24-volt connections. The right-hand terminal strip (X27) is used for 230-volt connections. All external connections (low and high voltage) are made on these terminal strips (see fig. 17). The various connection options are detailed in the following sections.

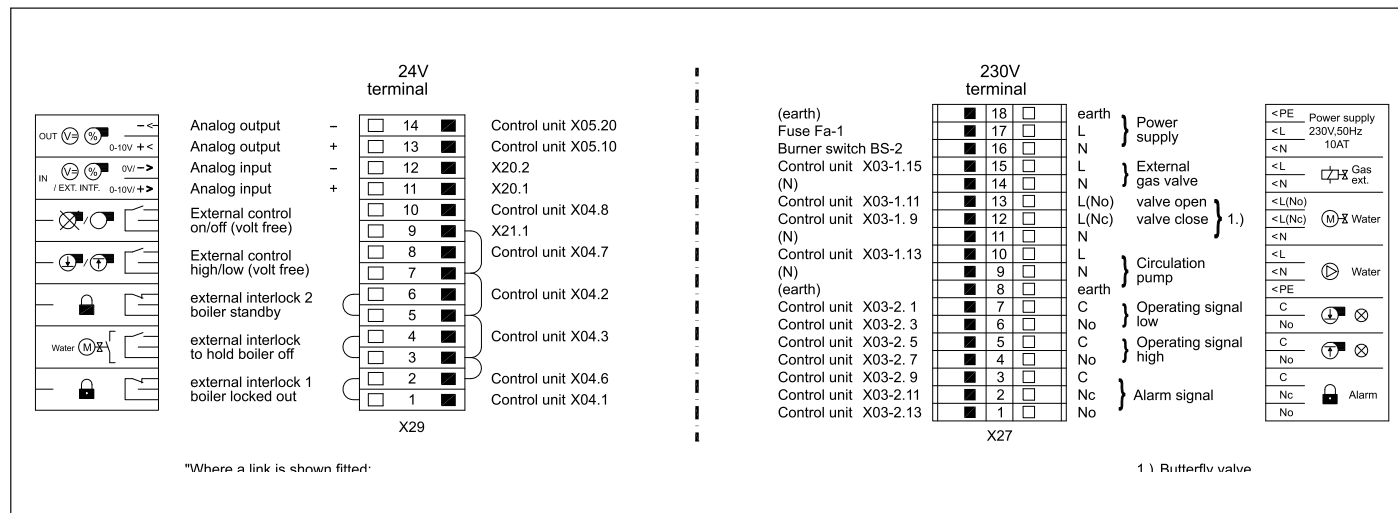

fig. 17 Terminal strip

04.31H.79.00001

Remeha Gas 310 ECO

8.4 Wiring diagram

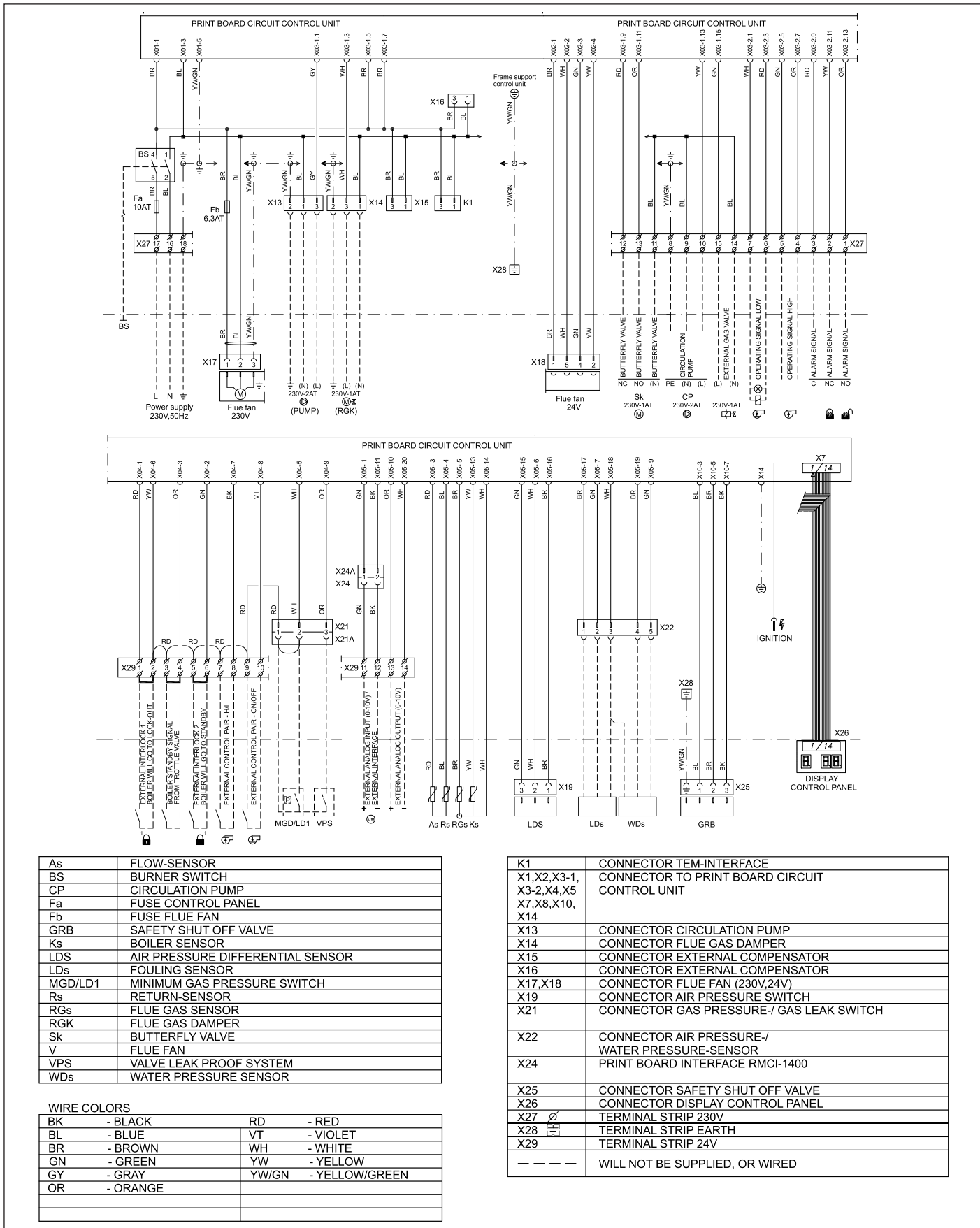

fig. 18 Wiring diagram

04.31H.SC.00001

8.5 Switch sequence diagram

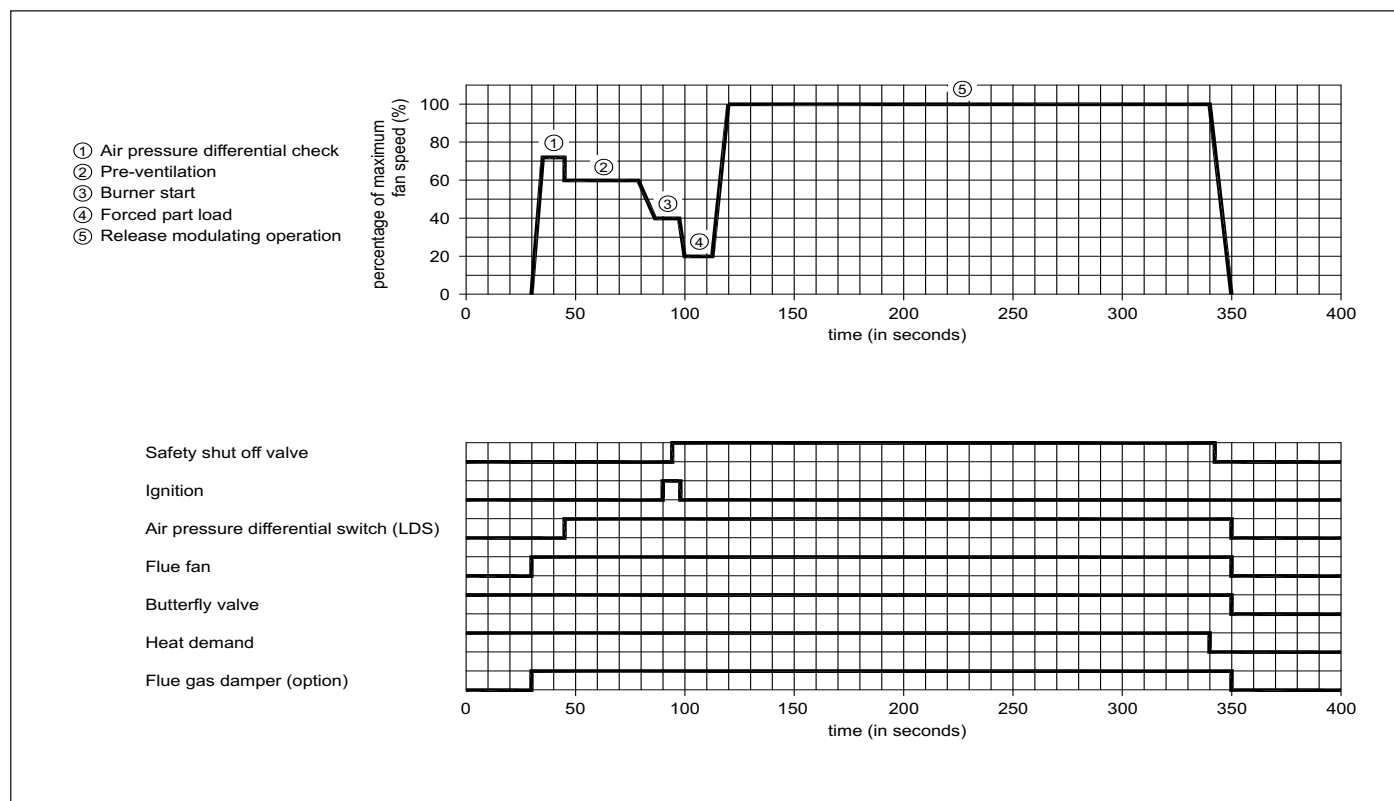

fig. 19 Switch sequence diagram

04.31H.79.00003

8.6 Boiler control

8.6.1 Introduction

The Remeha Gas 310 ECO can be controlled using one of the following methods:

- Note:** when using on/off control the boiler will also modulate to maintain the flow temp set point (parameter H_1)
- Fully modulating, where the output modulates between the minimum and maximum value on the basis of the flow temperature defined by the modulating controller.
- Analog control (0-10 volts), where the heat output or temperature is controlled by a 0-10 volt signal.
- On/ off control, (one-volt free relay) where the heat output modulates between the minimum and maximum value on the basis of the flow temperature set in the boiler.
- High/ low control, (two volt free relays) where the boiler is controlled by means of a 2-stage controller at part load and full load.

In all cases, modulation is based on the required flow temperature and there is a ΔT dependent output control with the following characteristic.

Up to a ΔT of 25°C (factory setting, parameter H_1) the boiler operates at full output. Between $\Delta T_{full\ load}$ and $\Delta T_{part\ load}$ the output reduces in linear fashion (see fig. 20).

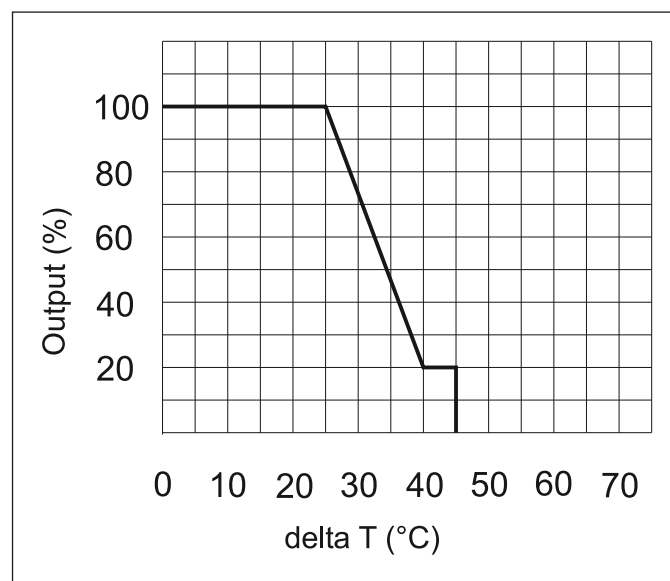

fig. 20 Output control characteristic

pdf

Remeha Gas 310 ECO

8.6.2 Modulating controls general (two wire control)

To make full use of the boiler's modulating feature, an **OpenTherm®** or a **rematic®** control can be connected. These controls will provide optimised time and weather compensation to achieve maximum efficiency and minimum boiler cycling whilst maintaining design condition within the building. An optional **OpenTherm®** or **rematic®** interface must be integrated in the boiler control box.

A. OpenTherm®

Celcia 20 - An optimising/ weather-compensated boiler control for single boilers. This compensator can regulate the boiler output against outside weather conditions, and provide time and temperature control over the DHW. The compensator is mounted in a reference room (uses an internal sensor to monitor room temperature) and is interfaced to communicate with the boiler's controls via the two wire serial interface. On site connection of the supplied outside and common flow sensors complete the installation. Set the **[X]** value of the boiler control operation parameter **[R]** to **[1]**.

Note: Please refer to the relevant control leaflet for optimising/ compensation settings.

B. rematic® modulating multiple boilers controller

rematic® 2945 C3 K - An optimising/ weather-compensated boiler control for multiple boilers (up to a max of 8). This compensator can regulate the boiler output against outside weather conditions, and provide time and temperature control over the DHW. The compensator is mounted in one of the boilers and is interfaced to communicate with the boiler's controls via the supplied adapter. On site connection of the supplied outside and common flow sensors complete the installation. Set the **[X]** value of the boiler control operation parameter **[R]** to **[1]**.

Note: Please refer to the relevant control leaflet for optimising/ compensation settings.

8.6.3 BMS Analog control (0-10 Volt DC)

Input resistance $R_{in} = 66 \text{ k}\Omega$.

The heat output modulates between the minimum and the maximum value on the basis of the voltage supplied by an external analog (0-10V) input. To control the boiler with an analog signal, the signal has to be connected on terminals X29-11 (+) and X29-12 (-) of the terminal strip in the instrument panel.

⚠ Important!!! When analog control is opted, the on/off-contact and the high/low-contact have higher priority (e.g. frost protection).

Temperature based (20 to 90 °C) set the **[X]** value of the boiler control operation parameter **[R]** to **[4]**. To set the ratio between voltage and the desired flow temperature (see par. 13.2.5 and fig. 21).

0 to 0.9 Volt = boiler off
1 Volt = Flow temperature set point 10 °C
8 Volts = Flow temperature set point 80 °C

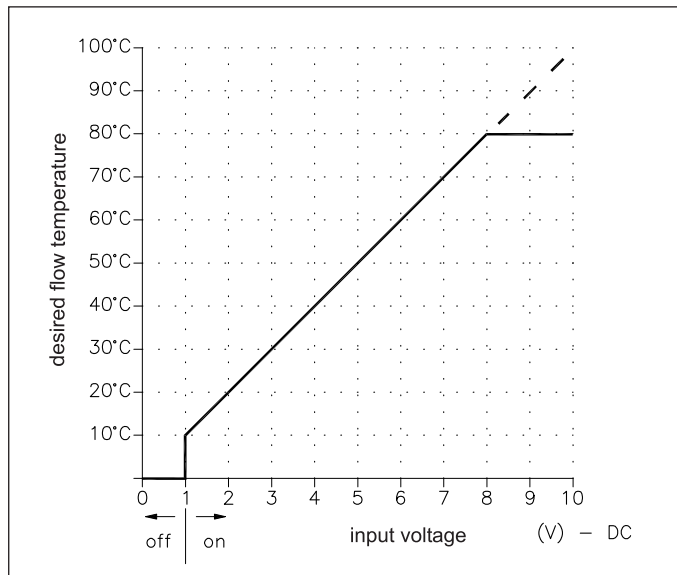

fig. 21 Temperature control via analog (0-10 Volt) signal

Output based - fixed parameters (20 to 100%), Set the **[X]** value of the boiler control setting parameter **[R]** to **[5]** (see fig. 22).

- 0 to 1.9 Volt = boiler off
- 2 Volt - 10 Volt = boiler modulates between 20 and 100% on demand.

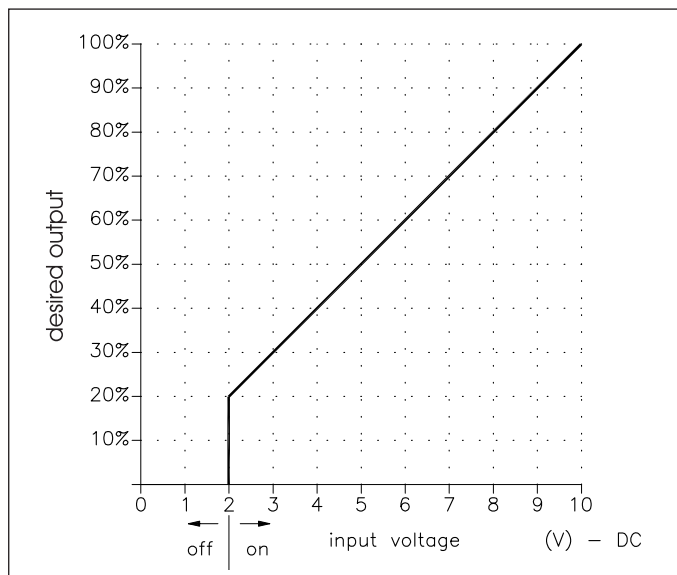

fig. 22 Output control via analog (0-10 Volt) signal

8.6.4 On/ off control (1 x no volt switched pair)

The heat output modulates between the minimum and the maximum value based on the set flow temperature, terminal connections X29-9 and X29-10.

Set the **[X]** value of the boiler control operation parameter **[R]** to **[3]** (on/ off).

8.6.5 High/ low control (2 x no volt switched pairs)

The heat output is controlled between part load (50%, adjustable) and full load, by means of a two-stage controller, terminal connections X29-9 and X29-10 low fire; X29-7 and X29-8 high fire.

Set the \boxed{X} value of the boiler control operation parameter \boxed{A} to $\boxed{2}$. The output percentage on which the boiler runs on low fire, can be adjusted with parameter \boxed{Y} (low fire start point as percentage) in the setting mode. The 'high fire' percentage is dependent of the maximal adjusted output, see setting mode, parameter \boxed{E} (maximum output). During this 'high' state modulation on adjusted flow temperature is released.

8.7 Other inputs

8.7.1 Shut down input

As standard the boiler is supplied with a shut down interlock carrying a 24 Volt AC boiler control circuit. This input does not require manual re-set.

Any external devices required to stop the boiler (e.g. limit switches of throttling valves, minimum gas pressure switches) should be wired in series and connected to terminals X29-5 and X29-6, breaking the circuit will activate the safety interlock and put the boiler into a shut-off condition with code \boxed{b} $\boxed{8}$ $\boxed{8}$. If this input is being used, the wire bridge must first be removed.

8.7.2 Lock-out input

As standard the boiler is supplied with a lock out interlock carrying a 24 Volt AC boiler control circuit. This input requires manual re-set if activated.

Any external devices required to stop the boiler (e.g. maximum gas pressure switch) must be volt free and should be wired in series and connected to terminals X29-1 and X29-2. Breaking the circuit will activate the safety interlock and put the boiler into a lock out condition, failure code \boxed{f} $\boxed{2}$ requiring manual intervention to re-set it. If this input is being used, the wire bridge must first be removed.

8.7.3 External interlock

As standard the boiler is supplied with an external interlock carrying a 24 Volt AC boiler control circuit.

Any external devices required to prevent the boiler from operating (e.g. boiler room ventilation air flow switch, or butterfly valve end switch) must be volt free and should be wired in series and connected to terminals X29-3 and X29-4, breaking the circuit will prevent the boiler from starting. Boiler does not go to lockout.

If this interlock is being used, the wire bridge must first be removed.

8.7.4 Other outputs

8.7.5 Analog output

Depending on the option settings in the service level (see section 13.2.13), the analog output signal is able to transmit the following values:

Output signal	Description
0 volts	Boiler off
0.5 volts	Alarm signal/lock-out
1.0 volts	Shut-off
2.0 - 10 volts	Output between 20 and 100% or flow temperature of 20 to 100 °C

table 10 Analog output signal

This output relates to terminals X29-13 (+) and X29-14 (-).

8.7.6 Operation signal

As standard the boiler is supplied with internal relays to indicate boiler run and boiler on high fire.

The relay contacts are volt free and close to confirm operation.

For the "boiler Low fire" signal connect to terminals X27-6 and X27-7.

For the "boiler High fire" signal' connect to terminals X27-4 and X27-5.

Contact load:

- Maximum voltage: 230 V.
- Maximum current: 1 A.

For ON/OFF signal: set parameter \boxed{L} to 6000 rpm.

8.7.7 Common alarm (lock-out)

As standard the boiler is supplied with an internal change over relay to indicate common alarm.

The relay contacts are volt free and can be connected to confirm operation with closed or open contacts.

For the alarm signal indication "closed contacts" connect to terminals X27-3 and X27-1.

For the alarm signal indication "open contacts" connect to terminals X27-3 and X27-2.

Contact load:

- Maximum voltage: 230 volts.
- Maximum current: 1 Amp.

8.7.8 External gas valve control

As standard the boiler is supplied with an internal relay that is energised when there is a heat demand, this applies a 230V supply to terminals X27-15 (live) and X27-14 (neutral). The relay is de-energised when the gas valve multiblock closes at the end of the heat demand. Additional external interlocks (by others) may be required in a multi boiler installation.

⚠ Important!! This supply cannot be used to control an external gas valve if it supplies other appliances. Contact load:

- External gas valve voltage: 230 Volts.
- Maximum current: 1 Amp.

8.8 Options/ accessories

8.8.1 System pressure sensor

The system pressure sensor shuts down the boiler (with shut-off code **[6][6][2]**) when the minimum water pressure is reached (adjustable 0.8 to 6.0 bar - factory setting 1.0 bar, see *section 13.2.12*). The hydraulic pressure sensor must be connected to the 5-pin female plug X22 on the 24-volt terminal strip.

Press the **▶▶▶** and **←** keys simultaneously for two seconds to indicate the presence of the hydraulic pressure sensor in the control unit.

⚠ Important!!! The system pressure sensor is suitable for pressures up to 4 bar

⚠ Important!!! This function is only operational when a system pressure sensor is connected and activated (parameter **[J]**).

8.8.2 Gas valve leak proving system VPS

The gas valve leak proving system checks and operates the safety valves on the gas valve multiblock. The test takes place before the boiler pre-ventilation phase. In the event of a leak between the two safety valves in the gas valve multiblock, the boiler will lock out and show failure code **[8][9]** or **[9][0]** on the display. The gas valve leak proving system must be fitted to the boiler and connected to the 3-pin female plug X21 on the 24 volt terminal strip and the control set to recognise it using parameter **[J]** in setting mode (see *section 13.2.13*).

⚠ Important!!! This function is only operational when a gas valve leak proving system is connected and activated (parameter **[J]**).

8.8.3 Minimum gas pressure switch (suitable for gas pressures up to 30 mbar)

The minimum gas pressure switch (set to 17 mbar) shuts down the boiler (shut-off code **[6][2][6]**) if the inlet gas pressure becomes too low. The minimum gas pressure switch must be connected to the 3-pin female plug X21 on the 24-volt terminal strip. The connection is automatically detected by the boiler control.

8.8.4 Flue gas damper

In a cascade configuration, the flue gas damper prevents flue gases from being discharged through a non-operating boiler. Therefore, the boiler can be installed on an over pressure flue system (Over pressure flue systems enable much smaller diameter flue ducts to be used).

The flue gas damper must be connected to the 4-pin female plug X14 on the 230-volt terminal strip.

8.8.5 Return butterfly valve (not Broag supply)

A butterfly valve can be installed in the return for each boiler module to ensure that a non-operating boiler module is hydraulically disconnected from the system. When

the return butterfly valve is fully open, the valve end switch contact is closed, allowing the boiler to run.

The return butterfly valve must be connected to terminals X27-11 (neutral), X27-12 (power close) and X27-13 (power open) on the 230-volt terminal strip.

The end switch on the return butterfly valve must be connected to the external interlock terminals X29-3 and X29-4 (first remove bridge). After boiler shut-off, the power supply will remain on X27-13 keeping the valve open during the post-circulation time of the pump (set point code **[2]**), then switch to X27-12 to close the valve (this remains valid even if no pump has been connected to the control box).

Also see *section 8.9.1* and *section 13.1.2*

8.9 Other connections

8.9.1 Boiler or System pump control

The Remeha Gas 310 ECO has a facility to provide a power supply (230V Max 2 amps) to run or control an external boiler or system pump.

The boiler control will run the pump once every 24 hours when the boiler not enabled to prevent sticking and will also provide a run on period at the end of a heat demand (parameter **[2]**, see *section 13.1.2*).

⚠ Important!! phase/ neutral sensitive!

⚠ Important!! For multiple boiler installations the system pump cannot use this power supply. If the boiler shuts down the system pump will also shut down.

Contact load terminals X27-9 (neutral) and X27-10 (live):

Voltage : 230 volts

Maximum current : 2 A.

The hydraulic resistance of the boiler at a ΔT of 11°C and 20°C for the various output variants of the Remeha Gas 310 ECO can be found in *table 02, section 4.2*

8.9.2 Frost protection

The boiler must be installed in a frost-free area to prevent freezing of the condensate drain.

If the temperature of the heating water drops too low the integrated boiler protection activates under the following conditions.

If the boiler flow temperature:

- is below 7°C, the external heating pump connected to the boiler is switched on by the control unit;
- is below 3°C, the boiler is switched on at minimum capacity;
- exceeds 10°C, the boiler and heating pump are switched off again. The pump now has a fixed post-circulation time of 15 minutes.

⚠ Important!! This frost protection only protects the boiler. Other measures must be employed to protect the building and system and will depend which parameters are set or what form of external controls are in use.

9 INSTALLATION INSTRUCTIONS FOR GAS INSTALLER

9.1 Gas connection

The Gas 310 is suitable for use with natural gas only. The gas connection is at the top of the boiler (see fig. 02). The boiler is fitted with a gas filter as standard to prevent dirt from contaminating the gas valve or burner assembly. An isolating main gas cock must be installed in the vicinity of the boiler.

9.2 Gas pressures

The boiler main gas valve can accept an inlet pressure up to 30 mbars, but MUST have a Min of 17 mbar at the gas filter inlet test point when the boiler is operating at max output. Pressures below this level can result in lockouts (for multi gas appliance installations this Min pressure must be available at each boiler with all gas appliances firing on max output).

Boilers with 7, 8 and 9 sections can also work with gas pressures up to 100 mbar. In such case, the boiler has to be adjusted for a corresponding CO₂ setting. Tolerances on gas arrival pressures are ± 5 mbar.

9.3 Gas/ air ratio control

The boiler has a pressure differential gas/ air ratio control. This gas/ air ratio control maintains the correct balance of gas and air quantities to the burner at a constant level under variable loads. This ensures clean and reliable combustion and high part load efficiency across the entire load range.

Minimum airflow is monitored before a start by an air pressure differential sensor.

10 COMMISSIONING

10.1 Initial lighting

1.  Isolate main power supply.
2. Remove the casings on the inspection side.
3. Open the main gas valve.
4. Check the electrical connections including earth.
5. Fill the boiler and the system with water (approximate 1.0 bar).
6. Vent the system.
7. Fill the siphon with water.
8. Check the flue gas discharge connection and air inlet duct or air supply connection.
9. Vent the gas pipe.
10. Open the gas cock to the boiler.
11. Check the inlet gas pressure PI (see fig. 23).
12. Check the gas connection for gas tightness.
13. Switch on the mains supply to the boiler.
14. Switch on the boiler operating switch.
15. Switch on the heating pump and check the installation position and direction of rotation.
16. Adjust the boiler controls to heat demand.
17. The boiler should start with the run sequence indicated in the code-display:

 = Boiler neutral position.

 = Butterfly valve opens, if connected;

Wait for minimum gas pressure switch to close;

Neutral position check of air pressure differential sensor;

Flue gas damper opens (if applicable);

The fan runs and the boiler waits until sufficient air

transport is established; the air pressure differential sensor must switch to guarantee sufficient airflow.

 = Gas valve leak proving system (if applicable).

 = Pre-purging.

 = Heating pump starts running; Ignition of the gas/ air mixture.



 = The burner is firing.

17.a Check and correct, if necessary, the boiler for correct gas/air ratio set-up. Checking takes place on full and part load, adjustment takes place only on the gas valve multiblock. For checking and adjusting are required: an electronic CO₂-gauge (on the basis of O₂) and a gas pressure gauge.





Note that the opening (see fig. 24) around the measuring probe is sealed properly during measurement.

Note also that measuring the O₂ levels in the flue gas is necessary, because direct measurement of CO₂ can lead to inaccuracies due to varying CO₂ levels in the natural gas.

Connect the gas pressure meter between measuring point PG on the underside of the gas valve multiblock and measuring point PL on the venturi (see fig. 23), ensuring the connections are gas tight.

17.b Run the boiler at full load (forced mode 'high') by pressing the  and [+]-key simultaneously for 2 seconds. The letter  will now appear on the display.

Remeha Gas 310 ECO

- 17.c When full load is reached, measure ΔP gas at measuring point P on the underside of the gas valve multiblock and at the measuring point PL on the venturi and compare to the value in *table 11*. Adjust if necessary using the  adjustment screw on the gas valve multiblock.
- 17.d Check CO₂-percentage (O₂-percentage) against *table 11*. If the values exceed the given tolerances, adjust according to *fig. 23*. Check the flame through the inspection glass, the flame must not blow off.
- 17.e Run the boiler at part load (forced mode 'low') by pressing the  and [-] keys simultaneously for 2 seconds. The letter  will now appear on the display.
- 17.f When part load is reached, measure ΔP gas at measuring point P on the underside of the gas valve multiblock and at measuring point PL on the venturi and compare to the value in *table 11*. Adjust if necessary using the  adjustment screw on the gas valve multiblock.
- 17.g Check CO₂-percentage (O₂-percentage) against *table 11*. If the values exceed the given tolerances, adjust according to *fig. 23*.

Check the flame through the inspection glass, the flame must not blow off.

Repeat the check starting from point 17 b. until the readings match the values in the tables.

Contact our Service Department if deviations cannot be corrected.

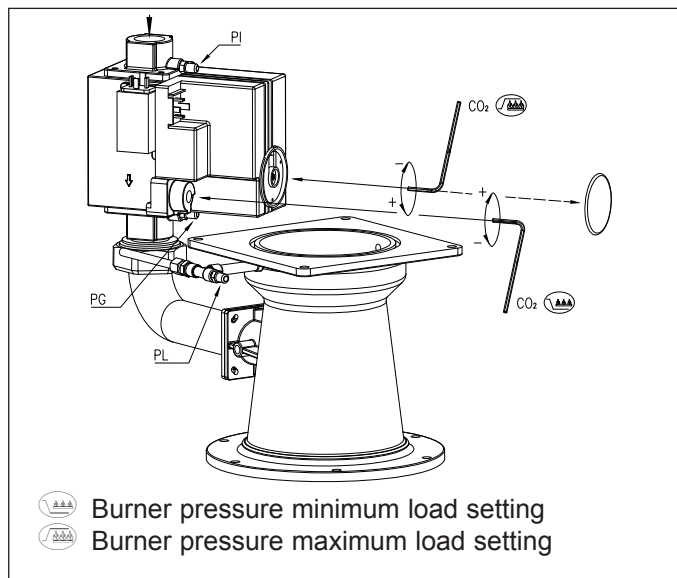

fig. 23 Gas valve multiblock adjustment points
00.31H.79.00006

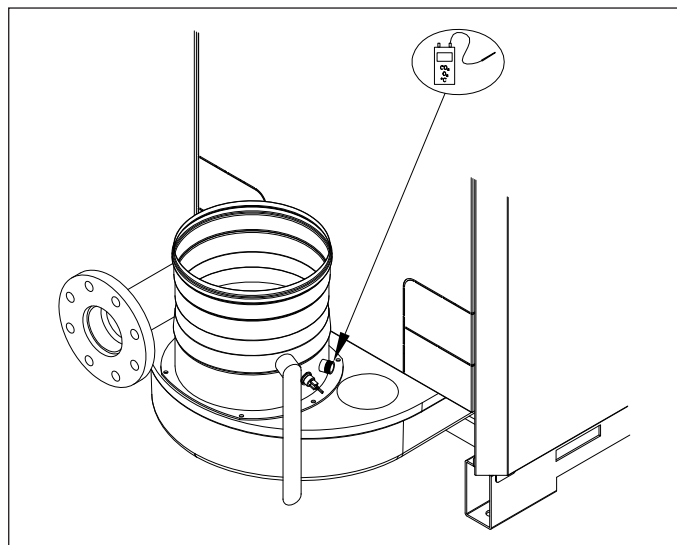



fig. 24 Flue gas measuring point
00.31H.79.00007

	Natural gas (G20)	
	Full load (100%)	Part load ($\pm 20\%$)
Guide value CO ₂	9.0%	9.0%
Adjust at	$\pm 0.5\%$	$\pm 0.5\%$
Set to	$9.0 \pm 0.15\%$	$9.0 \pm 0.15\%$
Guide value O ₂	4.8%	4.8%
Adjust at	$\pm 0.5\%$	$\pm 0.5\%$
Set to	$4.8 \pm 0.25\%$	$4.8 \pm 0.25\%$
ΔP 5 sections (Pa)	1300 ± 150	70 ± 20
ΔP 6 sections	1000 ± 150	45 ± 20
ΔP 7 sections	950 ± 150	50 ± 20
ΔP 8 sections	1250 ± 150	75 ± 20
ΔP 9 sections	1550 ± 150	80 ± 20

Note: These are indicative values, not approval or rejection values.

table 11 Setting data CO₂ and O₂

17. **h** Remove measuring equipment and seal test points.
18. Check gas leakage control and minimum gas pressure switch (if installed):
Parameter  must be set to a value greater than or equal to 8, depending on the connected options (see section 13.2.13).
Then set the gas leakage control pressure switch to a switch pressure equal to 50% of the inlet pressure. Check that the measured inlet pressure is not the (higher) closing pressure.
19. Return the boiler to 'user level' by pressing the **reset** key.
20. Heat the system to approximately 80°C and switch off the boiler.
21. Bleed the system and check the water pressure.
22. The boiler is now ready for operation.
23. Set the boiler controls to the required values.
24. Send the commissioning reports to Broag.



Note:

The Remeha Gas 210 ECO is supplied with a number of factory default settings that should be correct for most installations. If other setting values are required: see sections 13.1. and 13.2.



The following operating situations are now possible:

25. **a** **Modulating operation:** The output of the boiler modulates on the basis of the flow temperature, asked by the modulating control (see 'Note' in point 25c and section 8.6.2).
25. **b** **High/low operation:** The boiler is operating at part load or full load, depending on the heat demand (see section 8.6.5). On the safety boundaries the boiler is going to modulate.
25. **c** **On/off operation:** the boiler modulates between minimal and maximal output on the basis of the flow temperature pre-set on the boiler (see section 8.6.4).



Important!!

The boiler will initially operate in forced part load. The factory setting for forced part load time is 30 seconds. This setting is correct if modulating controllers are used (see point 25a). A forced part load time of 3 minutes is recommended for on/off operation (setting mode, parameter , see section 13.2.3).

25. **d** **0-10 V operation:** Depending on the adjustments, two situations are possible (see section 8.6.3):
- The given off output varies linear with the sent signal, 2V = 20%, 10V = 100%
 - The given off flow temperature varies linear with the sent signal (depending on parameters  and ); example: 0V = 0°C, 10V = 100°C.

The boiler modulates on the basis of the set flow temperature (setting range 20°C to 90°C) and a maximum ΔT protection.

10.2 Shutdown

1. Switch off the on/ off switch of the boiler. With this, a possible boiler control will be without tension also.
2. Close the gas cock.



Important!!

When the boiler is out of operation, it is not protected against frost!

11 CONTROL AND SAFETY EQUIPMENT

11.1 General

The boiler is supplied with a standard set of defaults pre-programmed for normal operation but can be tailored by the Engineer to suit most site conditions. These values are set and read, using the built-in instrument panel or with a notebook computer or PDA (with optional software and interface).

For security the control has three levels of access:

1. User level - free access
2. Service level - access with service code by qualified personnel
3. Factory level - access by PC with factory code (Remeha only)

11.1.1 Instrument panel layout

The instrument panel consists of (see fig. 25):

- 1 Operation switch
- 2 PC/ PDA connection for Recom setting and monitoring
- 3 Facility for incorporating a weather compensator

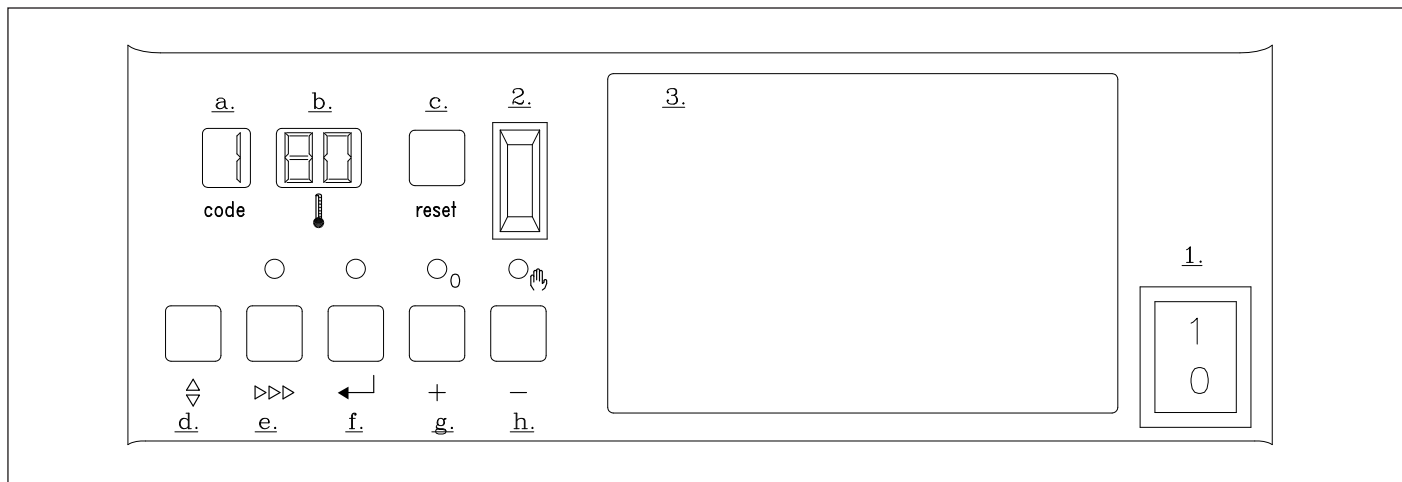

fig. 25 Instrument panel

00.31H.79.00010 (fig. 2)

The functions of the keys and read-out windows (a to h) are explained below.



A summary of the key functions can be found in section 16.1 that is helpful when stepping through the modes.

a. code window:

display at user level:

- operating mode only digit or letter
- setting mode digit or letter with steady dot
- read-out mode digit or letter with flashing dot
- shut-off mode letter letter
- forced mode 'HIGH' letter 'HIGH' letter
- forced mode 'LOW' letter 'LOW' letter
- failure mode flashing digit (current fault)

display at service level:

- failure mode flashing digit (failure memory)
- counter mode alternating + +
- shut-off mode alternating digit and dot in first section

b. window displaying:

- temperatures
- settings
- shut-off or failure codes

c. reset key:

- reset/unlock key

d. key (mode key):

- program function; use this key to select the required mode

e. key (step key):

- program function; use this key to select a parameter within the mode

f. key (store key):

- program function; store key for set data

g. [+] key:

- program function; increase setting

h. [-] key:

- program function; decrease setting
- switch function; manual or automatic operation

11.1.2 LED indicators

The instrument panel has 4 indicating LED's with the following functions:

- The LED above the [-] key (in the  symbol); when illuminated green confirms the boiler is in manual override (see section 11.2).
- The LED above the [←→] key indicates that "24 hour pump operation" has activated the heating pump (and the shunt pump if required).
- The LED above the [+] key flashes if the optional hydraulic pressure sensor detects that the water pressure is too low.
- The LED above the [▶▶▶] key flashes if there is no communication with the code key (codekey not connected).
- Two LED's flash green when there is no communication anymore between codekey and control unit. The boiler will keep on operating. Only after the power supply was switched off and back on, the boiler will refuse to operate.

11.2 Switch function keys

Some keys on the instrument panel have dual functions, i.e. a programming and a switch function.

The programming function is described in section 13.

The switch function (on or off) is activated by pressing down the relevant key for 2 seconds. Whether the function is switched on or off is indicated by the indicator for the key, which is either lit or not lit, or by the appearance of a letter in the **code** window.

11.2.1 Manual/automatic operation

If the [-] key is pressed for 2 seconds the boiler will switch on, even if there is no heat demand from an external control. The green LED above the key is on continuously to indicate manual heat demand (central heating bridged internally). When the [-] key is pressed for 2 seconds again the boiler will return to automatic central heating operation (green LED off).



During manual operation the flow temperature cannot exceed its pre-set maximum value. This is to protect the boiler and the system. Parameters can be changed during manual operation.



Important!! If an external heating pump is not connected to the control unit, the pump will not be switched.

11.2.2 Forced mode 'high' (H □ □ □)

By pressing the  and [+] key simultaneously in operating mode during 2 seconds, the boiler will run at maximum power. The letter **H** will now appear on the display. To protect the boiler and the system, the flow temperature cannot exceed its pre-set maximum value. This is. Parameters can be changed in this mode. By pressing the [+]- and [-]-keys simultaneously, the boiler will return to operating mode.

Following a manual override the boiler will return to normal (auto control) if no keys are used within a 15-minute period.

11.2.3 Forced mode 'low' (L □ □ □)







By pressing the  and [-]-key simultaneously in operating mode, the boiler will run at minimum power. The letter **L** will now appear on the display. To protect the boiler and the system, the flow temperature cannot exceed its pre-set maximum value. This is. Parameters can be changed in this mode.

By pressing the [+]- and [-]-keys simultaneously, the boiler will return to operating mode.

Following a manual override the boiler will return to normal (auto control) if no keys are used within a 15-minute period.

11.3 Display of values

The display has only two digits available therefore values over this are displayed as follows:

- values from 00 to 99 will be indicated without any punctuation marks
- values from 100 to 199 will be indicated by a dot between both digits e.g.  = 100,  = 110,  = 199
- values from 200 to 299 will be indicated by a dot behind every digit e.g.  = for 200,  = 210,  = 299
- values over 300 will be indicated by showing the thousands, hundreds, tens and units in separate alternating pairs. (see section 12.2 and 12.5)
- negative values (for instance when using an external sensor or when sensors are not connected) will be indicated by a dot behind the last digit, e.g.  indicates -10.

12 OPERATING MODE

12.1 Operating mode (X □ □)



During normal operation the **code**-display shows the status (position in cycle) of the boiler, with the  -display indicating the actual flow temperature.

The digits or letters in the code-display have the following meaning:

Code	Description
	Standby; there is no heat demand from control system
	Pre-ventilation (pre-ventilation time 30 seconds, post ventilation time 3 seconds)
	Ignition
	The burner is firing (flame detection)
	n/a
	Waiting mode; check for sufficient air flow using fan and air pressure differential sensor (LDS)
	Control stop (burner off + post ventilation) : - flow temperature T1 > setpoint + 5°C - flow temperature T1 > desired setpoint modulating control + 5°C - flow temperature T1 > parameter - difference flow T1 and return T2 > 10°C (factory setting); Starting condition is ≤ 10 °C
	End of heating demand, pump run on time. During cycling prevention delay-time the boiler will remain in state and will not react to heat demand.
	n/a
	Shut-off mode (see section 12.4)
	Forced full load (HIGH)
	Forced part load (LOW)
	Gas leakage control
	Burner cooling

table 12 Operating codes

12.2 Read-out mode (X □ □)

Read-out mode is used to display various values. Press the  key until appears in the **code** window (dot flashes). Select the required code using the  key.

Code	Description	Read-out range/comments	Read-out (e.g.)
	Flow temperature (°C)	actual value	
	Return temperature (°C)	actual value	
	Flue gas temperature (°C)	actual value	
	Heat exchanger temperature (°C)	actual value	
	Flow temperature (set point, °C)	Calculated value	
	Heat demand status (1 st digit) and air pressure differential sensor (LDS, 2 nd digit)	= on/off-contact open = on/off contact closed = air pressure differential sensor open = air pressure differential sensor closed	
	Switch-on temperature for central heating operation (°C)	demanded value	

g	Requested (and permitted by boiler control) output (%) is displayed, irrespective of boiler control setting.	00 - 00 (=100%) demanded value	90
R	Calculated output (%)	10 - 00 (=100) (actual value)	87
b	Analog input voltage (volts)	00 - 00 (=100) ((actual value)	45
c	Control strategy (see section 12.3)	01 - 06	02
d	Current water pressure	00 - 60 (÷ 10 for bar), with hydraulic pressure sensor only (optional); with sensor not connected: 00	15 (=1.5 bar)
E	N/a		
F	Fan speed	06 - 60	40 00 (=4000*)
G	Ionisation level	00 - 99 (x 0.1 µA)	03
H	Unique boiler code	10 - 98	
I	pressure difference over air pressure differential sensor	00 - 80 (x 0,1 mbar)	13

table 13 Read-out mode user level

* The displayed value has 4 digits. The display alternately flashes from **F** 40 to **I** 00 with code indicating the value being read. In this example: fan speed 4000 r.p.m.

12.3 Control strategy **c**

During normal operation, the boiler control can operate according to a specific strategy. Most control strategies are meant to keep the boiler burning for as long as possible, regardless of changes in flow or flow problems, etc.

The control strategies can be viewed in read-out mode with code **c**.

- 1** = modulate up (control below ionisation limit)
- 2** = modulate down (maximum temperature difference between flow and return)
- 3** = minimum output (return temperature higher than flow temperature)
- 4** = modulate down (flue gas temperature too high)
- 5** = pump/ boiler on (frost protection)
- 6** = zero-flow protection 2 (minimum output)
- 7** = zero-flow protection 1 (modulate down)
- 8** = boiler block temperature too high (control stop)

12.4 Shut-off (**b** **X** **X**)

12.4.1 Shut-off

During shut-off, the **code** window displays **b** and the **i** window indicates the shut-off code.

! Important!! Shut-off is a normal boiler operating function and does not represent a boiler failure. However, this may indicate a system problem or an incorrect parameter setting.

12.4.2 Shut-off mode

In shut-off mode last shut-off and corresponding operating codes can be reviewed. With PC (version Recom PC and higher) or PDA the last six shut-off's can be reviewed.

During this particular mode both dots in the **i** window flash.

The last shut-off and corresponding operating codes and applicable temperatures are stored in the micro-processor memory and can be read out in shut-off mode as follows:

- Enter the service code **c** **1** **2** (see section 13.2).
- Press the **b** key until **b** appears in the code window (flashing digit with flashing dot).

Select the required step with the **>>>** key.

Remeha Gas 310 ECO





























Code		Description
		Shut-off code (see table 23)
		Operating code, at shut-off intervention (section 12.1)
		Flow temperature, at shut-off intervention
		Return temperature, at shut-off intervention
		Flue gas temperature, at shut-off intervention
		Boiler block temperature, at shut-off intervention
		Time from shut-off intervention (with PC software only)
		Ionisation level (analog), at shut-off intervention
		Operating hours (hundred thousands and ten thousands)
		Operating hours (thousands and hundreds)
		Operating hours (tens and units)
		Fan speed at shut-off intervention (thousands and hundreds)
		Fan speed at shut-off intervention (tens and units)

table 14 Shut-off mode in service level

The letters and numbers in the **code** window and the  window are explained in appendix 16.2.





12.5 Counter mode (, and) (service level)

12.5.1 General

The boiler control records various data on the combustion trend of the boiler. This data can be read out in counter mode. The following data can be read out:

- Hours run
- Number of successful ignition attempts
- Total number of start attempts
- Number of shunt pump operating hours
- Number of shunt pump starts
- Number of internal resets (control unit)
- Number of hours energised (control unit)

12.5.2 Reading out counter mode

First enter the service code    (see section 13.2). Press the  key until the required code (see table 15) appears in the **code** window.











	Hours run
	Number of successful ignition attempts
	Total number of start attempts
	Number of shunt pump operating hours
	Number of shunt pump starts
	Number of internal resets (control unit)
	Number of hours energised (control unit)

table 15 Counter mode codes

The counter has 6 digits. The **code** window displays the following (in sequence):
code figure, ,  with a value in the  window.



	Meaning of readout in  window
Code figure	Total number or total number of hours in hundred thousands and ten thousands
	Total number or total number of hours in thousands and hundreds
	Total number or total number of hours in tens and units

table 16 Counter mode readout

Example:

code window	 window	value
		210000
		5700
		53

This means 215753 Hours run

13 SETTING MODE

13.1 User level setting mode (X □ □)

Setting mode is used to change various settings to suit individual requirements. The required code is selected by pressing the \updownarrow key until $\boxed{1}$ appears in the **code** window. Select the required code with the \gggg key. Now press the $[+]$ key to increase a setting or the $[-]$ key to decrease a setting.

Press the \leftarrow key to store the new setting. The new value will flash twice in the ! window to confirm the setting.

Code	Description	Setting range and explanation if necessary	Factory setting
$\boxed{1}$	Flow temperature setpoint, see section 13.1.1	$\boxed{20}$ to $\boxed{90}^{\circ}\text{C}$ (boiler thermostat setting, also top heating curve setting if external sensor is used)	$\boxed{80}$
$\boxed{2}$	Pump run on setting, see section 13.1.2	$\boxed{00}$ = pump run on 10 seconds $\boxed{01} - \boxed{15}$ = pump run on in minutes $\boxed{99}$ = continuous pump operation	$\boxed{05}$
\boxed{R}	Boiler control setting, see section 13.1.3	Control mode (modulating-on/off-etc.)	$\boxed{31}$

table 17 Settings mode user level

! Important!! Changing $\boxed{2}$ and \boxed{R} should only be on design engineers advice.

13.1.1 Flow temperature ($\boxed{1}$)

The required flow temperature is adjustable from 20 to 90°C.

The following diagram shows a typical example of this procedure:

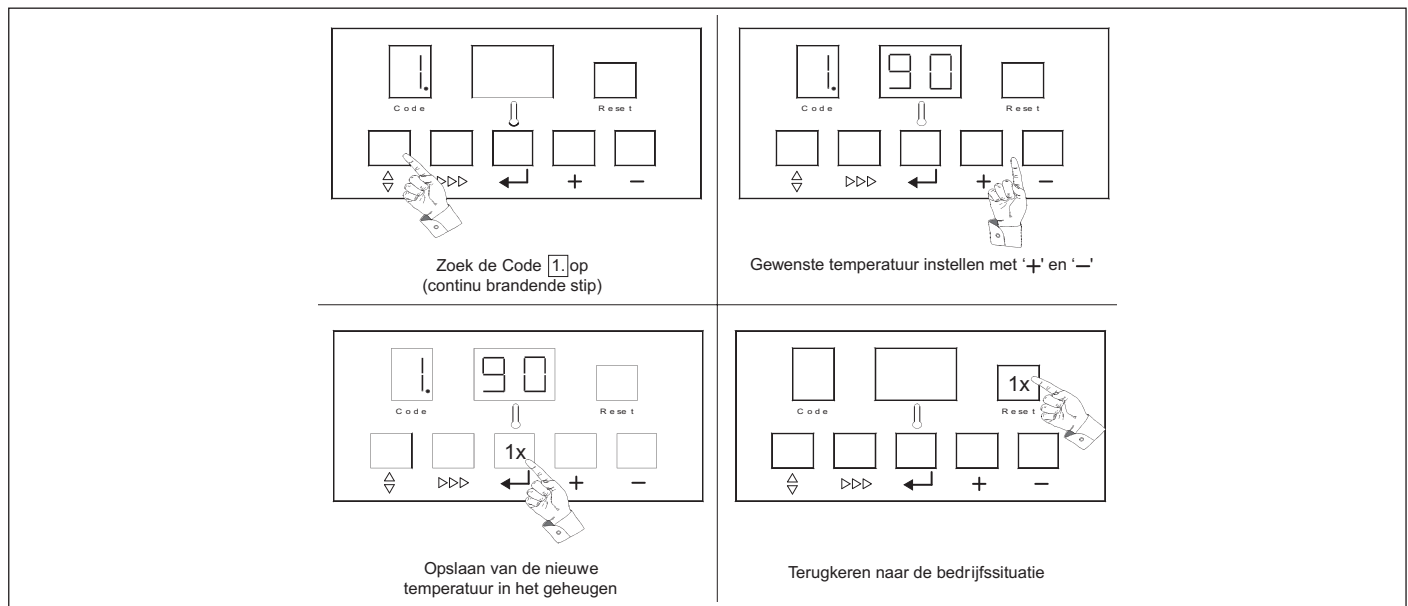

fig. 26 Setting flow temperature

pdf

Remeha Gas 310 ECO

13.1.2 Pump run on time (2)

Pump run on time can be adjusted (Please refer to installation contractor).

- Press the \diamond -key until the digit 2 (with dot) appears in the **code**-display.
- Press the $\triangleright\triangleright\triangleright$ -key until the digit 2 (with dot) appears in the **code**-display.
- Set the required value, using the [+]- and [-]-keys.
- Press the \leftarrow -key to store the new value (value will flash twice).
- Press the **reset**-key to return to operating mode.

Code	ⓘ	Description
2	00	Pump runs on for 10 seconds
2	XX	Pump runs on for 1 to 15 minutes (XX = 01 to 15)
2	99	Continuous pump operation

table 18 Adjustments pump run on time

13.1.3 Boiler control (R)

Setting mode, parameter R, can be set to different values (see table 19).

Proceed as follows to change the boiler control:

- Press the \diamond key until the number 1 (with dot) appears in the **code** window.
- Press the $\triangleright\triangleright\triangleright$ key until the letter R (with dot) appears in the **code** window.
- Use the [+] and/or [-] keys to specify the required setting.
- Press the \leftarrow key to store the new setting (flashes 2x to confirm).
- Press the **reset** key once to return to operating mode.

Code	ⓘ	Description	
R	X0	Heat demand off	X = 2, 3, 4 or 5
	X1	Heat demand on	X = 2, 3, 4 or 5
	2Y	On/off and High/low	Y = 0 or 1
	3Y	On/off and modulated on flow temperature	Y = 0 or 1
	4Y	External 0-10V analog signal on temperature	Y = 0 or 1
	5Y	External 0-10V analog signal on output %	Y = 0 or 1

table 19 Boiler control settings

Example: boiler control 41 indicates that the boiler is controlled by means of a 0 -10 volt signal modulated on the basis of flow temperature (X = 4). Heat demand is on (Y = 1).

13.2 Setting mode service level (only for the qualified service engineer) (X □ □)

To prevent accidental, unauthorised access by non-qualified persons the control system requires an input code to gain access to the second level of boiler control.

- Press the \diamond - and $\triangleright\triangleright\triangleright$ -keys simultaneously and hold. The **code**-display now shows a letter X with a random number in the ⓘ-display.
- While holding both keys pressed, set the ⓘ-display to 12, using the [+]- or [-]-keys and press the \leftarrow -key.
- The display will flash twice, confirming acceptance of the access code.
- Release the keys and X 12 will disappear from the display.

! Important!! Changing the pre-set values without reference to the tables contained in this manual may result in incorrect boiler operation.

- The service settings can now be reached by pressing the \diamond -key until the digit 1 (with dot) appears in the **code**-display. Set the required value, using the $\triangleright\triangleright\triangleright$ -key.
- To delete the service code, press the **reset**-key once.
- If no keys are pressed over a 15-minute period the service code will delete automatically.

Code	Description	Setting range	Factory setting
4	Minimum fan speed (hundreds), see section 13.2.1	06 - 60 (x 100 rpm)	5 sections: 1400 rpm 6 sections: 1500 rpm
5	Minimum fan speed (units), see section 13.2.1	00 - 99 (x 1 rpm)	7 sections: 1000 rpm 8 sections: 1050 rpm 9 sections: 1150 rpm
6	Maximum fan speed (hundreds), see section 13.2.2	10 - 60 (x 100 rpm)	5 sections: 5500 rpm 6 sections: 5600 rpm
7	Maximum fan speed (units), see section 13.2.2	00 - 99 (x 1 rpm)	7 sections: 3650 rpm 8 sections: 4200 rpm 9 sections: 4500 rpm
8	Forced part load running time, see section 13.2.3	01 - 30 (x 10 sec.)	03
9	Cycling prevention delay-time, see section 13.2.4	01 - 30 (x 10 sec.)	02 (=20 sec.)
a	Required flow temperature at 0 volts (analog signal), see section 13.2.5	50 (=50) to 50 (°C)	00
b	Required flow temperature at 10 volts (analog signal), see section 13.2.5	50 to 49 (=249) (°C)	00 (= 100)
c	Switch point high/low operation signal, see section 13.2.6 - If inferior value: signal "low fire" - If superior value: signal "high fire"	06 - 60 (x 100 rpm)	5 sections: 3500 rpm 6 sections: 3900 rpm 7 sections: 2500 rpm 8 sections: 2700 rpm 9 sections: 3500 rpm
d	Shunt pump post-circulation time, see section 13.2.7	00 = 10sec 01 to 15 = min 99 = continuous	00
e	ΔT from control stop point to start point, see section 13.2.8	05 - 30 (°C)	10
f	Maximum flue gas temperature, see section 13.2.9	80 - 20 (=120) (°C)	20 (= 120)
g	High limit temperature setpoint, see section 13.2.10	90 - 10 (=110) (°C)	00 = 100
h	Modulation start point ΔT, see section 13.2.11	10 - 30 (°C)	25
i	Minimum water pressure, see section 13.2.12	00 - 60 (x 0.1 bar)	08 (=0.8 bar)
j	Adjustments options/accessories, see section 13.2.13	00 - 15	00
l	"Low" fan speed with H/L control (parameter R = 21, see section 13.2.14)	06 - 60 (x 100)	5 sections: 1400 rpm 6 sections: 1500 rpm 7 sections: 1000 rpm 8 sections: 1050 rpm 9 sections: 1150 rpm
p	Boiler type; Appears only after replacing the control unit	50 - 98	depends on output variant

table 20 Service level setting mode

13.2.1 Minimum fan speed (**4** and **5**)

Parameter **4**, adjustable between 06 and 60 (x 100 rpm) and parameter **5**, adjustable between 0 and 100 (x 1 rpm).

This setting is only active if setting **21** has been selected in the boiler control: high/low control (see section 13.1.3). The value relates to the percentage output when the boiler is running at 'low'.

The percentage 'high' position depends on the set maximum central heating speed.

! Important!! Only make changes after consulting Remeha sales support department.

13.2.2 Maximum fan speed (**6** and **7**)

Parameter **6**, Adjustable between 10 and 60 (x100 rpm) and parameter **7** adjustable between 0 and 100 (x 1 rpm).

The maximum speed can be limited at a lower value in the software by changing parameters **6** and **7**.

! Important!! Only make changes after consulting Remeha sales support department.

Remeha Gas 310 ECO

13.2.3 Forced part load time (a)

Parameter Adjustable between 0 and 300 seconds. The boiler always starts with a specified output for a certain time. The boiler can then be sent to the minimum position (20% of output) for a specific period, independent of the heat demand.

13.2.4 Cycling prevention delay time (g)

Parameter g, Adjustable between 0 and 300 seconds. This value sets a minimum off time following a control stop / end of a heat demand to prevent cycling taking place. When after this delay time flow temperature lies less than 5°C above return temperature (check on water flow), the boiler will restart.

13.2.5 Required flow temperature at 0 - 10 volts (a and b)

Start point (0 volts): parameter a, adjustable between -50°C and +50°C.

This value sets the required flow temperature at 0-volt signal input.

End point (10 volts): parameter b, adjustable between +51°C and +249°C.

This value sets the required flow temperature at 10-volt signal input (restricted by the maximum flow temperature setpoint and the maximum output).

These settings only apply if boiler control 41 has been selected: 'external analog input 0-10V on the basis of flow temperature'.

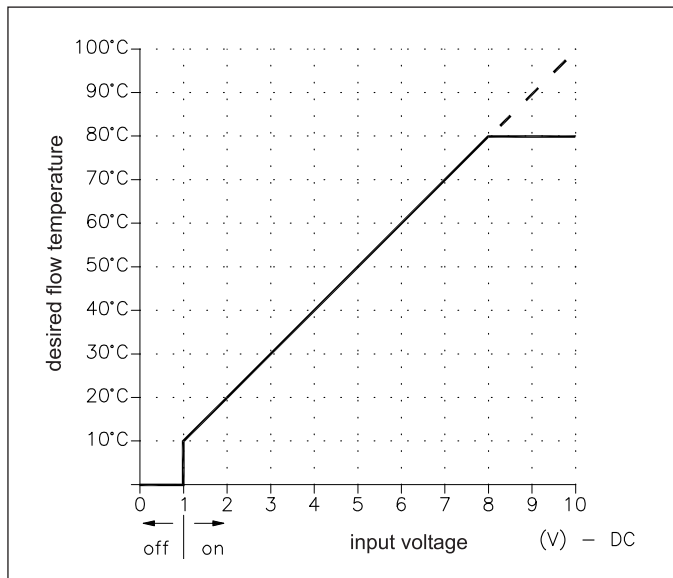

fig. 27 Temperature control via analog (0-10 Volt) signal

pdf

13.2.6 Switch point high/low operation signal (c)

Parameter c, adjustable between 0 and 60 (x 100) rpm. This parameter enables setting the switch point between "low fire" and "high fire". A fan speed below the set value will cause a "low fire" signal. A fan speed above the set value will cause a "high fire" signal. An "ON/OFF" signal can be obtained by setting parameter c to 6000 rpm.

13.2.7 Shunt pump post-circulation time (d)

Parameter d, setting 00 = 10 sec; 99 = continuous and adjustable between 01 and 15 = number of minutes.

Continuous water circulation is advisable if there is a danger of the heating system freezing up.

13.2.8 ΔT from control stop point to start point (E)

Parameter E, adjustable from 5 to 20°C.

This value sets the flow temperature at which the boiler will cut back in after a control stop.

The boiler will always go to a control stop when the flow temperature equals the flow setpoint temperature + 5°C. The ΔT defines when the burner is switched on again.

A value of 10°C indicates that the temperature has to drop 5°C below the calculated flow temperature set point before the boiler starts to run again.

Cut back in temperature = flow setpoint (80) + 5 - parameter E (10), i.e. 80 + 5 - 10 = 75°C.

13.2.9 Maximum flue gas temperature (F)

Parameter F, adjustable between 80 and 120°C.

This value sets the maximum operating flue gas temperature - for use with PVC flue systems.

13.2.10 High limit temperature setting (G)

Parameter G, adjustable between 90 and 110°C.

This value sets the high limit temperature at which the boiler will shutdown in a lockout condition requiring manual intervention.

! Important!! If the factory setting is reduced, a corresponding reduction in flow setpoint will be required otherwise the min flow rate may be effected.

13.2.11 Modulation start point at ΔT (H)

Parameter H, adjustable between 10 and 30°C.

This value sets the flow/ return ΔT point at which the control modulation begins. The boiler starts to modulate at the setpoint and will be at minimum output if the ΔT continues to rise to 40°C. At 45°C the boiler will shut (shut-off code b 30). For installations with low flow rates the starting point modulation can be brought forward (i.e. 15°C), closer matching boiler output to system demand. In systems with small volume flows the modulation start point can be brought forward. The boiler is better equipped to anticipate low heat demand.

The factory setpoint should be correct for most installations. The start point should only be changed if absolutely necessary.

13.2.12 Minimum water pressure (I₁)

Parameter I₁, adjustable between 0 and 6 bar.

This setting only applies if an optional hydraulic pressure sensor has been connected.

This value sets the point at which the boiler will shut-down if the system pressure falls below it. The boiler will resume normal operation when pressure is restored.

13.2.13 Adjustments options/ accessories (I₂)

Parameter I₂, adjustable between 0 and 15.

This setting is only applicable if options from table 21 are connected to the boiler. The control unit detects which options have been connected by means of the value of this parameter and adjusts the boiler control on this basis.

The required feedback message (as output in % or as temperature in °C) can also be selected here if the (standard) analog output is used. A list of values that have been assigned to specific options can be found in table 21. Adding together the values of the options used gives the parameter I₂.

Options	Value	Sum
Hydraulic pressure sensor	1	
Analog output:		
Heat output (%)	0	
Temperature (°C)	4	
Gas leakage control VPS	8	
Parameter I ₂ :		...

table 21 Adjustments options/accessories

Examples:

- Factory setting is 0: the analog output will be in %.
- Water pressure sensor (1) and valve leak proving system (8) options are connected: parameter I₂ is set to (1) + (8) = 09.

13.2.14 “Low” speed with H/L control (L₁)

Parameter L₁, adjustable between 10 and 60 (x 100) rpm.

This setting only applies if the boiler is in High/Low control mode (parameter R₁ = 21).

13.2.15 Boiler type (P₁)

This code appears only when replacing the control unit. After placing the new control unit, code P₁05 appears automatically in the display. The value 05 must be changed in to the correct value for your boiler type (see mounting-instructions of the service unit).

14 FAULT-FINDING

14.1 General

If the boiler does not start up, check the following:

- Is a 230 V supply present;
- Is there a heat demand;
- Has the boiler control (parameter \boxed{A}) been set correctly (see section 13.1.3).

If the above items have been verified and the boiler does not start, this indicates a failure.

In the case of a failure signal, both the **code** window and the ⓘ window will flash. Except for failure $\boxed{F}\boxed{0}\boxed{3}$ (does not flash).

Important!!

Keep a record of the failure code before resetting (numbers, including flashing ones and dots) and quote it when asking for support. The failure code is needed to find the cause of the fault quickly and correctly. For further details on the various failure codes and possible causes refer to table 23.

 Apart from failure codes (lock-out), the system also knows shut-off codes (see section 12.4). In the latter case only the two dots in the ⓘ window will flash and the **code** window will display $\boxed{.}$. A shut-off code may refer to a system problem or incorrect setting.

14.2 Failure mode ($\boxed{!}$ $\boxed{.}$ $\boxed{.}$) (service level)

The latest failure and corresponding operating codes and applicable temperatures are stored in the micro-processor memory and can be read out in failure mode as follows:

- Enter the service code $\boxed{L}\boxed{!}\boxed{2}$ (see section 13.2).
- Press the ⬆ key until $\boxed{!}$ appears in the code window (digit flashes).
- Select the required step with the ▶▶▶ key.

Code	ⓘ	Description
$\boxed{!}$	$\boxed{3}\boxed{7}$	Failure code (see table 23)
$\boxed{2}$	$\boxed{0}\boxed{3}$	Operating code, with failure intervention (section 12.1)
$\boxed{3}$	$\boxed{5}\boxed{3}$	Flow temperature, with failure intervention
$\boxed{4}$	$\boxed{4}\boxed{0}$	Return temperature, with failure intervention
$\boxed{5}$	$\boxed{5}\boxed{8}$	Flue gas temperature, with failure intervention
$\boxed{6}$	$\boxed{6}\boxed{3}$	Boiler block temperature
$\boxed{7} + \boxed{8}$	$\boxed{0}\boxed{0}$	Time from failure (with PC software only)
$\boxed{9}$	$\boxed{1}\boxed{8}$	Ionisation level (analog)

\boxed{a}	$\boxed{1}\boxed{1}$	Operating hours (hundred thousands and ten thousands)
\boxed{b}	$\boxed{8}\boxed{0}$	Operating hours (thousands and hundreds)
\boxed{c}	$\boxed{2}\boxed{6}$	Operating hours (tens and units)
\boxed{d}	$\boxed{2}\boxed{6}$	Fan speed at failure (thousands and hundreds)
\boxed{e}	$\boxed{6}\boxed{7}$	Fan speed at failure (tens and units)

table 22 Service level failure mode

In the above example:

The return temperature sensor is defective (= failure code $\boxed{3}\boxed{7}$), during burning (= operating code $\boxed{0}\boxed{3}$) with a flow temperature of 53°C, return temperature of 40°C and a flue gas temperature of 58°C.

The boiler block temperature was 63 °C, the ionisation level was 1.8 µA, the boiler had 118026 operating hours and a speed of 2667 rpm.

The time elapsed after the failure can only be read on a PC or laptop.

14.3 Cooling mode

This mode enables maintenance on the burner and/ or the heat exchanger to be carried out more efficiently. In this mode, the fan runs at maximum speed for two minutes, which cools down the boiler rapidly. When this mode is active, the system does not respond to heat demands.

 **Important!!** This mode can only be activated if there is no heat demand on the boiler.

The code $\boxed{L}\boxed{.}\boxed{L}$ indicates that the mode is active ($\boxed{L}\boxed{.}\boxed{L}$ for cooling).

The mode is activated by pressing the ▶▶▶ and [+] keys simultaneously (during normal operating status with no heat demand).

The mode can be terminated prematurely by pressing the [+] and [-] keys simultaneously.

14.4 Summary of failures (lock-out)

In the case of the following failures, note the dots in between the numbers ($\boxed{0}\boxed{.}\boxed{0} = 100$, $\boxed{0}\boxed{.}\boxed{1} = 101$ and $\boxed{0}\boxed{.}\boxed{2} = 102$, see section 11.3).

Failure	Description	Cause/check points
00	Flame simulation, (flame detected when control is in the off position)	<ul style="list-style-type: none"> - Burner glows as a result of a high CO₂ percentage. - Check the combined ignition/ionisation electrode (gap should be 3 to 4 mm apart). - Gas valve multiblock is leaking or is stuck in the open position. Check and replace valve.
01	Short circuit in 24V circuit	Check: <ul style="list-style-type: none"> - Wiring to sensors - Wiring to gas valve multiblock.
02	No flame or ionisation (after 5 start attempts)	a. No ignition spark. Check: <ul style="list-style-type: none"> - Connection of ignition cable and spark plug cover - Ignition cable and electrode for 'breakdown' - For 'flash over' between spark plug cover and earth - Electrode distance, should be 3 to 4 mm between pins - Condition of burner set (burner set/ electrode seal) - Earth. b. Ignition spark present, but no flame. Check the following: <ul style="list-style-type: none"> - The gas cock is open - There is sufficient inlet gas pressure (20 - 30 mbar) - The gas pipe has been bled - The gas valve multiblock is energised during ignition and actually opens - The electrode is clean and fitted correctly - The gas pipe is not blocked/ fitted incorrectly - The air supply or flue gas discharge is not blocked/fitted incorrectly - The gas/ air mixture is set correctly. c. There is a flame, but there is insufficient ionisation (< 2 µA). Check: <ul style="list-style-type: none"> - The condition of the electrode and earth - The temperature sensors for leakage current
03	Gas valve multiblock defective	Control unit does not recognise gas valve multiblock. Check the following: <ul style="list-style-type: none"> - The wiring on the gas valve multiblock has been connected (correctly) - The gas valve multiblock is not defective (burnt out/ short-circuit).
F03 (does not flash)	Fuse 3 defective	Replace fuse 3
04	Permanently locked out	Mains voltage has been disconnected during lock-out. Solution: reset (original lock-out usually returns automatically).
05	No processor handshake (or external influences)	Fault in control unit or fault due to EMC influences Reset first, if fault persists replace control unit. If fault still persists, locate and remove possible external EMC sources.
06	Input failure; sensors are short circuiting	Check the wiring of the temperature sensors. If fault persists, replace control unit. If fault still persists, locate and remove possible EMC sources.
07	Gas valve multiblock relay fault	Gas valve multiblock defective or not connected
08	Air pressure differential sensor does not maintain check level	Check: <ul style="list-style-type: none"> - The air supply or flue gas discharge for blockages/ installation faults - The air pressure differential switch and connections.
11	Fault on internal communication bus (I ² C-bus) when reading EPROM	Check: <ul style="list-style-type: none"> - The multiple wire cable in the instrument panel for short circuit - For moisture on the display - Find and remove any EMC sources.

Remeha Gas 310 ECO

12	Locked input open	<ul style="list-style-type: none"> - Maximum thermostat (= external protection), connected to terminals X29-1 and X29-2 on the terminal strip, has tripped or wire bridge has been removed - Fuse F3 on automatic burner unit is defective.
17	Gas valve multiblock protection	Gas valve multiblock defective or not connected
18	Flow temperature too high	Check: <ul style="list-style-type: none"> - Flow - System has been correctly bled - Temperature sensors for deviations - Water pressure in the system.
20	Excessive fan speed	Check: <ul style="list-style-type: none"> - Parameters - Whether fan cable is defective or making poor contact. If failure persists, fan or control unit may be defective.
28	Fan not operating	<ul style="list-style-type: none"> - Fan defective - Fan cable or connector is corroded, resulting in absence of voltage or control signal.
29	Fan keeps running or signal is incorrect	<ul style="list-style-type: none"> - Check the fan cable connectors on both the fan and the automatic burner unit side - Fan electronics defective - High natural draught.
30	Max. ΔT exceeded	Check: <ul style="list-style-type: none"> - Flow - System has been correctly bled - Water pressure in the system.
31	Temperature sensor fault	Short circuit of flow temperature sensor.
32	Temperature sensor fault	Short circuit of return temperature sensor.
35	Temperature sensor fault	Short circuit of flue gas temperature sensor.
36	Temperature sensor fault	Flow temperature sensor not connected or defective.
37	Temperature sensor fault	Return temperature sensor not connected or defective.
38	Air pressure differential sensor short circuited	<ul style="list-style-type: none"> - Check the connecting cable of the air pressure differential sensor - The air pressure differential sensor is defective or not connected
39	Air pressure differential sensor open	<ul style="list-style-type: none"> - Check the air pressure differential sensor connecting cable for short-circuiting, etc. - Air pressure differential sensor is defective
40	Temperature sensor fault	Flue gas temperature sensor not connected or defective.
43	One or more parameters are out of limits	The input of the parameter (s) is incorrect.
45	Hydraulic pressure sensor short circuited	<ul style="list-style-type: none"> - Check the hydraulic pressure sensor connecting cable for short circuit etc. - Hydraulic pressure sensor is defective
46	Hydraulic pressure sensor open	<ul style="list-style-type: none"> - Check the connecting cable of the hydraulic pressure sensor - The hydraulic pressure sensor is defective or not connected
52	Maximum flue gas temperature exceeded	Check the heat exchanger for fouling on the flue gas side.
61	Air pressure differential sensor not opening	Air pressure differential sensor not opening. Check the following: <ul style="list-style-type: none"> - Is the air pressure differential switch defective - Has the wiring short circuited - Check for signs of external thermal draught in the flue gas discharge duct.
77	Lack of ionisation during operation (after 4 restarts during 1 heat demand)	<ul style="list-style-type: none"> - Flue gas recirculation. Check flue gas discharge system for installation faults and heat exchanger for possible leaks - Insufficient air flow due to blockage - Check the boiler settings.

83	Boiler block temperature too high	Check: <ul style="list-style-type: none"> - The heating pump is running - There is sufficient water flow through the boiler - The water pressure is > 0.8 bar.
89	Gas leak VA1 (optional)	The VPS gas leakage control unit has detected a leak. Check for external leaks, otherwise replace gas valve multiblock.
90	Gas leak VA2 (optional)	The VPS gas leakage control unit has detected a leak. Check for external leaks, otherwise replace gas valve multiblock.
91	Air pressure differential sensor fault	Air pressure differential sensor fault during pre-ventilation (after 4 restarts). Check the following: <ul style="list-style-type: none"> - Is the air pressure differential switch defective - Has the wiring short circuited - Check for signs of external thermal draught in the flue gas discharge duct.
94	Boiler block temperature > flow temperature + hysteresis	Check: <ul style="list-style-type: none"> - The heating pump is operating - There is sufficient water flow through the boiler - The water pressure is > 0.8 bar.
95	Temperature sensor fault	Short circuit of boiler block sensor.
96	Temperature sensor fault	Boiler shut-off sensor not connected or defective.
97	Boiler block temperature too high	Check: <ul style="list-style-type: none"> - The heating pump is operating - There is sufficient water flow through the boiler - The water pressure is > 0.8 bar.
Other codes	Control unit fault	Proceed as follows with all non-listed codes: <ul style="list-style-type: none"> - Press reset once - Check that the wiring is not short circuited - If the fault persists, contact our Service Department.

table 23 Failure codes

15 INSPECTION AND MAINTENANCE INSTRUCTIONS

15.1 General

The Remeha Gas 310 ECO has been designed to need minimum maintenance, but to ensure optimum efficiency we advise that once a year the boiler should be checked and if necessary cleaned and reset.

All service and maintenance must be carried out by a qualified Engineer with the relevant training and certification (ie CORGI - ACOPS - etc.).

15.2 Cooling mode

This mode enables maintenance on the burner and/ or the heat exchanger to be carried out more efficiently. In this mode, the fann runs at maximum speed for two minutes, which cools down the boiler rapidly. When this mode is active, the system does not respond to heat demands.

⚠ Important!! This mode can only be activated if there is no heat demand on the boiler. The code $\square\square\square$ indicates that the mode is active ($\square\square\square$ for cooling).

The mode is activated by pressing the $\triangleright\triangleright\triangleright$ and $[+]$ keys simultaneously (during normal operating status with no heat demand).

The mode can be terminated prematurely by pressing the $[+]$ and $[-]$ keys simultaneously.

15.3 Annual Inspection

The annual inspection of the Remeha Gas 310 as follows:

- Check combustion characteristics, full and part load (see section 10.1).
- Note:** When checking combustion the CO₂ levels should be in accordance with the values in table 11 with a tolerance of +/- 0.5%. If the levels are outside these tolerances, adjustment to the levels must be made in accordance with a tolerance of +/- 0.15%.
- Check flue gas temperature. If flue gas temperature is more than 30°C above the boiler return water temperature the heat exchanger must be cleaned (see par. 15.4.5).
- Check/clean the condensate siphon (refill with clean water).
- Check for leaks (waterside, flue gas side and gas soundness).
- Check flue and air inlet system is clear and gas/water tight.
- Check system pressure.
- Check control settings.
- Check boiler parameters.
- Check ionisation level, minimum 3 µA dc (see 12.2, parameter \square).

If ionisation level < 3 µA dc or not present, check:

- Is flame shape stable and colour as described in commissioning instructions.

- Check ignition probe earth.
- Check condition of ignition/ ionisation probe replace if necessary.
- Replace electrode at least every 2 years.
- Clean any oxides/deposits with sandpaper or fine emery cloth.
- Check shape of probe and ignition gap, i.e. 3 to 4 mm (see fig. 36).
- Check temperature sensors for resistance values against fig. 28 (humidity on sensors).
- Check and clean if necessary the gas filter (see section 15.4.10).
- Check air box and dirt trap (see section 15.4.1).

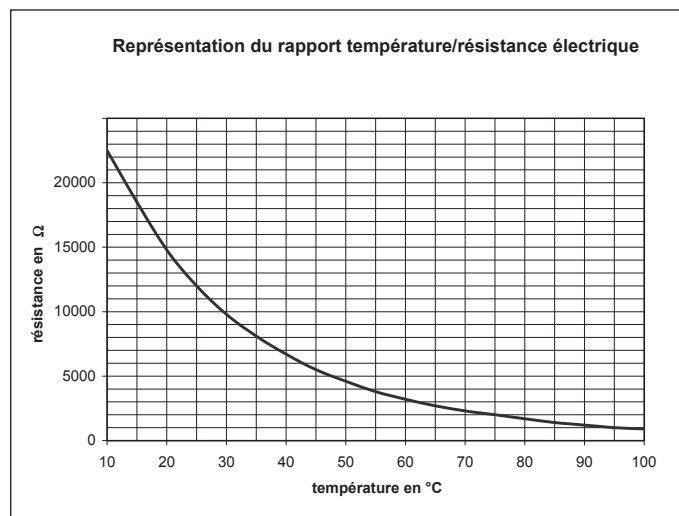

fig. 28 Sensor resistance graph

15.4 Maintenance

If during the annual inspection combustion results indicate that the boiler is no longer operating at the optimum level, additional maintenance should be carried out as follows:

NOTE:

Please ensure that the gas supply and mains power supply is isolated before any maintenance work is carried out on the boiler.

Care should be taken when stripping the boiler for maintenance making sure that all parts nuts, washers and gaskets etc. are kept safe, clean and dry for re-assembly. Following maintenance/ cleaning, the boiler should be re-assembled in the reverse order re-placing gaskets and joints where found necessary.

All general cleaning should be carried out with compressed air, a soft brush or damp cloth to avoid damaging components. (Solvents must not be used).

Remove front and end casing panels – lift casing panel slightly upwards and tilt toward you lift again clear of the bottom rail.

15.4.1 Inspection of air box and dirt trap

The air box has a dirt trap on the inlet side. Check this for dirt, leaves, etc. If the boiler is closed, the clamping strip under the casing must be removed first, check using a mirror if necessary.

There is an inspection glass on the air box on the fan side. Check the air box for dirt using a lamp. If the air box is dirty, it must be dismantled and blown clean. If the air box is dirty, the following components must also be dismantled and blown clean:

- non return valve
- venturi
- fan

! Important!! Ensure that the balancing clips in the impeller stay in place!

- burner

! Important!! The sealing between the burner and the mixing bend may be sticky. Prevent the sealing from tearing. Damaged or hardened sealing must always be replaced.

- mixing bend

15.4.2 Cleaning the non return valve

Use compressed air or a synthetic brush to clean the non return valve

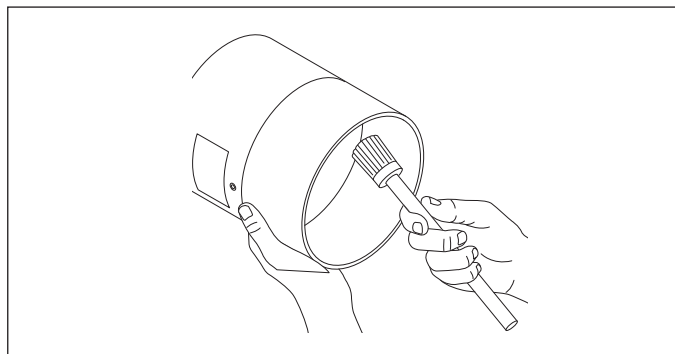

fig. 29 non return valve being cleaned with soft brush

15.4.3 Cleaning the venturi

Use compressed air or a synthetic brush to clean venturi – Make sure that the silicon hose between gas valve and venturi is clear and in good condition.

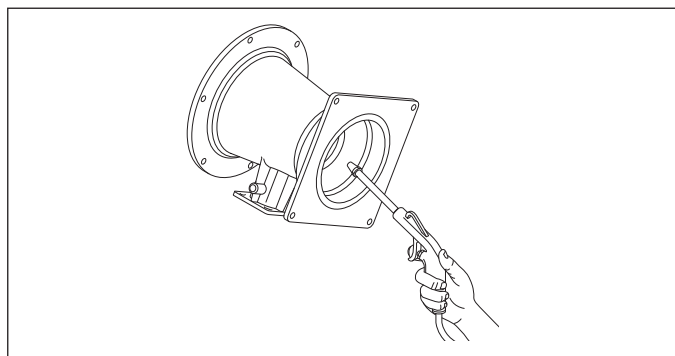

fig. 30 venturi being cleaned with compressed air

15.4.4 Cleaning the fan

Use compressed air or a synthetic brush to clean fan, **be careful not to disturb the balance clips on the vanes**

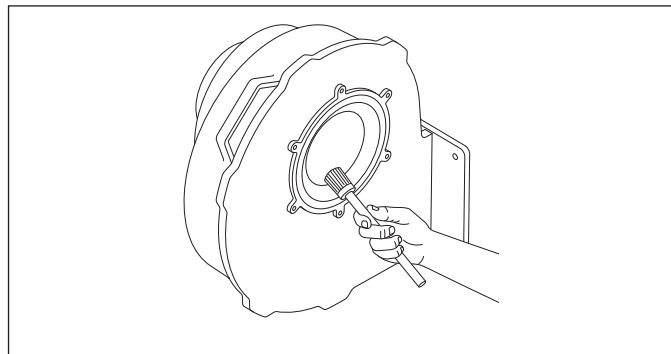

fig. 31 fan being cleaned with soft brush

15.4.5 Cleaning the heat exchanger

Release the retaining nuts from heat exchanger cover plate, remove plate, be careful not to damage the gasket, store safely.

Heat exchanger can be washed with clean water, if badly contaminated, clean with a small stiff bristle “bottle type” brush or use the special cleaning tool (supplied optional). Care should be taken when using water in the confined space of the boiler casing to avoid contaminating the electrical controls. Compressed air can also be used but care should be taken to ensure disturbed dust etc does not contaminate the rest of boiler and controls. Replace the heat exchanger front plate after the cleaning and tighten the retaining nuts.

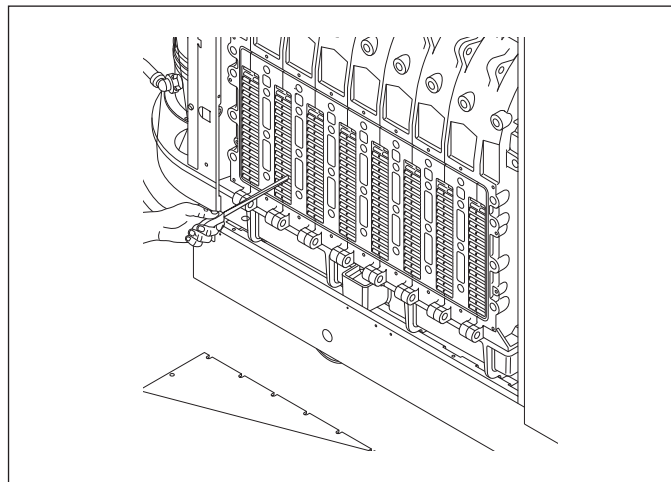

fig. 32 heat exchanger opened up for cleaning

Remeha Gas 310 ECO

15.4.6 Cleaning the burner assembly

Clean the burner assembly by using compressed air only - between 2 and 5 bar with the nozzle positioned a min of 10mm away and towards the face of the burner. Check that the retaining bolts are tight. If the burner is removed from the front plate ensure burner-retaining screws are tight on re-assembly.

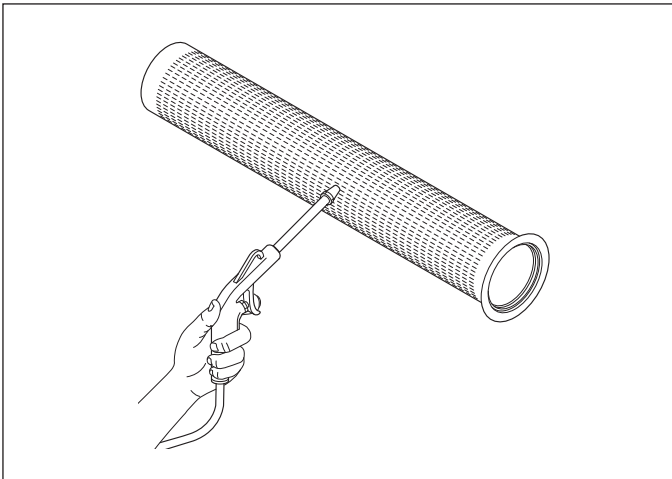

fig. 33 burner attached to plate with air nozzle cleaning the surface

15.4.7 Cleaning the condensate collector

Clean the condensate collector by removing the inspection cover (next to the flue gas discharge) and then rinsing the collector with water.

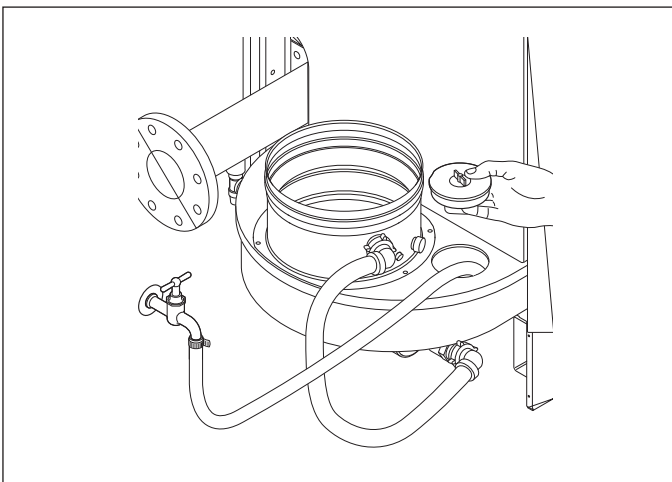

fig. 34 condensate collector inspection cover

15.4.8 Cleaning the syphon

Remove the complete syphon (located underneath condensate collector beneath the flue connection) Remove syphon, clean and refill with clean water and re-fit.

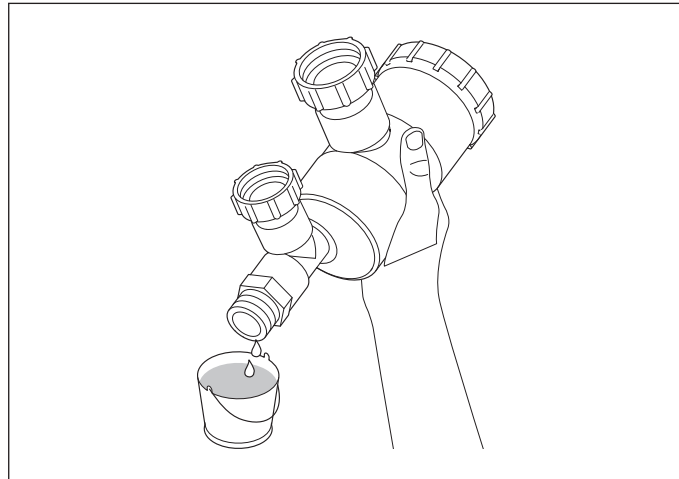

fig. 35 syphon being emptied

15.4.9 Cleaning/Replacing the Ignition/Ionisation electrode

Remove safety bracket from the heat exchanger then remove the two retaining screws on the electrode assembly, remove assembly and examine for wear and dirt, clean and re-gap electrode (3mm) re-fit if in good condition (replace gasket if necessary). Replace electrode assembly if necessary - then discard screws and gasket and fit replacement assembly c/w new gasket and screws making sure that the earth connection is in good condition and in contact with the base plate. Re-fit safety bracket.

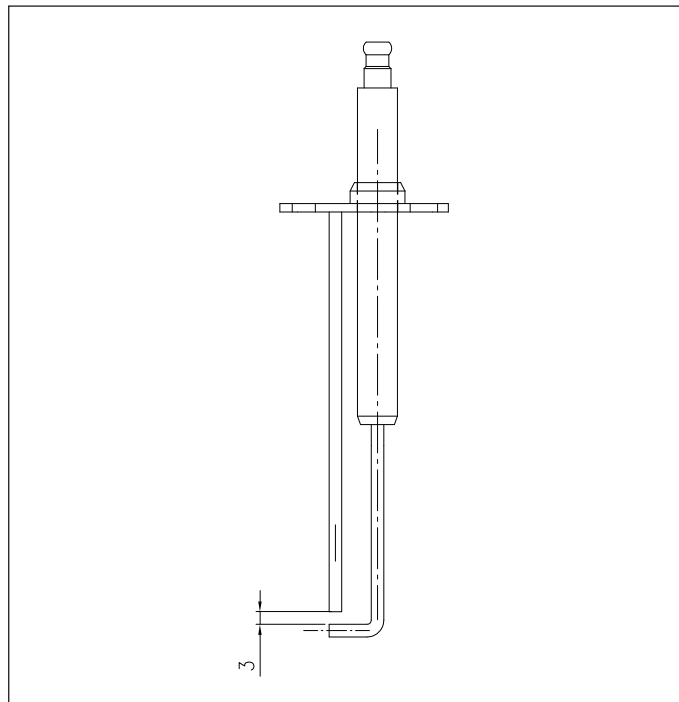

fig. 36 ignition electrode

00.31H.79.00013

15.4.10 Gas filter check

Measure pressure differential ΔP at measuring points P_i and P_u (see *fig. 37*) on the gas filter.

- If the ΔP value is above 10 mbar: gas filter must be replaced.
- If the ΔP value is between 6 and 10 mbar: measure outgoing pressure on P_u . If this value is below 18 mbar: gas filter must be replaced.
- If the ΔP value is below 6 mbar: OK.

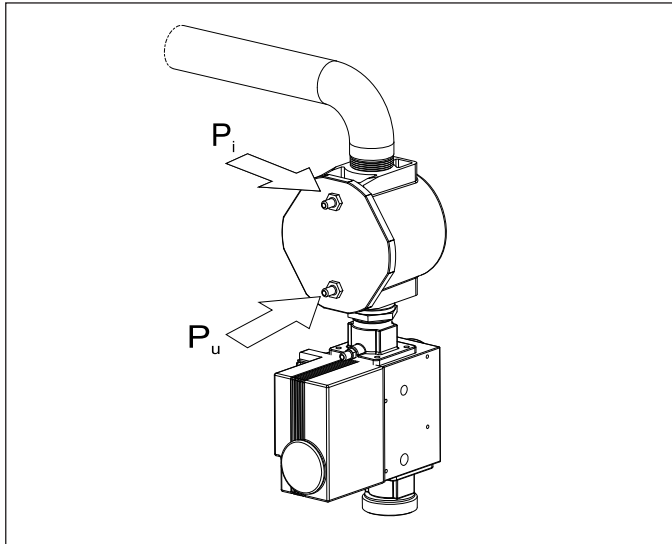

fig. 37 gas filter with measuring points

15.4.11 Cleaning the inspection glass

Remove the two retaining screws on the inspection glass holder, clean and replace.

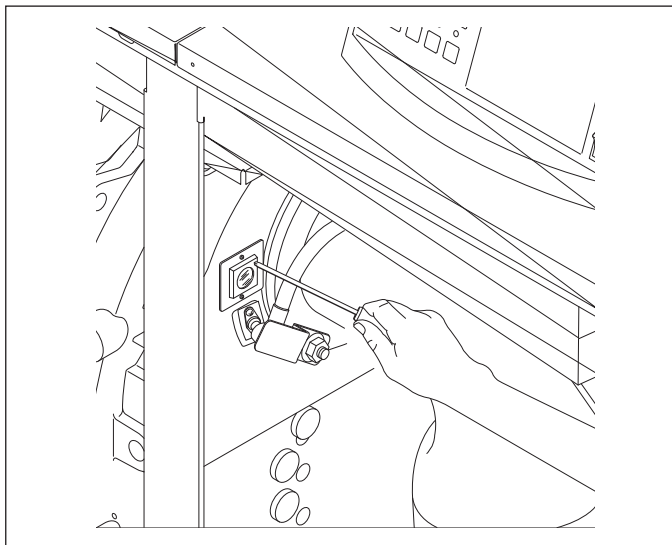

fig. 38 inspection glass removal

Re-assemble boiler in reverse order, check front plate gasket and insulation piece, replace if required. Also check the gasket on fan and on gas valve, replace if necessary. Ensure that all cables are routed correctly using existing clips and ties were possible to ensure that they do not touch any hot parts of the boiler.

! Important!! Ensure that wires do not come into contact with hot boiler parts

Commission boiler in accordance with *section 10.1*; complete site report and/or boiler log book if present.

Remeha Gas 310 ECO

15.5 Exploded view and spare parts list

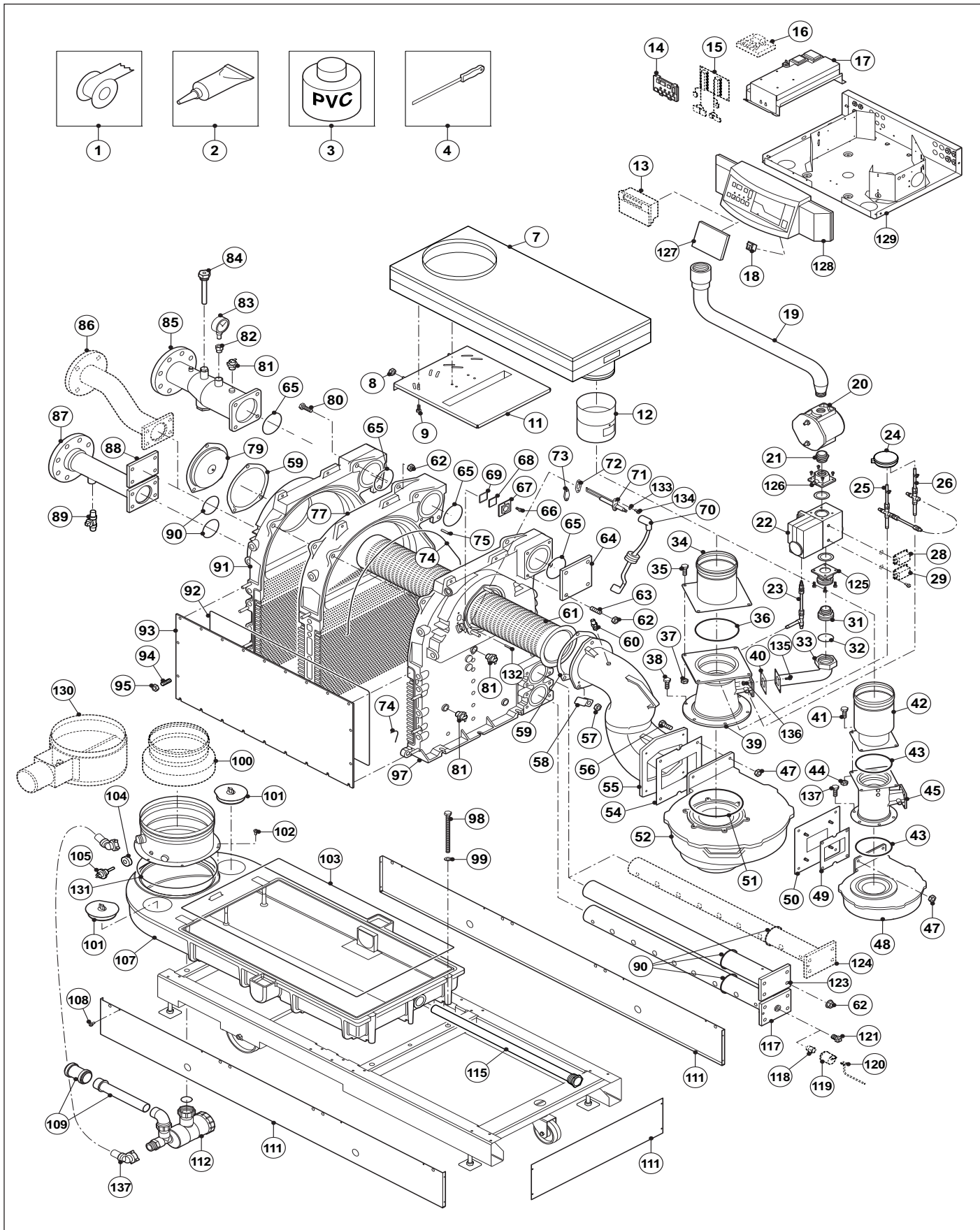

fig. 39 Exploded view

Pos. nr.	Part description	Pos. nr.	Part description
1	Teflon tape	51	O-ring Ø 183
2	Loctite	52	Fan (for 7, 8, 9 sections)
3	PVC glue	53	Nut M8
4	Cleaning tool	54	Sealing plate fan/ mixing elbow (for 7, 8, 9 sections)
		55	Mixing elbow
		56	Bolt M8 x 30
7	Air box	57	Nut M12
8	Nut M8	58	Protection bracket
9	Bolt M6 x 16	59	Sealing plate
		60	Measuring nipple
11	Air box support	61	Burner
12	Flue gas damper	62	Nut M12
13	Controller (option)	63	Stud bolt M12 x 35
14	Printed circuit display	64	Blind flange flow
15	Adapter (for pos. 13)	65	O-ring Ø 107
16	Interface (for pos. 13)	66	Bolt M4 x 8
17	Printed circuit control unit	67	Inspection glass holder
18	On/off switch	68	Sealing inspection glass holder
19	Gas supply pipe	69	Inspection glass
20	Gas filter	70	Ignition cable
21	Reducing nipple	71	Ignition electrode
22	Gas valve multiblock	72	Sealing ignition electrode
23	Pressure compensation measurement tube	73	Cover plate ignition electrode
24	Air pressure sensor	74	Silicone sealant
25	Air measurement tube	75	Locking pin Ø 12
26	Gas measurement tube		
		77	Intermediate section
28	Gas valve leak control system (option)	78	Sealing plate
29	Minimum gas pressure control (option)	79	Cover plate burner entry
		80	Bolt M12 x 40
31	Screw nipple	81	Temperature sensor
32	Gasket ring Ø 56 x Ø 42 x2	82	Air valve tube
33	Gas supply elbow	83	Pressure gauge
34	Venturi connecting piece (for 7, 8, 9 sections)	84	Thermostat pocket Ø 7
35	Bolt M8 x 16	85	Flow tube
36	O-ring Ø 142 (for 7, 8, 9 sections)	86	Second return water distribution pipe
37	Nut M8	87	Return water distribution pipe
38	Bolt M8 x 16	88	Blind flange return
39	Venturi (for 7, 8, 9 sections)	89	Filling and drain cock
40	Sealing plate venturi	90	O-ring Ø 82
41	Bolt M5 x 20	91	End section left
42	Venturi connecting piece (for 5 and 6 sections)	92	Sealing cable Ø 10
43	O-ring Ø 110 (for 5 and 6 sections)	93	Frontplate heatexchanger
44	Nut M5	94	Stud bolt M8 x 10
45	Venturi (for 5 and 6 sections)	95	Nut M8
47	Nut M8	97	End section right
48	Fan (for 5 and 6 sections)	98	Bolt M12 x 180
49	Sealing plate fan/ mixing elbow (for 5 and 6 sections)	99	Washer
50	Mounting plate fan (for 5 and 6 sections)	100	Flue gas adapter

Remeha Gas 310 ECO

Pos. nr.	Part description	Pos. nr.	Part description
101	Inspection cover	121	Plug 3/8"
102	Bolt M6 x 16		
103	Sealing cable Ø 10	123	Return blind pipe
104	Flue gas sensor jacket	124	Second return distribution pipe
		125	Straight connecting flange
105	Flue gas sensor	126	Straight connecting flange
		127	Cover plate controller
107	Condensate collector	128	Front panel
108	Sheet-metal screw 4,2 x 9,5	129	Front panel support
109	Adapter Ø 32 / 40		
111	Plinth set (side and front)	132	Davel Ø 4 x 14
112	Siphon	133	Toothed spring ring
		134	Bolt M4 x 8
		135	Nut M5
115	Lambda pipe (for 5 sections only)	136	Boltt M5 x 20
		137	Bolt M8 x 16
117	Return distribution pipe		
118	Water seal (for pos. 119)		
119	Hydraulic pressure sensor (option)		
120	Cable bundle (for pos. 119)		

table 24 Part list

16 APPENDICES

16.1 Control menu

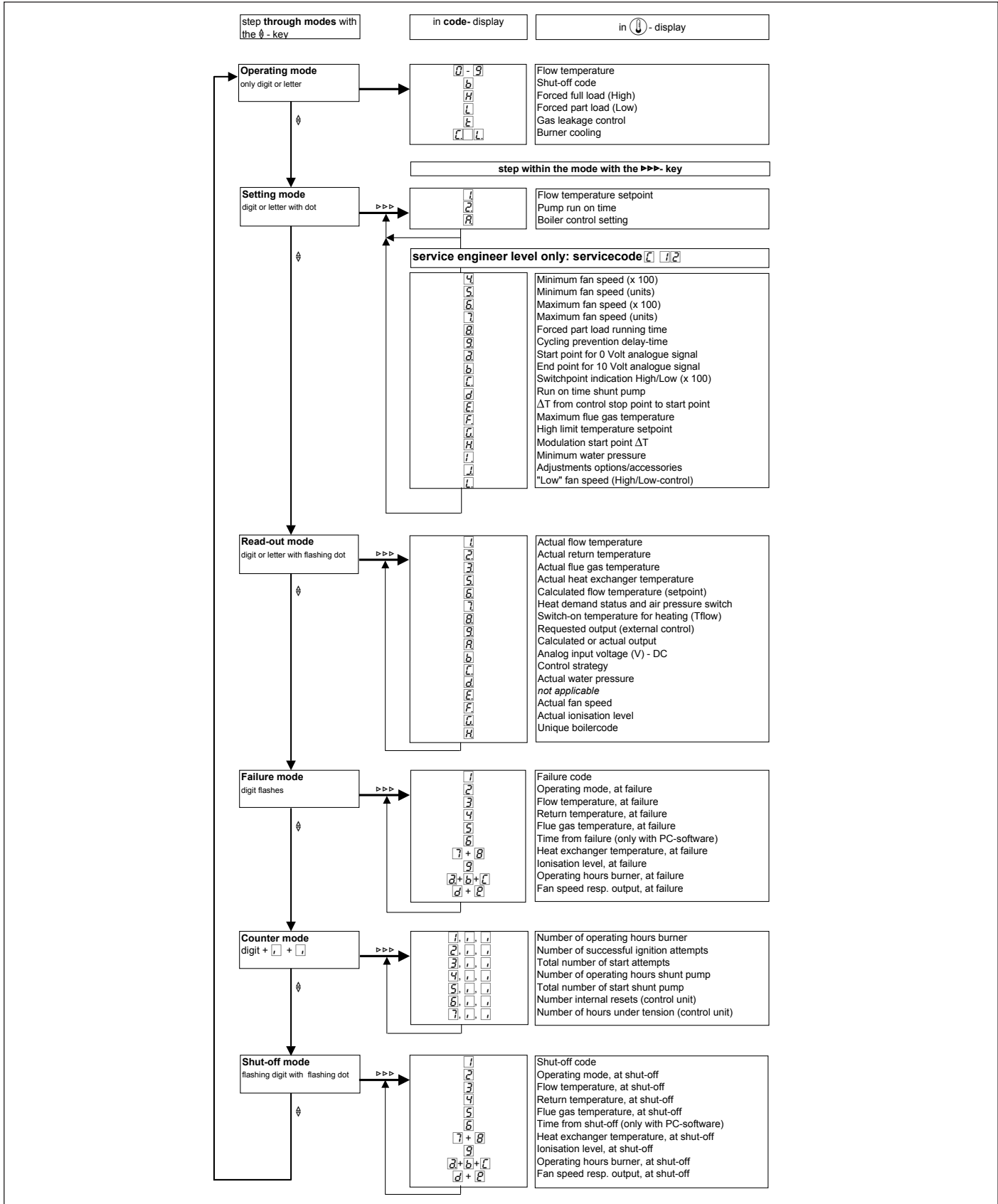

fig. 40 Control menu flow chart

Remeha Gas 310 ECO

16.2 Shut-off codes

Code	Description	Cause/Check
b 08	Insufficient air transport during pre-ventilation. The boiler is locked after 5 restarts (6 starts) with code 08 (see section 14.4).	<ul style="list-style-type: none"> - Air supply or flue gas discharge for blockages/ installation faults - Air pressure differential switch and connections.
b 24	T_{return} is higher than $T_{\text{flow}} + 2^{\circ}\text{C}$ (e.g. 93°C if T_{return} is 90°C) for more than 10 minutes (and the boiler has been running at minimum load for 10 minutes). The shut-off is lifted when T_{return} is less than or equal to $T_{\text{flow}} + 3^{\circ}\text{C}$, e.g. 92°C .	<ul style="list-style-type: none"> - Flow and return sensors have been swapped - Flow and return pipes have been swapped.
b 25	Maximum acceptable ascension speed of the boiler block temperature has been exceeded. The boiler shuts down for 10 minutes, after 5 consecutive start attempts within one heat demand command the shut-off is recorded in the failure register as a fault, the boiler does not lock out/go into failure mode.	<ul style="list-style-type: none"> - Whether heating pump is running - The water flow through the boiler - Water pressure.
b 26	If minimum gas pressure switch LD is connected (optional): minimum gas pressure undershot. The shut-off is lifted when the gas pressure returns.	<ul style="list-style-type: none"> - Gas supply (is gas valve open?) - Is switch set correctly? - Wiring.
b 28	Fan not running	<ul style="list-style-type: none"> - Fan defective - Fan cable or connector is corroded, resulting in absence of voltage or control signal
b 29	Fan continues to run or signal incorrect	<ul style="list-style-type: none"> - Check the fan cable connectors on both the fan side and the automatic control unit side - Fan electronics defective - High natural draught
b 30	Maximum acceptable difference between flow and return temperature has been exceeded. The boiler shuts down for 150 seconds, after 20 consecutive start attempts within one heat demand command the shut-off is recorded in the failure register as a fault, the boiler does not lock out/go into failure mode.	<ul style="list-style-type: none"> - Whether the heating pump is operating - The water flow through the boiler - Water pressure
b 38	Air pressure differential sensor short circuited; after 4 restarts the shut-off goes into failure mode	<ul style="list-style-type: none"> - Check the connecting cable of the air pressure differential sensor - The air pressure differential sensor is defective or not connected
b 39	Air pressure differential sensor open; after 4 restarts the shut-off goes into failure mode	<ul style="list-style-type: none"> - Check the air pressure differential sensor connecting cable for short-circuiting, etc. - Air pressure differential sensor is defective
b 43	One or more parameters are out of limits.	The parameters in the memory of the control unit are incorrect.
b 45	Hydraulic pressure sensor short circuited	<ul style="list-style-type: none"> - Check the hydraulic pressure sensor connecting cable for short-circuiting, etc. - Hydraulic pressure sensor is defective
b 46	Hydraulic pressure sensor open	<ul style="list-style-type: none"> - Check the connecting cable of the hydraulic pressure sensor - The hydraulic pressure sensor is defective or not connected

b 52	Maximum flue gas temperature has been exceeded. The boiler shuts down for 150 seconds, followed by a restart. If the flue gas temperature rises 5°C above the maximum flue gas temperature, a lockout follows with code 52 (see section 14.4).	<ul style="list-style-type: none"> - The set maximum flue gas temperature - Boiler adjustment - Boiler for fouling.
b 61	Air pressure differential sensor not opening	<p>Air pressure differential sensor not opening Check the following:</p> <ul style="list-style-type: none"> - Is the air pressure differential switch defective - Has the wiring short circuited - Check for signs of external thermal draught in the flue gas discharge duct.
b 62	If hydraulic pressure sensor has been connected (optional): water pressure is too low. The control unit shuts down when the minimum water pressure is reached. The shut-off is lifted when the water pressure returns and the control unit returns to normal operating status.	<ul style="list-style-type: none"> - Refill boiler/system to the correct pressure - Sensor defective - Wiring defective - Hydraulic pressure sensor not connected but has been activated.
b 88	Shut-off input is open. When the input is closed, the shut-off is lifted.	Remove the cause of the shut-off.
b 94	Maximum acceptable difference between boiler shut-off temperature and flow temperature has been exceeded. The boiler shuts down for 10 minutes, after 5 consecutive start attempts within one heat demand command the shut-off is recorded in the failure register as a fault, the boiler does not go into failure mode.	<ul style="list-style-type: none"> - Flow - Pumps - Three-way valves
b 99	Boiler release contact is open.	<ul style="list-style-type: none"> - Boiler release contact on butterfly valve not made - Boiler release contact on terminal strip not connected (if boiler release contact is not used)

table 25 Shut-off codes



© **Copyright**

All technical and technological information contained in these technical instructions, as well as any drawings and technical descriptions furnished by us remain our property and may not be multiplied without our prior consent in writing.

62560-180609
AD

Subject to alterations



62560

Broag Ltd.

Remeha House

Molly Millars Lane

RG41 2QP WOKINGHAM, Berks.

Tel: +44 118 9783434

Fax: +44 118 9786977

Internet: uk.remeha.com

E-mail: boilers@broag-remeha.com

