

**British Gas** 

**Scottish Gas** 

600B742/01

## OWNER'S GUIDE

**Model BG C-1**

(GC No. 32-032-36)

***INSET LIVE FUEL  
EFFECT GAS FIRE***



(Manufacturer ref. BR657)



**THIS APPLIANCE IS FOR USE WITH NATURAL GAS (G20)  
WHEN CONVERTED USING CONVERSION KIT NO.591159 THIS  
APPLIANCE IS FOR USE WITH PROPANE GAS (G31)  
THIS APPLIANCE IS FOR USE IN THE UNITED KINGDOM (GB) AND  
THE REPUBLIC OF IRELAND (IE) ONLY.**

This guide is intended to help you care for your BG C-1 gas fire. Please read thoroughly before using and keep for future reference

**For Service Phone 0845 960 5040**

Manufactured exclusively for British Gas & Scottish Gas by  
Valor Heating, Wood Lane, Erdington, Birmingham B24 9QP

**This guide to be left with the owner**

# OWNER'S GUIDE

## LIST OF CONTENTS

<b>SAFETY</b> .....	<b>3</b>
<b>APPLIANCE DIMENSIONS</b> .....	<b>5</b>
<b>OPERATING YOUR FIRE</b> .....	<b>6</b>
The Oxysafe flame sensing & flue blockage safety system. ....	6
To light the fire.....	6
To turn the fire off.....	7
Lighting with a taper .....	7
<b>CLEANING</b> .....	<b>8</b>
Metal Parts.....	8
Coals and burner compartment walls.....	8
Ceramic burner .....	8
<b>FUEL BED REFITTING</b> .....	<b>9</b>
<b>MAINTENANCE</b> .....	<b>10</b>
Battery replacement.....	10
Regular maintenance .....	10
Servicing.....	11

---

This gas fire is designed to meet the most stringent quality, performance and safety requirements to provide you with many years' trouble-free service.

This guide aims to improve your understanding and appreciation of your BG C-1 gas fire by providing simple and informative instructions to ensure that you benefit from the excellent performance and features it has to offer.

# OWNER'S GUIDE

## SAFETY

### IF YOU SMELL GAS

**DON'T SMOKE**

**EXTINGUISH ALL NAKED FLAMES**

**DON'T TURN ELECTRICAL SWITCHES ON OR OFF**

**TURN OFF THE GAS SUPPLY AT THE METER**

**OPEN DOORS AND WINDOWS TO GET RID OF THE GAS**

**IMMEDIATELY CALL THE GAS EMERGENCY SERVICE - SEE YOUR LOCAL TELEPHONE DIRECTORY**

**Do** have the fire installed by a competent person. In the United Kingdom, installation must be in accordance with the latest edition of the Gas Safety (installation & use) Regulations. In the Republic of Ireland, installation must be in accordance with all national and local regulations in force.

**Do** have the chimney swept prior to installation if it was previously used for solid fuel.

**Do** have the fire installed in accordance with the installation instructions.

**Do** provide a minimum clearance as shown in graph 1 above the hearth to any shelf made of wood or other combustible material. Please bear this in mind if you are making any alterations to the room.

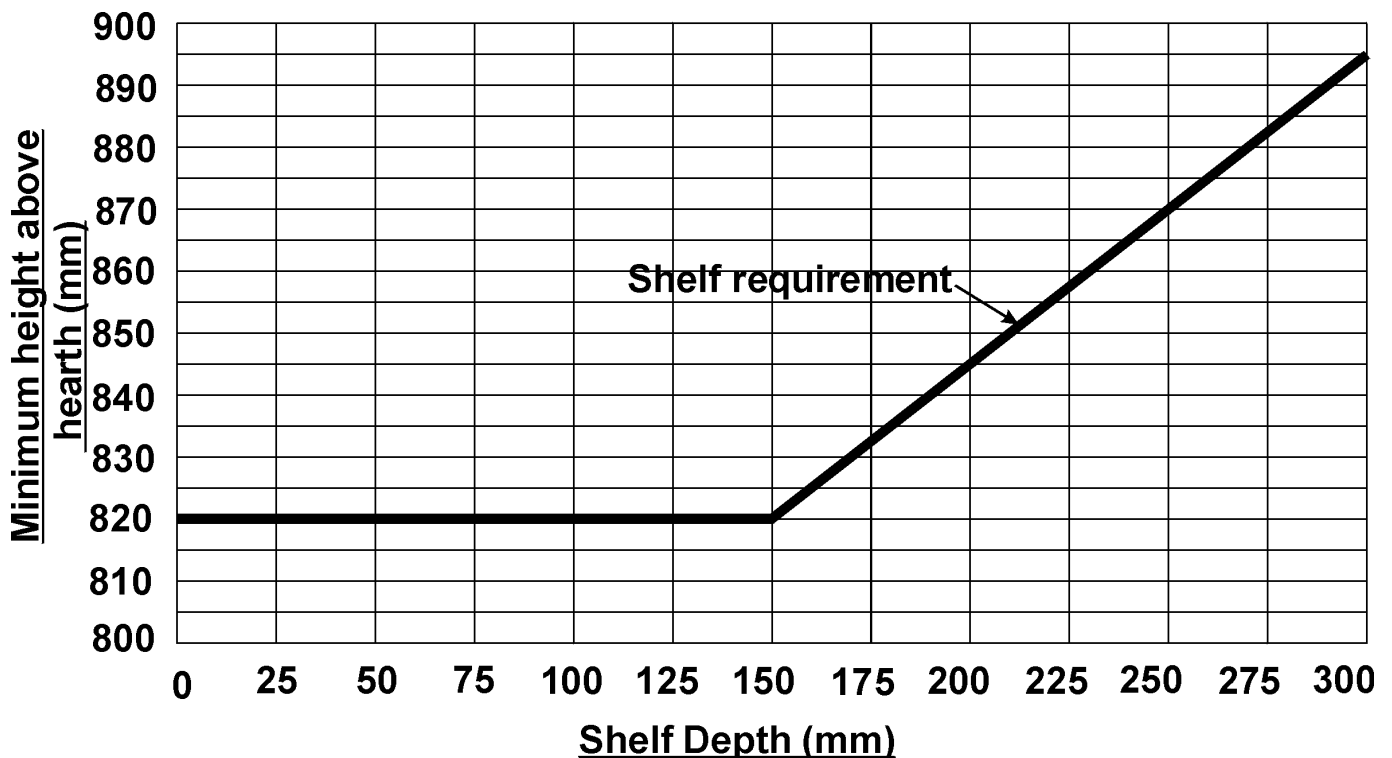

Graph 1 Combustible shelf clearances

# OWNER'S GUIDE

**Do** provide a suitable guard which complies with BS 6539 or 6778 for the protection of young children, the elderly and the infirm. Such a guard is also recommended for the protection of pet animals. (Although this fire conforms to all the applicable standards, it is a heating appliance and certain parts of its surface will become hot.)

**Do** wait three minutes before attempting to relight if the fire is switched off or the flames are extinguished for any reason. (Your fire is fitted with a safety device which will automatically shut off the gas supply to the fire if, for any reason, the flames go out.)

**Do** get advice about the suitability of any wall covering near your fire. Soft wall coverings (e.g. embossed vinyl, etc.) which have a raised pattern are easily affected by heat. They may, therefore, scorch or become discoloured when close to a heating appliance. Please bear this in mind whenever you are considering redecorating.

**Do** provide a minimum side clearance as detailed in figure 1. Please bear this in mind if ever you are considering altering the room.

**Don't** hang clothing, towels or any other fabrics over the fire.

**Don't** add any extra coals above the number stated in this guide. This could cause a safety hazard.

**Don't** put paper or any other material on the fire.

**Don't** place any combustible material (rugs, carpet, plastic tiles, etc.) on the hearth.

**Don't** attempt to clean or service the fire until it has been switched off and allowed to cool completely.

# OWNER'S GUIDE

## APPLIANCE DIMENSIONS

108mm minimum to combustible surface projecting beyond front of appliance (no clearance necessary to non-combustible surface)

108mm minimum mandatory clearance to combustible surface projecting beyond front of appliance and also recommended clearance to non-combustible surfaces for access

See Safety chapter and graph 1

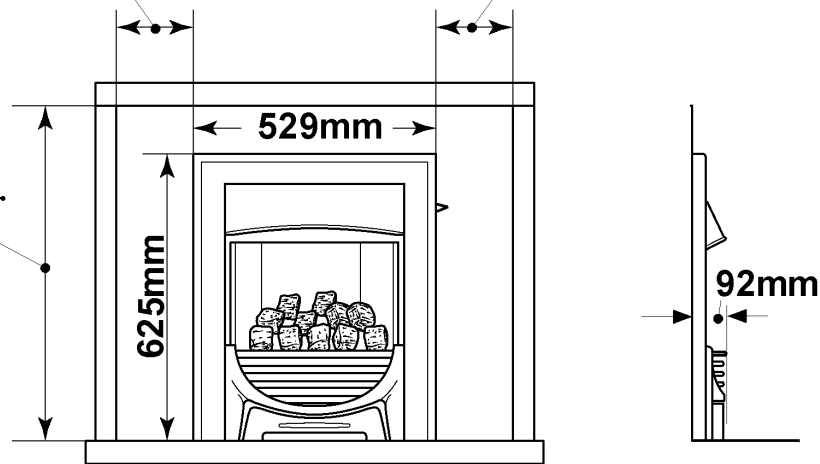

Fig. 1 Appliance dimensions

# OWNER'S GUIDE

## OPERATING YOUR FIRE

### *PLEASE NOTE*

When operating your fire for the first time, some vapours may be given off which may cause a slight odour and could possibly set off any smoke alarms in the immediate vicinity. These vapours are quite normal with new appliances. They are totally harmless and will disappear after a few hours use.

### **The Oxysafe flame sensing & flue blockage safety system.**

For your safety, this appliance is fitted with a flue blockage safety device which will shut down the appliance in the event of abnormal flue conditions. ***This device is NOT a substitute for an independently mounted Carbon Monoxide detector.***

The device will also automatically shut off the gas supply to the fire if the pilot flame goes out due to lack of oxygen or for any other reason.

***If this device starts to repeatedly shut off the gas, get expert advice.***

This device incorporates a probe which senses that the heat from the pilot flame is correct. If this probe is cool, the device will prevent any gas flow unless the control knob is held in at the ignition position.

If, for any reason, the flames go out when the fire is hot or if the fire is turned off when hot, always ***wait at least three minutes before attempting to relight.***

### **To light the fire**

The slide control is shown in figure 2.

1. Slide the control button to the bottom (ignition) position marked .

In this position, the electronic ignition system should cause a series of sparks which should light the pilot. Within four seconds of the pilot igniting, the main burner should light at its minimum setting.

If no sparks are produced to light the pilot, the battery may need replacing. Details of battery replacement are given further on in this manual.

Until you can obtain a replacement battery the fire can be lit with a taper as described later in the instructions.

2. Keep the button at the ignition position for a further ten seconds. This will prevent the flame-sensing device from shutting off the gas while its probe warms up as explained above.

3. If low heat is required, release the button. The button will automatically spring up to the low heat position shown in figure 2 (See note i below).

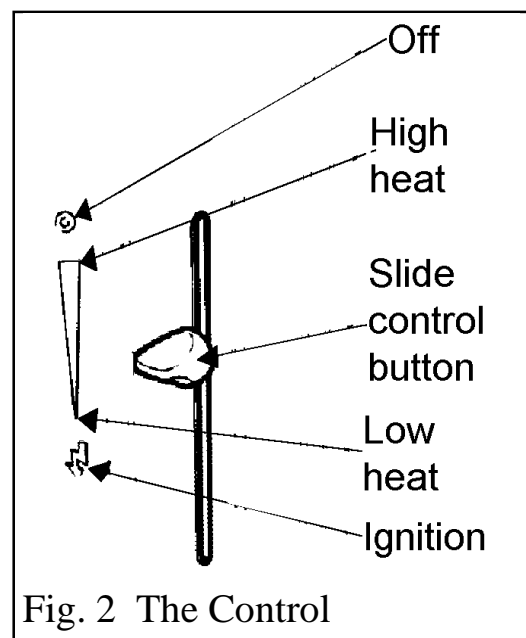

Fig. 2 The Control

# OWNER'S GUIDE

4. For a higher heat level slide the button upwards. The burner flames and heat output will gradually increase until the button reaches the high heat position shown in figure 2. When the button reaches the high heat position you will feel a check to its movement. **Do not slide the button above the high heat position unless you want to turn the fire off** (See note i below).

- Note i) If the flames go out while setting the control, repeat the full lighting procedure. If the flames repeatedly go out have the fire serviced.
- ii) Please note. When first turned on the flames will appear predominantly blue. The coals will take time to warm up. Although some glow will be seen after approximately ten minutes, the full visual effect will only be apparent after a somewhat longer time.
  - iii) The appliance will operate to its maximum potential if the flue is primed during the first 20 – 30 minutes of operation. To do this, simply slide the control button to its highest setting. This will also burn off any carbon deposits that may have formed during previous operations.
  - iv) If operating the appliance for long periods it is beneficial occasionally to change the settings. This will also help to remove any carbon deposits that may form during operation.

## To turn the fire off

Slide the button up past the high heat position to the “O” position.

Both the main burner and the pilot should go out.

While cooling, the coals may make some crackling noises. This is quite normal.

## Lighting with a taper

See figure 3.

In the unlikely event of failure of the ignition spark, the pilot can be lit by a taper or long spill. Insert the taper or spill alongside of the left side wall of the firebox and operate the slide control as described above.

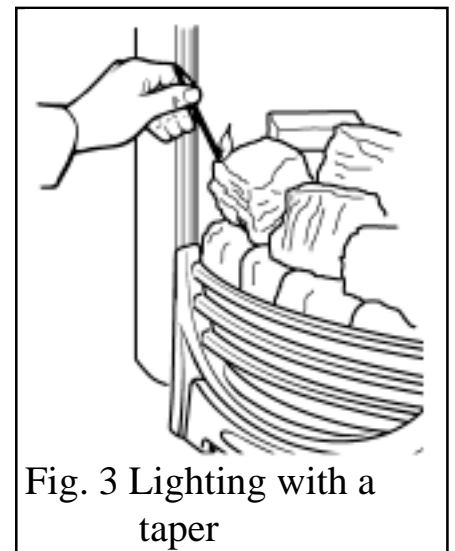

# OWNER'S GUIDE

## CLEANING

To maintain the high performance and quality finish of your fire please follow these guidelines:

- Before attempting to clean the fire, please remember to turn off the fire and wait for the appliance to cool. The fire will retain heat for some time before cleaning can begin.
- If any pieces of debris are found in the firebox, have the chimney inspected before further use.

### **Metal Parts**

- Clean the metal parts with a slightly damp cloth and then dry.
- Do not use abrasive cleaners as these will scratch the fire surface.

### **Coals and burner compartment walls**

- This product uses fuel effect pieces and burner compartment walls containing Refractory Ceramic Fibres (RCF), which are man-made vitreous silicate fibres. Excessive exposure to this material may cause temporary irritation to eyes, skin and respiratory tract. Consequently, it makes sense to take care when handling these articles to ensure that the release of dust is kept to a minimum.
- Light coatings of soot will usually be burnt off during the normal operation of the fire.
- Should any soot accumulation become excessive, the fuel effect pieces and walls should be removed from the fire for cleaning.
- Cleaning should be carried out in a well ventilated area or in the open air by gently brushing with the pieces held away from your face so that you avoid inhaling the dust.
- We do not recommend the use of a normal domestic vacuum cleaner which may blow dust back into the air.
- We suggest that you remove the coals in the reverse order to that shown in the fuel bed refitting instructions.

### **Ceramic burner**

Remove any deposits of soot or other foreign matter from the solid areas of the burner with a dry soft brush. Be careful not to brush any particles into the open slots. Remove any particles from the slots with a vacuum cleaner fitted with a soft brush attachment. **Do not poke wire, etc. into the slots in the burner.**



## FUEL BED REFITTING

If the fuel bed components are dislodged or removed, they must be refitted as follows: **Only the fuel bed parts supplied with this appliance or authorised replacements must be used. Never add extra coals above the number stated in these instructions.**

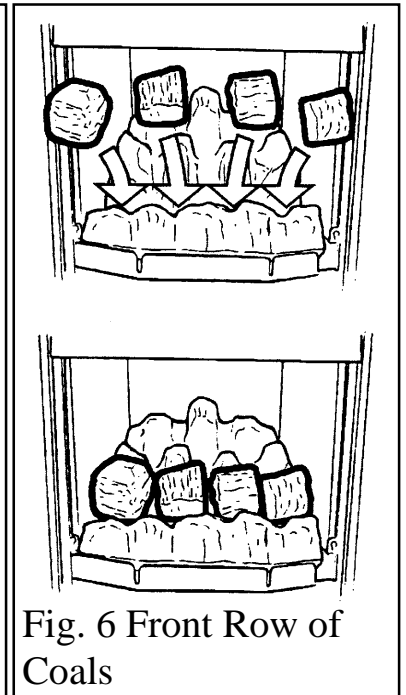
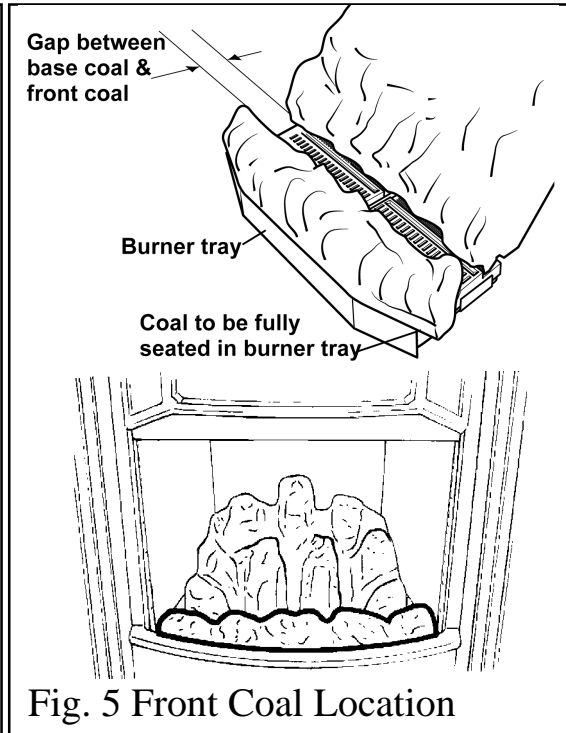
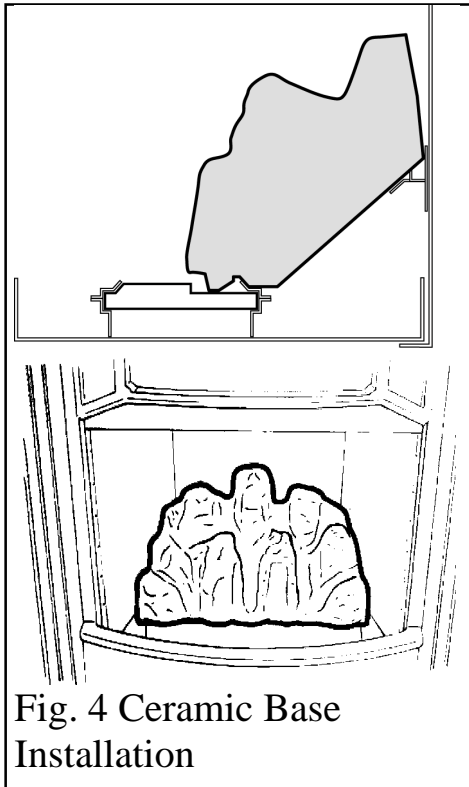

1. Place the ceramic base coal in the burner compartment. The bottom rear face of the coal should rest on the angled ledge at the back of the burner compartment. The bottom front recessed edge of the coal base should locate against the step in the burner plaques. See figure 4.

*(Installer - Note that the small round holes in the burner plaques which will be covered by the base coal are not gas burner ports. They are simply a consequence of the plaque manufacturing process).*

2. Place the ceramic front coal in position in front of the base coal. Make sure that the side legs of the front coal are fully seated into the burner tray. There will be a gap between the rear of the front coal and the front of the base coal. See figure 5.

3. Install the 13 loose coals as follows. There are 2 “finger” coals, 7 medium size coals and 4 large coals. Place all the loose coals so that they are firmly seated in the valleys in the coal base and front coal.

4. Place the 4 large coals in the valleys of the front coal. See figure 6.

# OWNER'S GUIDE

5. Place 3 of the medium size coals behind and approximately midway between the large coals as shown in figure 7. Place a “finger” coal at each end of the first two rows of coals. See figure 7.

6. Place the four remaining coals in a row at the back of the firebox compartment. See figure 8.

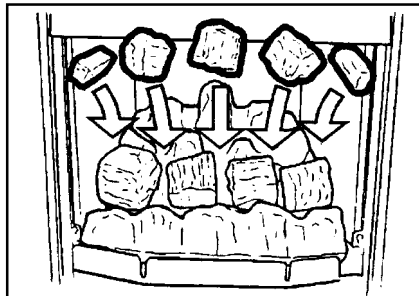

Fig. 7 Second Row of Coals

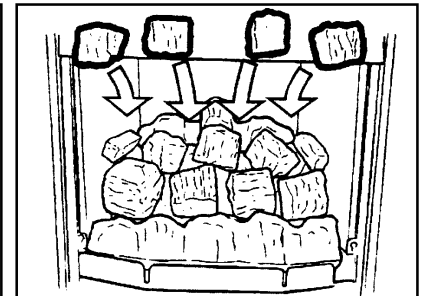

Fig. 8 Third Row of Coals

## MAINTENANCE

### Battery replacement

This appliance requires one 9V PP3 Ever Ready Silver Seal (or equivalent) battery.

To replace the battery remove the bottom front cover casting.

Fit the new battery firmly to the connections on the ignition block. See figure 9.

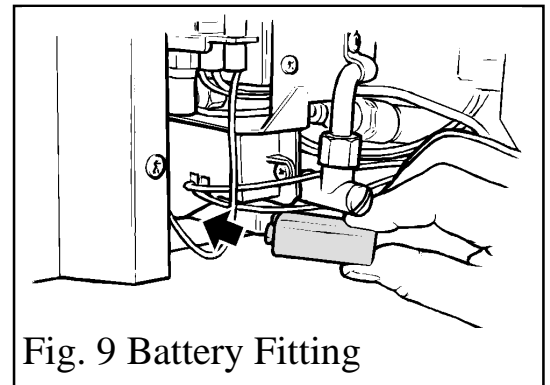

Fig. 9 Battery Fitting

### Regular maintenance

In order to achieve and maintain high levels of personal safety and performance efficiency, it is essential that the opening at the back of the fire and the flue are kept clear of any form of obstruction. It is possible that deposits of mortar or soot could fall and accumulate causing the flue to be blocked or restricted and so preventing proper clearance of dangerous exhaust fumes.

In the United Kingdom it is the law that a landlord must have any gas appliance, flue and pipework which is situated in a tenant's premises checked for safety at least every twelve months by a competent person (In the U.K, a CORGI registered installer).

We recommend that all gas appliances and their flues, wherever situated, are checked annually by British Gas or Scottish Gas.

# OWNER'S GUIDE

## Servicing

• If you require your fire to be serviced, please contact British Gas or Scottish Gas. Telephone **0845 960 5040** and please quote the following details which can be found on a label tied below the burner and behind the bottom hearth casting:

- a) - model and GC number.
- b) - appliance serial number.

The following owner replaceable parts are available.

Please quote the part number when ordering.

<b>Description</b>	<b>Part no.</b>
Base Coal	569559
Front Coal	569569
Pack of Loose Coals	9780044

- **When fitting replacement parts, follow the instructions contained in this guide. It is important that only approved parts are used for maximum safety.**