

OWNER GUIDE

Equinox

INSET LIVE FUEL EFFECT GAS FIRE

Model 754

(GC No. 32-032-59)



**THIS APPLIANCE IS FOR USE WITH NATURAL GAS (G20)
THIS APPLIANCE IS SUITABLE ONLY FOR INSTALLATION IN THE UNITED
KINGDOM (GB) AND THE REPUBLIC OF IRELAND (IE).**

This guide is intended to help you care for your gas fire. Please read thoroughly before using and keep for future reference.

Manufactured exclusively for British Gas & Scottish Gas by Valor Heating,
Wood Lane, Erdington, Birmingham B24 9QP

For Service Phone 0845 950 0400

This guide to be left with the owner

OWNER GUIDE

Safety First.

This gas fire is CE Approved and designed to meet the appropriate British Standards and Safety Marks.



Quality and Excellence.

This fire has been manufactured to the highest standards of quality and excellence and was manufactured under a BS EN ISO 9001 quality system accepted by the British Standards Institute.



The Highest Standards

The manufacturer is a member of the Society of British Gas Industries which works to ensure high standards of safety, quality and performance.



Careful Installation

The manufacturer is a CORGI registered company. This gas fire must be installed by a competent CORGI Registered Installer in accordance with our Installer Guide and should not be fitted directly on to a carpet.

Valor Heating, Erdington, Birmingham B24 9QP

www.valor.co.uk

Because our policy is one of constant development and improvement, details may vary slightly from those given in this publication

OWNER GUIDE

LIST OF CONTENTS

<u>Heading</u>	<u>Page</u>
SAFETY	4
APPLIANCE DIMENSIONS	6
GAS CONSUMPTION	6
OPERATING YOUR FIRE	7
The Oxysafe flame sensing & flue blockage safety system.	7
To light the fire	7
CLEANING	9
Metal Parts	9
Lighting with a taper	9
To turn off	9
Burner	10
Pebbles and Pebble base	10
FUEL BED REFITTING	11
MAINTENANCE	14
USEFUL TELEPHONE NUMBERS	15

This gas fire is designed to meet the most stringent quality, performance and safety requirements to provide you with many years' trouble-free service.

This guide aims to improve your understanding and appreciation of your gas fire by providing simple and informative instructions to ensure that you benefit from the excellent performance and features it has to offer.

OWNER GUIDE

SAFETY

IF YOU SMELL GAS

DON'T SMOKE

EXTINGUISH ALL NAKED FLAMES

DON'T TURN ELECTRICAL SWITCHES ON OR OFF

TURN OFF THE GAS SUPPLY AT THE METER

OPEN DOORS AND WINDOWS TO GET RID OF THE GAS

IMMEDIATELY CALL THE GAS EMERGENCY SERVICE - SEE YOUR LOCAL TELEPHONE DIRECTORY

Do have the fire installed by a competent person. In the United Kingdom, installation must be in accordance with the latest edition of the Gas Safety (installation & use) Regulations. In the Republic of Ireland, installation must be in accordance with all national and local regulations in force.

Do have the chimney swept prior to installation if it was previously used for solid fuel.

Do have the fire installed in accordance with the installation instructions.

Do provide a minimum clearance as shown in graph 1 above the hearth to any shelf made of wood or other combustible material. Please bear this in mind if you are making any alterations to the room.

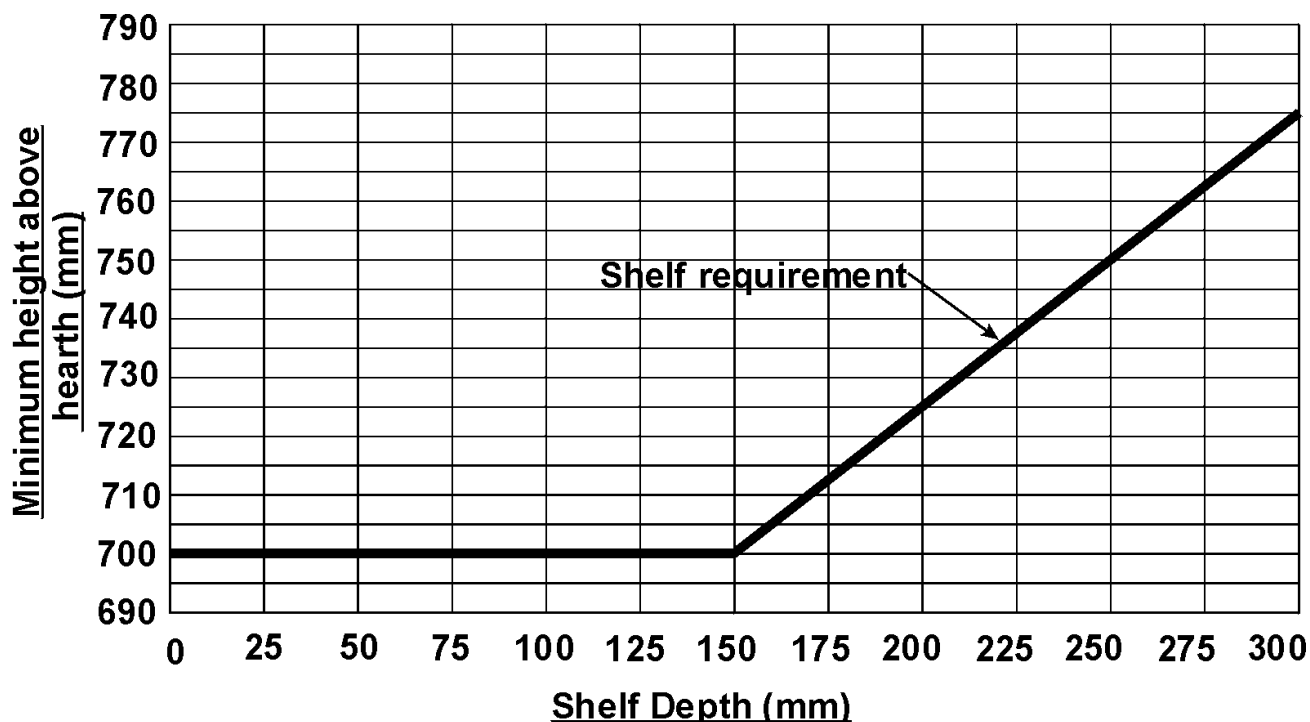

Graph 1. Combustible shelf clearances

OWNER GUIDE

Do provide a suitable guard that complies with BS 8423 for the protection of young children, the elderly and the infirm. Such a guard is also recommended for the protection of pet animals. (Although this fire conforms to all the applicable standards, it is a heating appliance and certain parts of its surface will become hot).

Do wait three minutes before attempting to relight if the fire is switched off or the flames are extinguished for any reason. (Your fire is fitted with a safety device that will automatically shut off the gas supply to the fire if, for any reason, the flames go out).

Do get advice about the suitability of any wall covering near your fire. Soft wall coverings (e.g. embossed vinyl, etc.) which have a raised pattern are easily affected by heat. They may, therefore, scorch or become discoloured when close to a heating appliance. Please bear this in mind whenever you are considering redecorating.

Do provide a minimum side clearance as detailed in figure 1. Please bear this in mind if ever you are considering altering the room.

Don't hang clothing, towels or any other fabrics over the fire.

Don't add any extra pebbles above the number stated in this guide. This could cause a safety hazard.

Don't put paper or any other material on the fire.

Don't place any combustible material (rugs, carpet, plastic tiles, etc.) on the hearth.

Don't attempt to clean or service the fire until it has been switched off and allowed to cool completely.

OWNER GUIDE

APPLIANCE DIMENSIONS

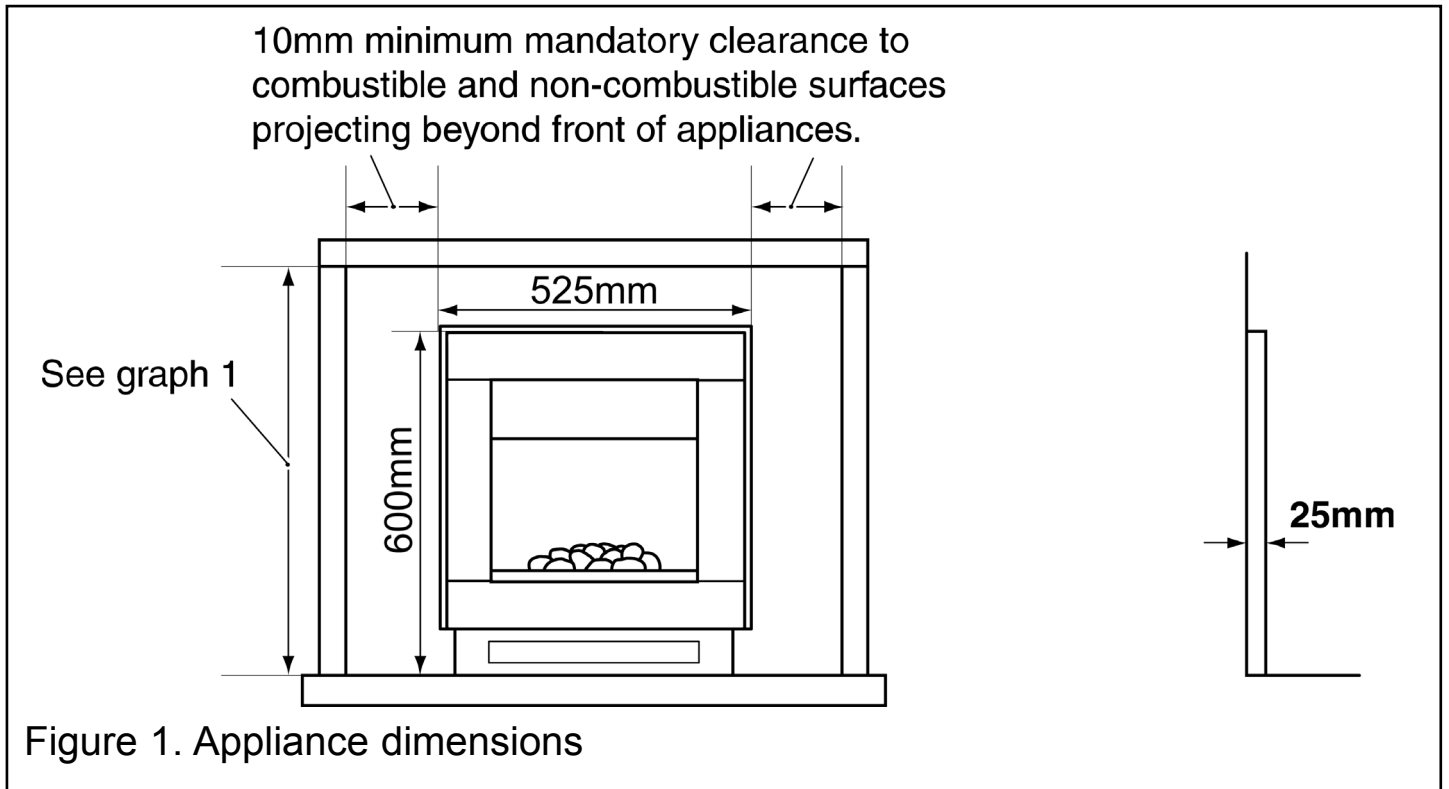

GAS CONSUMPTION

Model 754

- Has a maximum natural gas input of 5.1kW (Gross)
- Has a maximum natural gas output of 2.6kW (Gross)
- Has a minimum natural gas input of 3.0kW (Gross)
- Has a minimum natural gas output of 1.5kW (Gross)

OWNER GUIDE

OPERATING YOUR FIRE

PLEASE NOTE

When operating your fire for the first time, some vapours may be given off which may cause a slight odour and could possibly set off any smoke alarms in the immediate vicinity. These vapours are quite normal with new appliances. They are totally harmless and will disappear after a few hours use.

The Oxysafe flame sensing & flue blockage safety system.

For your safety, this appliance is fitted with a flue blockage safety device which will shut down the appliance in the event of abnormal flue conditions. ***This device is NOT a substitute for an independently mounted Carbon Monoxide detector.***

The device will also automatically shut off the gas supply to the fire if the pilot flame goes out due to lack of oxygen or for any other reason.

If this device starts to repeatedly shut off the gas, get expert advice.

This device incorporates a probe which senses that the heat from the pilot flame is correct. If this probe is cool, the device will prevent any gas flow unless the control knob is held in at the ignition position.

If, for any reason, the flames go out when the fire is hot or if the fire is turned off when hot, always ***wait at least three minutes before attempting to relight.***

To light the fire

- To get access to the control knob lower the bottom front cover. To do this, support the top and bottom of the lower front cover (See figure 2).
- Depress the control knob and turn anticlockwise towards the PILOT/IGN position (See figure 3). A spark should be generated at the pilot while turning. The spark should ignite the pilot. The pilot flame can be seen at the left side of the pebbles.

Keep the button at the PILOT/IGN position for a further ten seconds. This will prevent

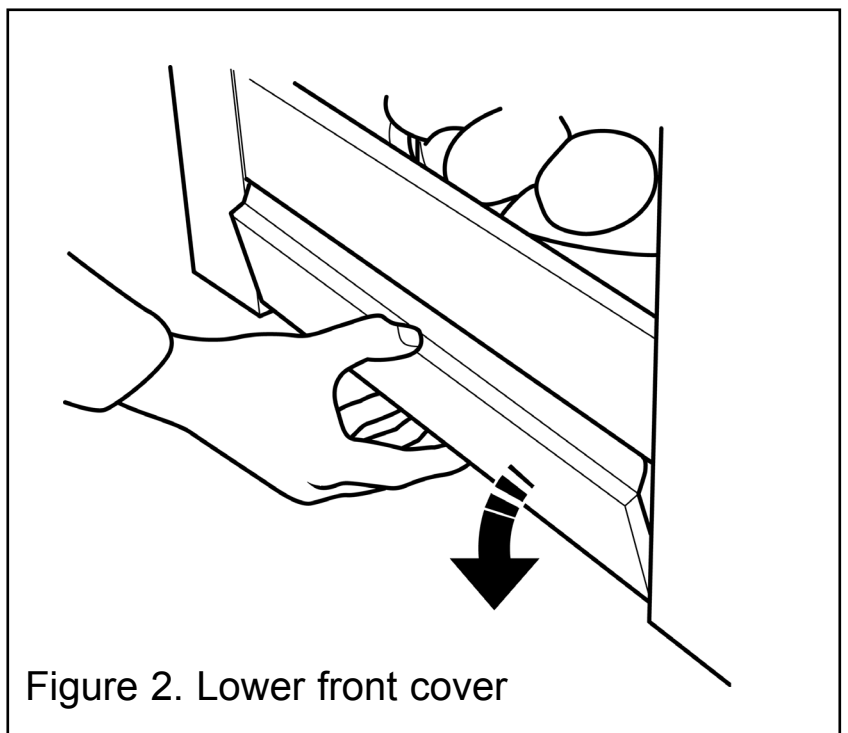

Figure 2. Lower front cover

OWNER GUIDE

the flame sensing device from shutting off the gas while its probe warms up as explained previously.

- If the pilot does not ignite quickly repeat the procedure.

If after 10 seconds pilot ignition has not occurred, turn the control knob back to the “Off” position, wait for 3 minutes and then repeat the ignition procedure.

- When the pilot is alight and stable, partially depress the knob and turn to “LOW”. The pilot should then light the main burner at its low setting. There may be a delay of up to

four seconds between the pilot lighting and ignition of the gas at the main burner. This is normal and is due to the time required to fill the main burner compartment with sufficient gas for ignition.

- When the main burner is alight at its low setting, partially depress the knob and gradually turn it anti-clockwise until the burner is at your desired level. The burner flames will gradually increase until the knob reaches the “HIGH” position.

- Note:**
- i) If the flames go out while setting the control, repeat the full lighting procedure. If the flames repeatedly go out have the fire serviced.
 - ii) Please note. When first turned on the flames will appear predominantly blue. The pebbles will take time to warm up. Although some glow will be seen after approximately ten minutes, the full visual effect will only be apparent after a somewhat longer time.
 - iii) The appliance will operate to its maximum potential if the flue is primed during the first 20 – 30 minutes of operation. To do this, simply set the control knob to its ‘HIGH’ setting. This will also burn off any carbon deposits that may have formed during previous operations.
 - iv) If operating the appliance for long periods it is beneficial occasionally to change the settings. This will also help to remove any carbon deposits that may form during operation

Lighting with a taper

See figure 4.

In the unlikely event of failure of the ignition spark, the pilot can be lit by a taper or

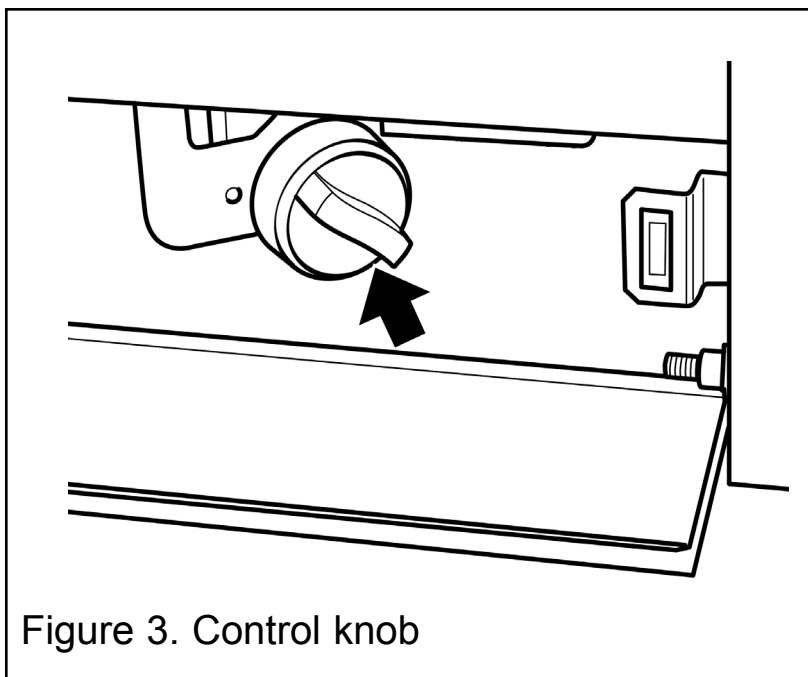

Figure 3. Control knob

OWNER GUIDE

long spill. Insert the taper or spill into the gap underneath the pebble at the extreme left hand side of the fuel bed. Depress the control knob, turn it to PILOT/IGN

To turn off

- To turn the main burner off but leave the pilot alight, partially depress the knob and turn to PILOT/IGN.
- To turn the fire fully off, partially depress the knob and turn to OFF.
- **Wait at least three minutes before relighting.**
- **While cooling, the pebbles may make some crackling noises. This is quite normal.**

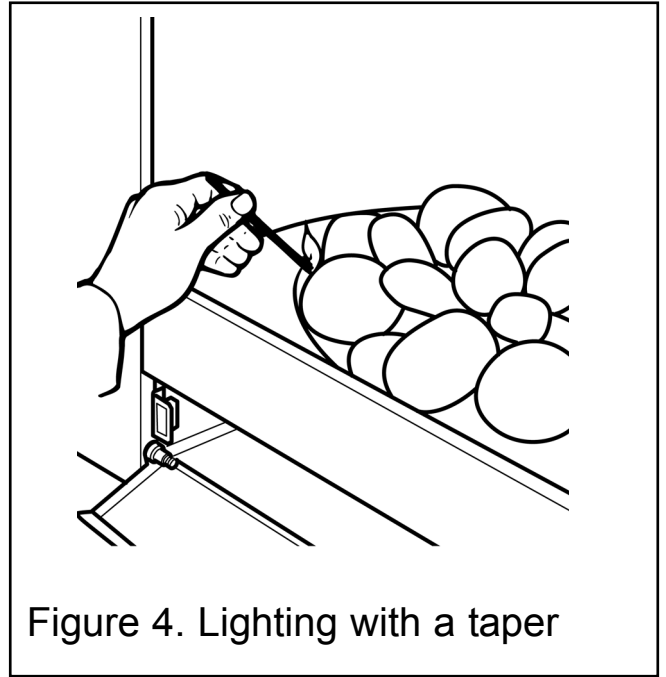

Figure 4. Lighting with a taper

CLEANING

To maintain the high performance and quality finish of your fire please follow these guidelines:

- Before attempting to clean the fire, please remember to turn off the fire and wait for the appliance to cool completely. The fire will retain heat for some time before cleaning can begin.
- If any pieces of debris are found in the hotbox, have the chimney inspected before further use.

Metal Parts

- Clean the metal parts with a slightly damp, lint free non-abrasive cloth and then dry.
- Do **not** use abrasive cleaners, as these will scratch the fire surface.
- **Front surround** -Clean the metal parts with a slightly damp cloth and then dry. If this does not work apply a very small amount of 'baby oil' to a lint free, non-abrasive cloth and wipe over the surface. Use a clean cloth to wipe off the oil.
- Note: The decorative metal surfaces within the firebox are exposed to high temperatures. Great care has been taken to ensure that discolouration is kept to a minimum. However, the combination of heat and variable flue conditions may result in small amounts of discolouration or staining.

OWNER GUIDE

Pebbles and Pebble base

- **This product uses fuel effect pieces containing Refractory Ceramic Fibres (RCF), which are man-made vitreous silicate fibres. Excessive exposure to this material may cause irritation to eyes, skin and respiratory tract. Consequently, it is important to take care when handling these articles to ensure that the release of dust is kept to a minimum.**
- In the unlikely event of soot forming, light coatings will usually be burnt off during the normal operation of the fire.
- Should any soot accumulation become excessive, the fuel effect pieces should be removed from the fire for cleaning.
- Cleaning should be carried out in a well ventilated area or in the open air by gently brushing with the pieces held away from your face so that you avoid inhaling the dust.
- We do not recommend the use of a normal domestic vacuum cleaner which may blow dust back into the air.
- We suggest that you remove the pebbles in the reverse order to that shown in the fuel bed refitting instructions.

Burner

Remove any deposits of soot or other foreign matter from the solid areas of the burner with a dry soft brush. Be careful not to brush any particles into the open holes. Remove any particles from the holes with a vacuum cleaner fitted with a soft brush attachment.

Do not poke wire, etc. into the holes in the burner.

OWNER GUIDE

FUEL BED REFITTING

1. The front base pebble has the letters 'MF' on the underside. Locate the front base pebble in front of the burner (See figure 5)

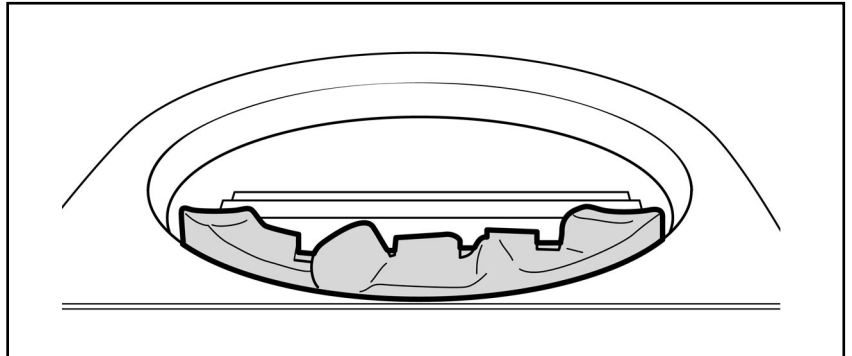

Figure 5. Front base pebble location

2. The rear base pebble has the letters 'MB' on the underside. Locate the rear base pebble behind the burner (See figure 6)

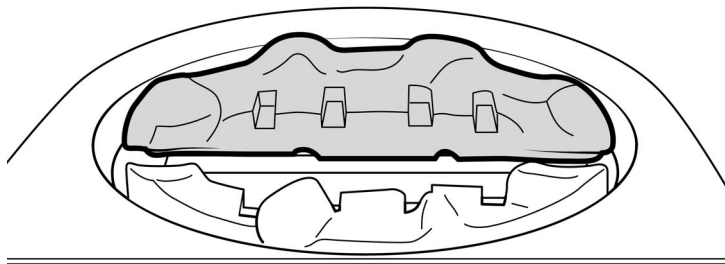

Figure 6. Rear base pebble location

3. There are four ceramic support rods. Locate the ceramic support rods into the slots of the ceramic base (See figure 7)

The position of the pebbles is important. Do not alter the position of the pebbles from that shown in this section of the owner's guide.

4. The loose pebbles are numbered and lettered on the underside. They are numbered '1' to '5' and 'A' to 'D'. There should be four number '1' pebbles, two number '2' pebbles, one number '3' pebble, one number '4' pebble, two number '5' pebbles, two pebbles lettered 'A', two pebbles lettered 'B', two pebbles lettered 'D' and one pebble lettered 'C'.

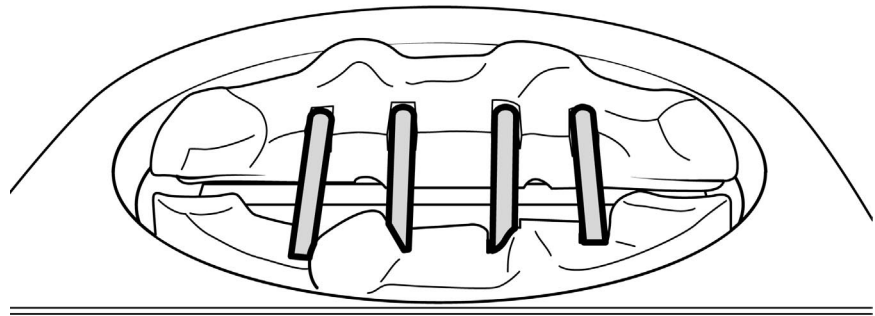

Figure 7. Ceramic support rod location

OWNER GUIDE

4. There are two pebbles numbered '5'. They have a central location peg on the underside. Locate the first pebble '5' centrally between the left hand ceramic support rods (See figure 8). Locate the second pebble '5' centrally between the right hand ceramic support rods (See figure 8). They will now be positioned directly above the burner ports

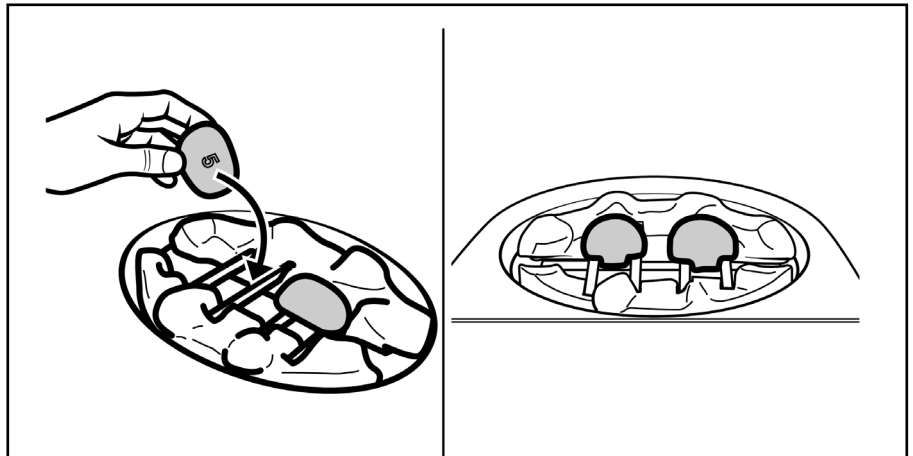

Figure 8. Pebble number '5' location

5. Pebble '3' has a location peg on the underside. The peg has a chamfer on one side. The chamfer must face the burner. Locate pebble '3' onto the left hand side of the pebble base. It should bridge the gap between the front and rear halves of the pebble base. **The location peg on pebble '3' should not cover the burner ports.**

Pebble '3' should be as far to the left hand side as possible. (Figure 9).

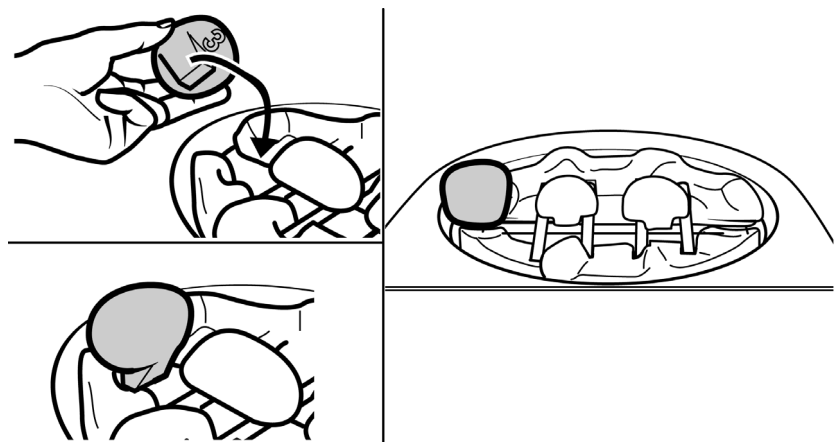

Figure 9. Pebble number '3' location

6. Pebble '4' has a location peg on the underside. The peg has a chamfer on one side. The chamfer must face the burner. Locate pebble '4' onto the right hand side of the pebble base. It should bridge the gap between the front and rear halves of the pebble base. **The location peg on pebble '4' should not cover the burner ports.**

Pebble '4' should be as far to the Right hand side as possible. (See figure 10).

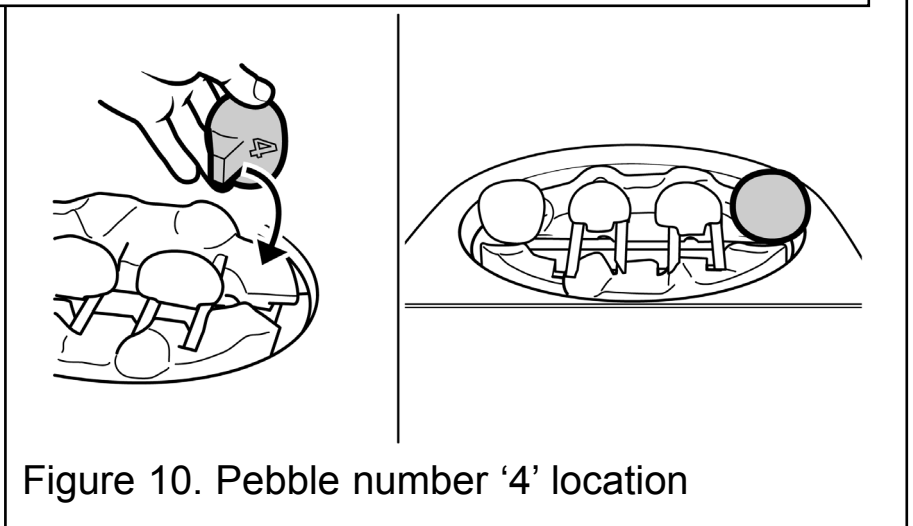

Figure 10. Pebble number '4' location

OWNER GUIDE

7. There are four pebbles numbered '1' on the underside. Locate these onto the pebble base at the ends of the outer left and right hand ceramic support rods (See figure 11). Leave a gap between pebble '3' and the pebble '1' as shown in figure 11. This will allow the pilot flame to be viewed.

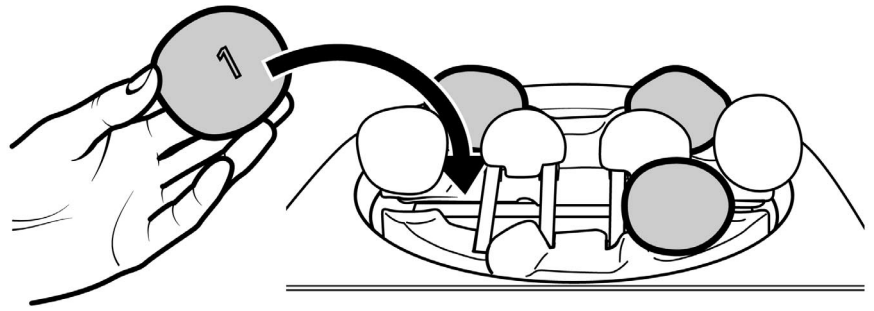

Figure 11 Pebble number '1' location

8. There are two pebbles numbered '2' on the underside. Locate these on the pebble base between the ends of the inner left and right ceramic support rods (See figure 12).

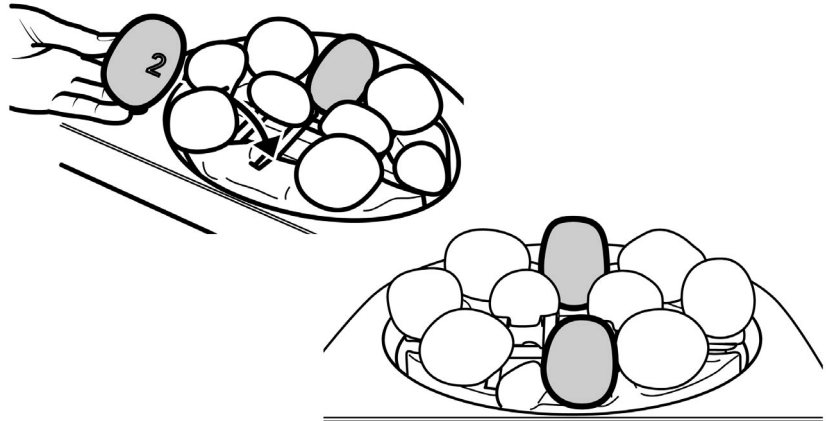

Figure 12. Pebble number '2' location

Important note: The gap between the number '2' pebbles affects the final flame picture. If the flames tend to the sides of the fuel bed then increase the gap between the number '2' pebbles. If the flames tend to the centre of the fuel bed then decrease the gap between the number '2' pebbles. The amount of movement may be as little as 3 – 5mm.

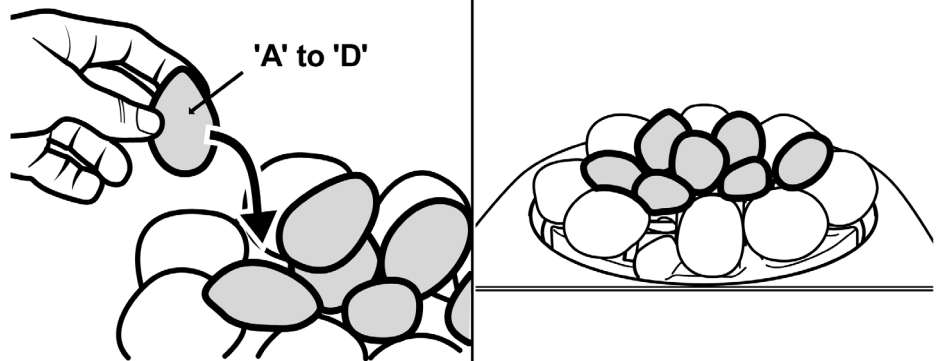

Figure 13. Pebbles lettered 'A' to 'D' location

9. There are seven pebbles lettered 'A' to 'D' on the underside. Locate these evenly over the top of the first layer of pebbles (See figure 13). To optimise the flame picture it may be necessary to position these pebbles away from the centre of the fuel bed allowing more central flames.

OWNER GUIDE

MAINTENANCE

Regular maintenance

In order to achieve and maintain high levels of personal safety and performance efficiency, it is essential that the opening at the back of the fire and the flue are kept clear of any form of obstruction. It is possible that deposits of mortar or soot could fall and accumulate causing the flue to be blocked or restricted and so preventing proper clearance of dangerous exhaust fumes.

In the United Kingdom it is the law that a landlord must have any gas appliance, flue and pipework which is situated in a tenant's premises checked for safety at least every twelve months by a competent person (In the U.K, a CORGI registered installer).

We recommend that all gas appliances and their flues, wherever situated, are checked annually.

Servicing

- If you require your fire to be serviced, please contact British Gas or Scottish Gas **TELEPHONE 0845 950 0400** and please quote the following details which can be found on a 'swing' plate located below the burner behind the bottom hearth casting

To help us quickly help you, please try to have the following information available before you contact us:

- a) Your Post Code.**
 - b) Type of fire and front and colour**
 - c) Model/Name.**
 - d) Serial Number (To be found on a 'swing' plate located below the burner and behind the lower front cover).**
 - e) The fault, problem or request.**
- If you wish to replace any of the owner replaceable parts listed below, please quote the following part numbers.

Description	Part No.
Front Base pebble	5108545
Rear Base pebble	5108546
Pack of 17 Loose Pebbles	3002802
Set of 4 ceramic support rods	3002478

- When fitting replacement parts, follow the instructions contained in this guide. It is important that only approved parts are used for maximum safety.