



## Logamax plus GB162-65/80/100

For the end user

Please read thoroughly  
before operating the boiler.

# Table of contents

<b>1</b>	<b>Overview of Logamatic BC10 basic controller</b>	<b>5</b>
<b>2</b>	<b>Permanent clearances</b>	<b>6</b>
<b>3</b>	<b>For your safety</b>	<b>7</b>
3.1	Intended use	7
3.2	Please observe these instructions	7
3.3	Heating room	7
3.4	Combustion air flue gas connection	7
3.5	Quality of the heating system water	7
3.6	Working on the boiler	7
3.7	Maintenance schedule	8
3.8	CE label	8
3.9	Abbreviations	8
<b>4</b>	<b>Explanation of the control unit</b>	<b>9</b>
4.1	General	9
<b>5</b>	<b>Commissioning the heating system</b>	<b>12</b>
5.1	Checking and correcting the system pressure	12
5.1.1	Filling the heating system	13
5.2.1	Setting the CH (boiler) flow temperature	15
5.2.2	Setting the DHW temperature	16
5.2.4	Setting the room controller	17
<b>6</b>	<b>Operating the heating system</b>	<b>18</b>
6.1	Menu structure	18
6.1.1	Normal Operation menu	18
6.1.3	Settings menu	20
<b>7</b>	<b>Shutting down the heating system</b>	<b>22</b>
7.1	Shutting down the heating system using the control unit	22
7.2	Shutting down the heating system in case of an emergency	22
7.3	Shutting down the heating system in case of the risk of freezing (interruption of use)	23
7.4	Long-term absence while there is a risk of freezing	23
<b>8</b>	<b>Display information</b>	<b>24</b>
8.1	Display readings	24
8.2	Display settings	24
8.3	Display codes	24
8.4	Identifying and resetting faults	26

# Preface

Dear customer,

This User Manual has been produced for use with the following wall-mounted condensing gas boilers:

- Logamax plus GB162-65
- Logamax plus GB162-80
- Logamax plus GB162-100.

This User Manual offers the user of the heating system an overview of the use and operation of the boiler. The Quick Reference Manual is located in the boiler, inside the control panel door (→ fig. 3 on page 9).

To ensure the safe, economic and environmentally-friendly use of the heating system we advise you to read and observe the safety instructions and the User Manual.

## Important general instructions for use

This device should only be used for its intended purpose and in accordance with the regulations. It is a requirement and in your own interest, and that of safety that this boiler must be installed by a Gas Safe registered installer, in accordance with the relevant requirements of the current Gas Safety (Installation and Use) Regulations, The Building Regulations, current I.E.E. Wiring Regulations and the relevant British Standard Codes of Practice.

The device may only be used in combination with the units, accessories and spare parts listed in the installation and maintenance instructions. Other combinations of units, accessories and consumables are only to be used if they completely fulfil the specifications involved, and if system performance and safety are not affected in any way.

Detailed recommendations are contained in the following British Standard Codes of Practice.

## Regulations and directives for all rated input installation

### BS 1212

### BS 4814:1990

Specification for expansion vessels using an internal diaphragm, for sealed hot water heating systems.

### BS 5482

Code of practice for domestic butane- and propane-gas-burning installations. Installations at permanent dwellings, residential park homes and commercial premises, with installation pipework sizes not exceeding DN 25 for steel and DN 28 for corrugated stainless steel or copper.

### BS 6281-1:1992

Devices without moving parts for the prevention of contamination of water by backflow. Specification for type A air gaps.

### BS 6282-1:1992

Devices with moving parts for the prevention of contamination of water by backflow. Specification for check valves of nominal size up to and including DN 54.

### BS 6283-4:1991

Safety and control devices for use in hot water systems. Specification for drop-tight pressure reducing valves of nominal size up to and including DN 50 for supply pressures up to and including 12 bar.

### BS 6880

Code of practice for low temperature hot water heating systems for output greater than 45 kW.

### BS 6891:2005

Installation of low pressure gas pipework of up to 35 mm (R1¼) in domestic premises (2nd family gas).

### BS 7671:2008

Requirements for Electrical Installations IEE Wiring Regulations seventeenth edition.

### BS EN 303-7

Heating boilers. Gas-fired central heating boilers equipped with a forced draught burner of nominal heat output not exceeding 1000 kW.

### CISBE

Guide Reference sections B7, B11 and B13.

### CP 342-2:1974

Code of practice for centralized hot water supply. Buildings other than individual dwellings.

### IGE/UP/2

Gas installation pipework and compressors on industrial and commercial premises

### IGE/UP/10

Installation of gas appliances in industrial and commercial premises, part 1: flued appliances

## Installation not exceeding 70 kW rated input

### BS 5440

Installation and maintenance of flues and ventilation for gas appliances of rated heat input not exceeding 70 kW net (1st, 2nd and 3rd family gases). Specification for installation and maintenance of flues.

### BS 5449

Specification for forced circulation hot water central heating systems for domestic premises.

### BS 5546

Specification for installation of hot water supplies for domestic purposes, using gas-fired appliances of rated input not exceeding 70 kW (2nd. family gases).

### BS 6798

Specification for installation of gas-fired boilers of rated input not exceeding 70 kW net.

### BS 7593

Code of practice for treatment of water in domestic hot water central heating systems.

### BS EN 483

Gas-fired central heating boilers. Type C boilers of nominal heat input not exceeding 70 kW.

### BS EN 677

Gas-fired central heating boilers. Specific requirements for condensing boilers with a nominal heat input not exceeding 70 kW.

## Installation of rated input greater than 70kW

### BS 6644

Specification for Installation of gas-fired hot water boilers of rated inputs between 70 kW (net) and 1.8 MW (net) (2nd and 3rd family gases).

### BS EN 15417:2006

Gas-fired central heating boilers. Specific requirements for condensing boilers with a nominal heat input greater than 70 kW but not exceeding 1000 kW.

### BS EN 15420

Gas-fired central heating boilers. Type C boilers of nominal heat input exceeding 70 kW, but not exceeding 1000 kW.

The boiler name is made up of the following elements:

GB: Condensing gas boiler  
162: Type  
65, 80 or 100: Heating range in kW

Buderus has a policy of constant product improvement, which may result in deviations in technical data. If you have any suggestions for improvements or have found any discrepancies, please do not hesitate to contact us.

Buderus,  
Cotswold Way, Warndon, Worcester  
WR4 9SW,  
United Kingdom  
E-Mail: [info@buderus-commercial.co.uk](mailto:info@buderus-commercial.co.uk)

Document no.: 7217 5100 (03/2010) GB

The manufacturer of the boiler is not responsible for any damage due to failures to observe the instructions in this User Manual.

If you have any doubts or questions, please contact the installer or the service company.

Due to the high efficiency of the boiler a plume of water vapour may form at the terminal during operation. This is normal.



Manufacturer's notes must not be taken in any way as overriding statutory obligations.

---

# 1 Overview of Logamatic BC10 basic controller

Item	Description
1	Mains switch (Heating On/Off)
2	"Reset" button (fault reset button)
3	"Chimney sweep" button (for manual operation)
4	"Service" button
5	Service Connector (for the registered installer)
6	"Burner" LED (On/Off)
7	"Heat demand" LED
8	Maximum CH (boiler) flow temperature dial
9	Display (for status indication)
10	"DHW mode" LED
11	DHW temperature dial

table 1 Key to fig. 1

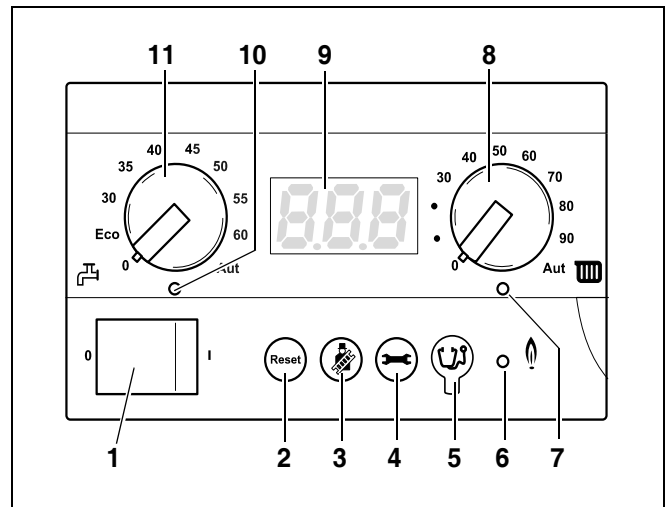
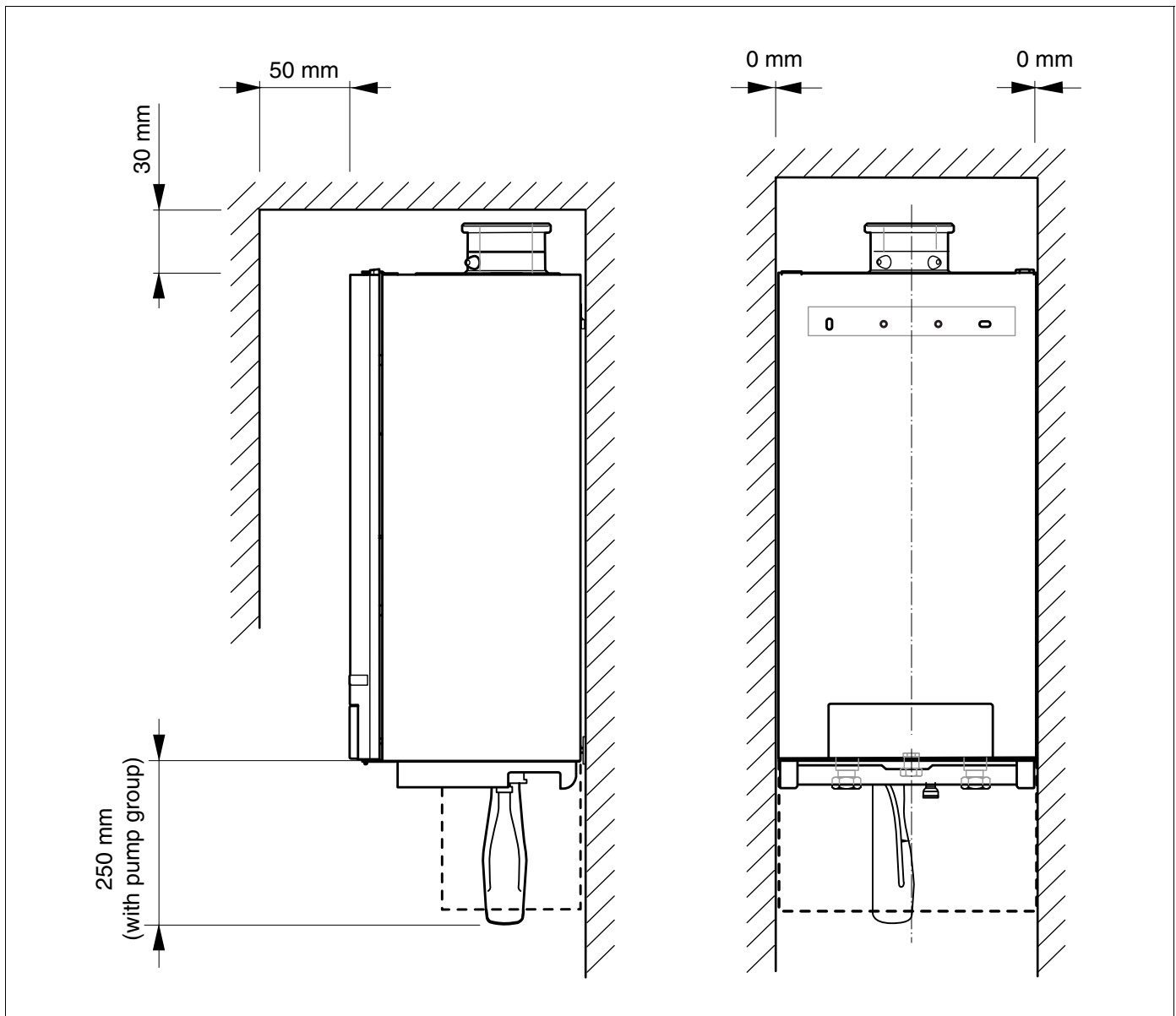

fig. 1 BC10 basic controller

## 2 Permanent clearances

The boiler must be located in an area with the following permanent clearances.



The installer or service engineer must be able to create sufficient service clearances.

These clearances should have been considered at time of installation.

## 3 For your safety

### 3.1 Intended use

This boiler is only to be used to heat heating system water and for the domestic hot water (DHW) supply e. g. in residential and light commercial properties. It can also be integrated into a cascade system (where several boilers are interconnected).

The boiler has been factory-fitted with the Logamatic BC10 basic controller and the "Universal Burner Automat 3" (UBA 3).

### 3.2 Please observe these instructions



#### **DANGER OF FATAL ACCIDENT**

from explosive fumes.

If you smell gas, there is a danger of explosion.

- No naked lights. No smoking. Do not use lighters!
  - DO NOT operate any device that is likely to produce sparks. Do not operate any electrical switches, including telephones, plugs or doorbells.
  - Shut off the main gas supply!
  - Open doors and windows.
  - Warn the residents but do not ring the doorbells!
  - Contact the gas utility company from a telephone located outside the building!
  - If you can hear gas leaking out, evacuate the building immediately, prevent other people from entering, and notify the police and fire service immediately (from a telephone OUTSIDE the building).
- In other hazardous situations, immediately shut off the main gas supply and interrupt the power supply to the heating system by pulling the mains plug from the socket.

### 3.3 Heating room



#### **FIRE HAZARD**

due to flammable materials or liquids.

- Ensure that there are no flammable materials or liquids in the direct vicinity of the boiler.



#### **DAMAGE TO THE INSTALLATION**

due to freezing.

- Make sure that the room where the boiler is installed is free from frost.

### 3.4 Combustion air flue gas connection

For room air-dependent operation of the boiler, the installation room must have the required air vents. Do not obstruct these vents. The air vents must always be free.

### 3.5 Quality of the heating system water

Use only untreated tap water when filling or topping up the heating system. The use of unsuitable heating system water will lead to build-ups of sludge and corrosion, which can in turn result in the malfunctioning of the boiler and damage to the heat exchanger.

DO NOT treat the water with products such as pH-adjusting substances (chemical additives) and anti-freeze or water softeners.

### 3.6 Working on the boiler

All installation, commissioning, inspection and maintenance activities and any repairs may only be carried out by a registered Gas Safe installer in accordance with the instructions in the Inspection and Service Record Log Book.

### 3.7 Maintenance schedule



#### **DAMAGE TO THE INSTALLATION**

due to insufficient or improper cleaning and maintenance.

- Have the heating system inspected, cleaned and serviced by a registered Gas Safe installer once a year.
- We advise you to enter into a contract for annual inspection and maintenance.

### 3.8 CE label



The appliance complies with the basic requirements of the relevant European directives.

Conformity has been substantiated by the proper documents which - together with the declaration of conformity - are filed with the manufacturer.

### 3.9 Abbreviations

CH (boiler) flow =	Central Heating flow
CH return =	Central Heating return
DHW outlet=	Domestic Hot Water warm outlet
MCW inlet =	Mains Cold Water inlet
UBA 3 =	Universal Burner Automat 3



## 4 Explanation of the control unit

### 4.1 General

The boiler is fitted with a control unit, the BC10 basic controller (→ fig. 2). This controller can be used to control the heating system.



If your heating system consists of several boilers (cascade system), you have to carry out the settings on the control units of all individual boilers.

- Push on the control panel to open it (→ fig. 2).

The BC10 basic controller is located on the left, behind the door (fig. 3, **item. 2**).

The User Manual for the boiler is located in a compartment on the rear side of the door (fig. 3, **item. 1**).

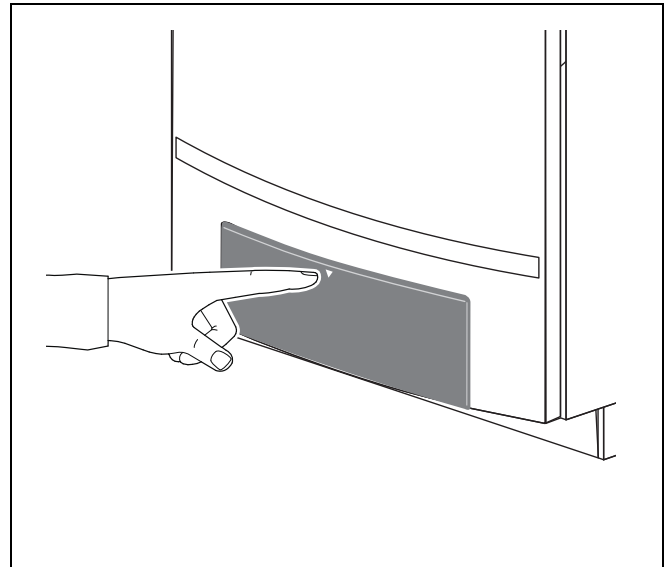

fig. 2 Opening the control panel

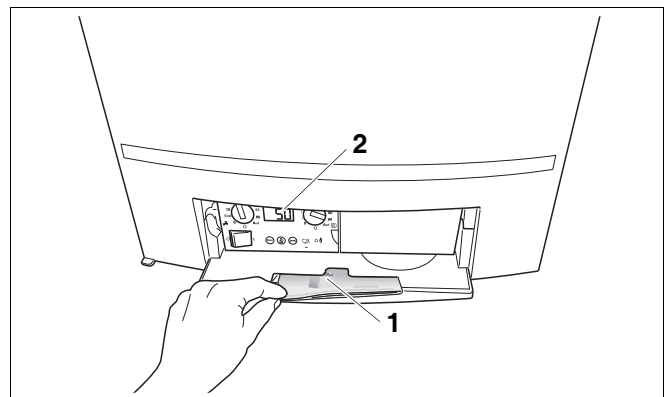

fig. 3 BC10 and User Manual

**The BC10 basic controller consists of the following components:**

#### Mains switch

The mains switch (fig. 4, **item 1**) is used to switch the boiler on and off.

#### "Reset" button

If a fault has occurred you may have to restart the boiler by pressing the "Reset" button (fig. 4, **item 2**).

This is only required in the event of a "locking" fault. "Blocking" faults are reset automatically as soon as their cause has been removed. The display shows **rE** during the reset operation.

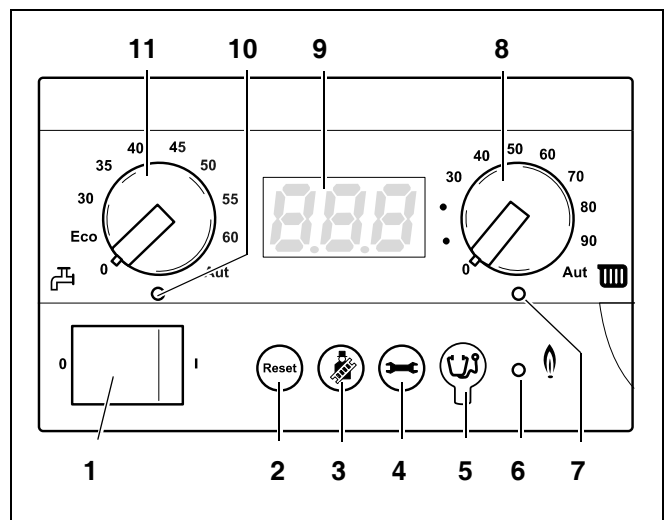

fig. 4 BC10 basic controller

**"Chimney sweep" button**

The "Chimney sweep" button (fig. 5, **item 3**) is used to put the boiler into manual operation mode, e.g. if the heating system control (e.g. room controller) is defective.

The heating system can be operated in manual mode, independent of a room controller on a temporary basis. The control system must comply with Part L1 + L2. In this case, the CH (boiler) flow temperature setting of the right-hand dial is used as the temperature for boiler operation. See table 6 "Manual Operation menu".



**DAMAGE TO THE INSTALLATION**

due to freezing while manual operation is switched on.

After a power failure or after switching off the supply voltage, the heating system may freeze since manual operation is no longer active.

- Re-activate manual operation after switching on the heating system, so that the system is permanently in operation (especially if there is a risk of freezing).

**"Service" button**

The "Service" button (fig. 5, **item 4**) is used to display the current CH (boiler) flow temperature, the current working pressure etc. Also see section 6.1.1, page 18.

**Service Connector**

The heating engineer can connect a Service Tool here (fig. 5, **item 5**) for diagnostic purposes when servicing.

**"Burner" (On/Off) LED**

The "Burner" (On/Off) LED (fig. 5, **item 6**) lights up when the burner of the boiler is switched on and it is extinguished when the burner is switched off.

The "Burner" (On/Off) LED indicates the burner status.

LED	Status	Explanation
On	Burner operational	Boiler water is being heated.
Off	Burner off	The CH (boiler) flow temperature has reached the set temperature or there is no heat demanded.

table 2 Meanings of "Burner" (On/Off) LED indications

**"Heat demand" LED**

The "Heat demand" LED (fig. 5, **item 7**) lights up when the control system has made a heat demand and it is extinguished when this heat demand is no longer required.

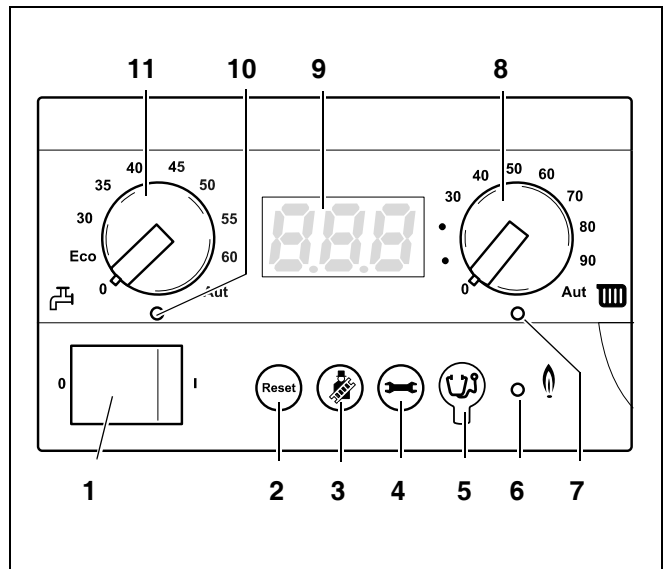

fig. 5 BC10 basic controller

### Maximum CH (boiler) flow temperature dial

The maximum CH (boiler) flow temperature (fig. 6, **item 8**) is used to set the upper CH (boiler) flow temperature limit. The unit is °C.



#### DAMAGE TO THE INSTALLATION

with underfloor heating: by the floor being overheated.

- Limit the maximum CH (boiler) flow temperature using the "CH (boiler) flow temperature" dial (fig. 6, **item 8**) to the permissible flow temperature of the floor heating circuit (usually maximum 40 °C).

### Display

The heating system status and values can be read out from the display (fig. 6, **item 9**). If a fault occurs the display will immediately show the accompanying fault code. The fault code display will flash if a locking fault is detected.

### DHW temperature dial

The DHW temperature dial (fig. 6, **item 11**) is used to select the required temperature of the hot water in the hot water cylinder. The unit is °C.

### "DHW mode" LED

The "DHW mode" LED (fig. 6, **item 10**) lights up when a DHW request has occurred and it is extinguished when this DHW request is no longer required.

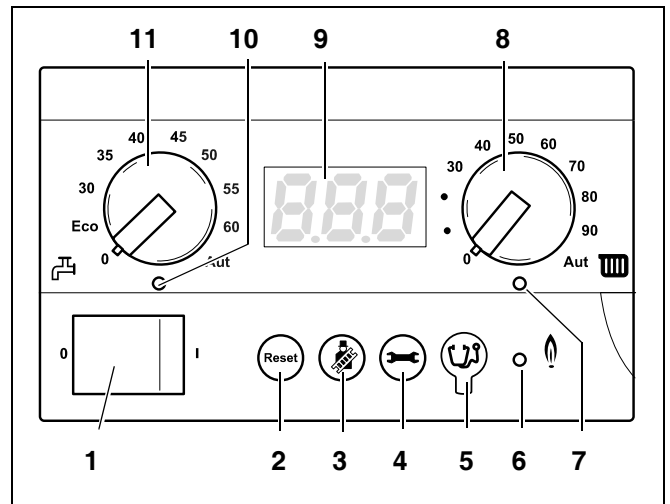

fig. 6 BC10 basic controller

## 5 Commissioning the heating system

This chapter explains how you can start up your heating system, e.g. after a holiday.

### 5.1 Checking and correcting the system pressure

If the heating system has been newly filled, the system pressure must initially be checked every day, for 1 week. The maximum pressure in the heating system, measured directly at the boiler, must not exceed 2.5 bar.

- Switch on the mains switch (fig. 7, **item 1**) on the BC10 (position "1").
- Press the "Service" button (fig. 7, **item 4**) until the system pressure ("P1.5") is shown in the display (fig. 7, **item 9**). Also see section 6.1.1, "Normal Operation menu", page 18.

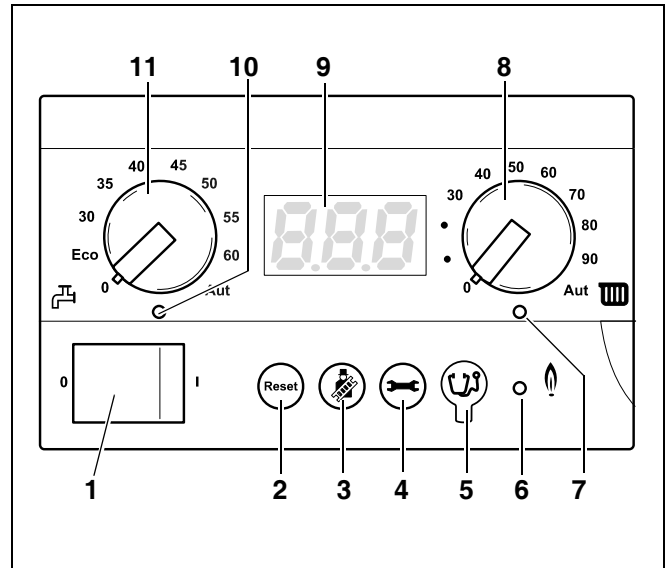

fig. 7 BC10 basic controller

Fill the heating system as follows if the system pressure has dropped to below 1.0 bar:

- Remove the lower casing from the connection group (fig. 8).

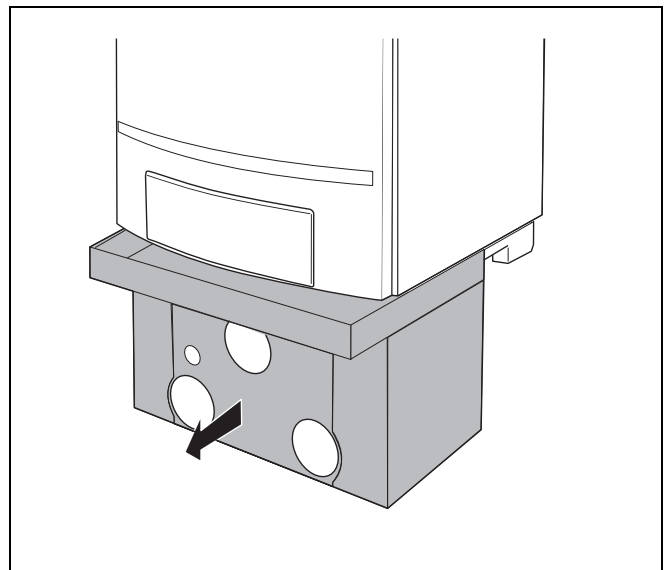

fig. 8 Removing the lower casing

- Unscrew the sealing cap (fig. 9).

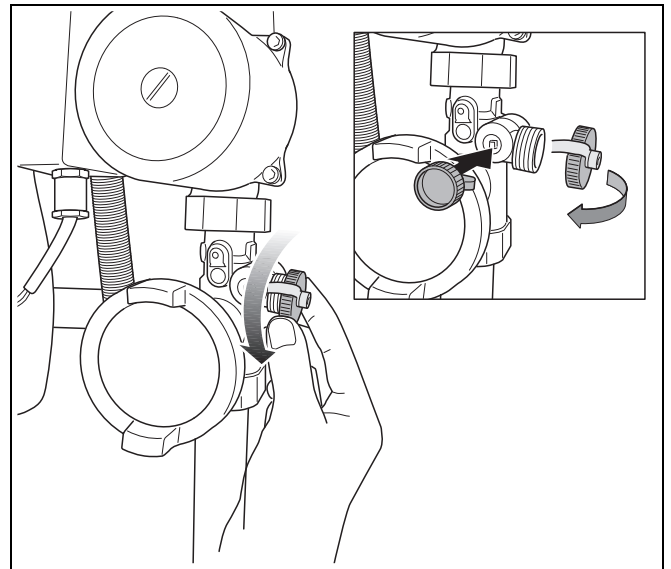

fig. 9 Removing cap from drain cock

### 5.1.1 Filling the heating system

Filling and refilling of the heating circuit must be carried out by a method that has been approved by the Water Regulation Advisory Scheme (WRAS), for the type of heating appliances, i.e. Domestic (in-house) Fluid Category 3. Non-Domestic (other than in-house) Fluid Category 4. Depending on the Fluid Category the approved method should comprise of the following:

#### Requirements Fluid Category 3 systems (fig. 10)

- Control valve (stop valve) including a double check valve on the mains cold water supply pipe.
- Temporary connection to be removed after filling (filling loop).
- Control valve (stop valve) on the heating system pipework.

#### Requirements Fluid Category 4 systems (fig. 11)

- Control valve (stop valve) on the mains cold water supply pipe.
- Strainer.
- Water non return valve with Reduced Pressure Zone (RPZ valve assembly) incorporating a Type BA air gap.
- Tundish.
- Control valve (stop valve) on the heating system pipework.

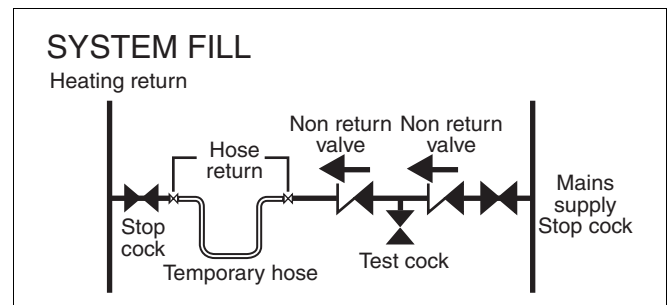

fig. 10 System fill - category 3

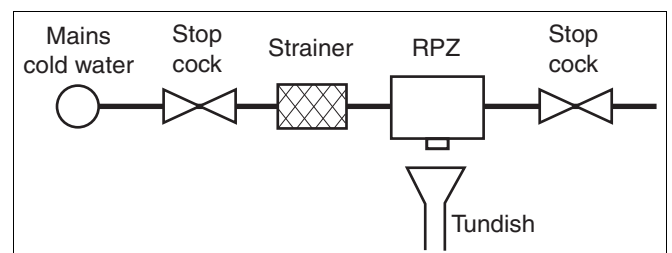

fig. 11 System fill - category 4

- Open the heating flow and return valves on the pump group (fig. 12) (open position: parallel to the pipe).

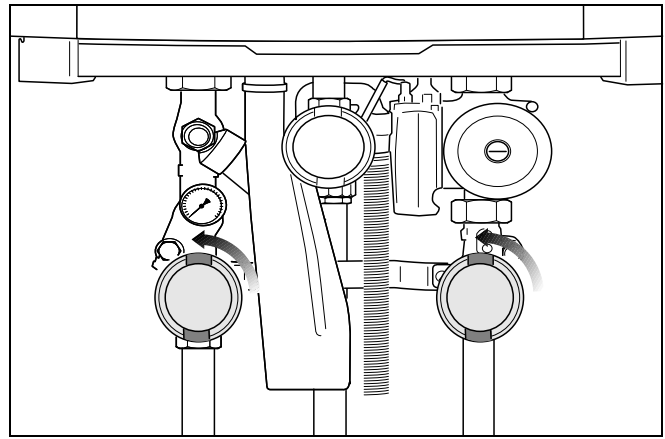

fig. 12 Opening the flow and return valves (here: open position)

- Read the pressure from the pressure gauge on the pump group or on the control panel of the BC10 (fig. 13).

The pressure in the heating system, which is measured directly at the boiler, must be at least equal to the required pre-pressure of the expansion vessel plus 0.5 bar. The minimum pressure must not be less than 1.0 bar (if the heating system is cold). The maximum pressure in the heating system, measured directly at the boiler must not exceed 2.5 bar.

- Close the water tap and drain cock.

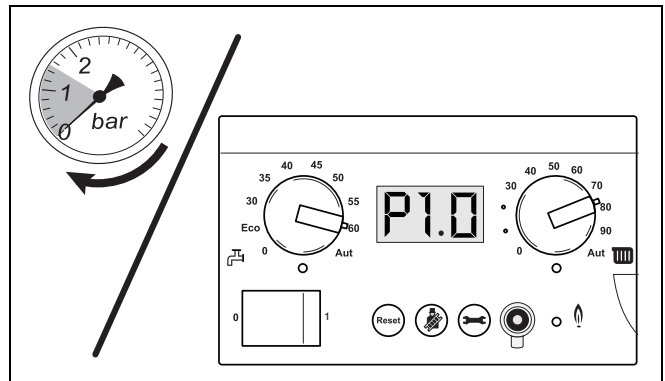

fig. 13 Reading the pressure gauge



It is very important that the heating system is now purged, since all air will collect at the highest point of the heating system when the system is slowly filled with water.

- Purge the heating system via the air vents/valves on the radiators. Start at the lower floor of the premises and then work your way up from floor to floor (fig. 14).

If the boiler has been in use for approx. one week and the pressure reading on the display is less than 1.0 bar, the system has to be topped up.

The pressure loss in a heating system is caused by air bubbles escaping via fittings and (automatic) air vents. The oxygen contained in the fresh heating water will also escape from the heating water after some time and cause the pressure in the heating system to become lower.

This explains why it is normal that the heating system has to be topped up a couple of times after commissioning it.

Eventually the system will have to be topped up on average once a year.

Should it be necessary to top up the heating system more frequently, water is probably escaping due to a leakage in the system or a defective expansion vessel. In this case the cause of the water loss must be repaired as soon as possible.

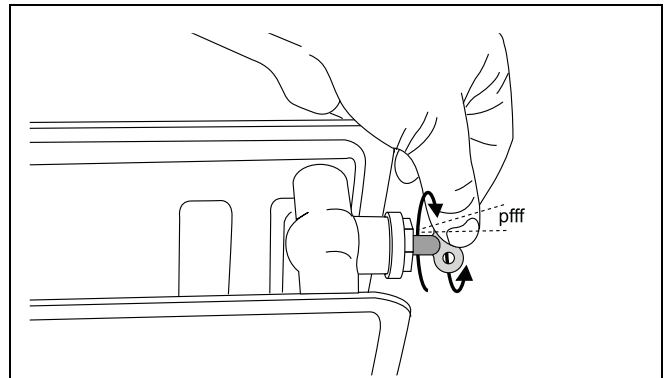

fig. 14 Purging the radiators

## 5.2 Boiler settings

Proceed as follows to complete the commissioning procedure:

- Slowly open the gas valve by pushing on the gas valve and turning it ¼ rotation in an anticlockwise direction (fig. 15). The gas valve is open when it is in its vertical position.

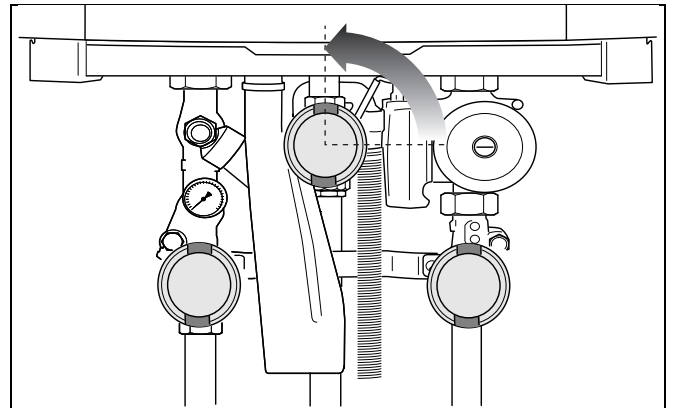

fig. 15 Opening the gas valve

- Turn both dials on the BC10 basic controller (fig. 16, **items 2 and 3**) to their required positions (→ section 5.2.1 and 5.2.2, from page 15).



If you are using a room controller both dials must be on "Aut" (automatic operation) to enable all settings to be made using the room controller.

- Switch on the mains switch (fig. 16, **item 1**) on the BC10 (position "1").

### 5.2.1 Setting the CH (boiler) flow temperature

- Set the dial for the maximum CH (boiler) flow temperature (fig. 16, **item 2**) to set the required temperature according to table 3.



If the temperature setting is too low, there is a risk that the required room temperature will not be reached.

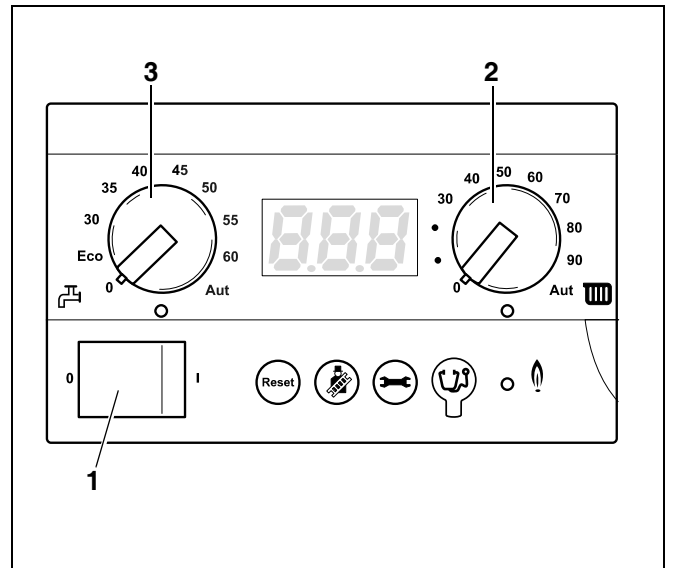

fig. 16 BC10 basic controller

Dial	Function	Settings for	Description
0	Off		No heating operation (summer)
40 °C	Required CH (boiler) flow temperature in °C	underfloor heating	Heating mode on
75 °C – 90 °C		Radiators	
90 °C		Convector	
Aut	Setting via Logamatic control (e.g. RC35/Logamatic 4121)		

table 3 CH (boiler) flow temperature

### 5.2.2 Setting the DHW temperature

The boiler is factory-set to a DHW temperature of 60 °C. This setting should prevent any legionella bacteria present in the system from propagating. However, to be able to meet the various requirements of different users, the DHW temperature of your boiler can be adjusted.

If required, the boiler can be set to a lower DHW temperature.

Please be aware that setting the boiler to a lower DHW temperature will bring a slight risk of contamination by legionella bacteria. If the DHW system is used on a daily basis, there is virtually no risk of legionella bacteria propagating.

If the DHW system is not used for a long period (e.g. during a holiday) and a temperature of less than 60 °C has been set, it is advisable to flush the hot water cylinder before using it again.

Flushing means fully opening the hot water tap for some time, so that fresh water will be supplied to the hot water cylinder. Another alternative is to set the DHW temperature dial to the 60 °C position prior to a period of absence.

- Set the DHW temperature dial (fig. 17, **item 1**) to the required temperature of the hot water in the hot water cylinder (→ table 4).

Dial position	Explanation
0	DHW mode is off (possibly only heating mode)
ECO	DO NOT use this setting!
30 – 60	The DHW temperature is set permanently on the BC10 and cannot be changed with a room controller (e. g. RC35).
Aut	The DHW temperature is set on the room controller (e. g. RC35). If no room controller is connected, 60 °C is the maximum DHW temperature.

table 4 Settings on the DHW temperature dial

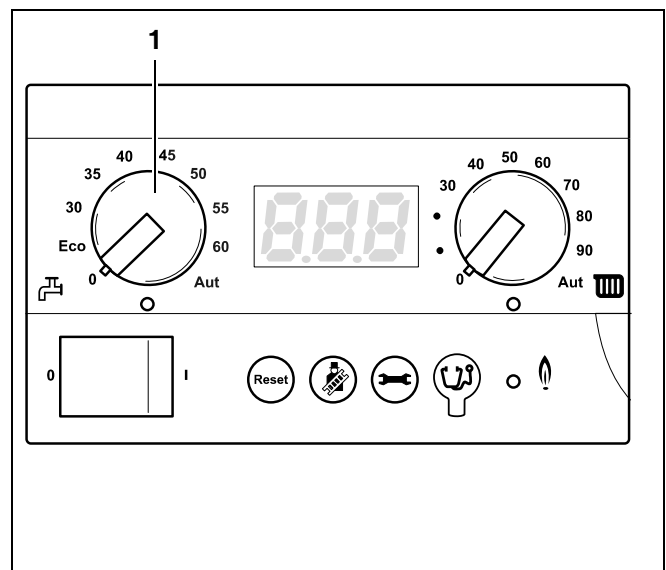

fig. 17 BC10 basic controller



### 5.2.3 Frost protection

The boiler has an integrated frost protection system. This means that no further frost protection facilities should be installed on the boiler.

The frost protection switches on the boiler at a CH (boiler) flow temperature of 7 °C and switches it off at a CH (boiler) flow temperature of 15 °C.

The heating system is not protected against frost.

### 5.2.4 Setting the room controller

- Make the settings on the room controller (e. g. RC35, → fig. 18). We advise you to check and/or set the following:
  - automatic operation mode
  - required room temperature
  - required DHW temperature
  - required heating programme.



The user manual of the room controller (e. g. RC35) describes how to make these settings and which benefits they will bring.

- You should read and observe the instructions in the room controller user manual.

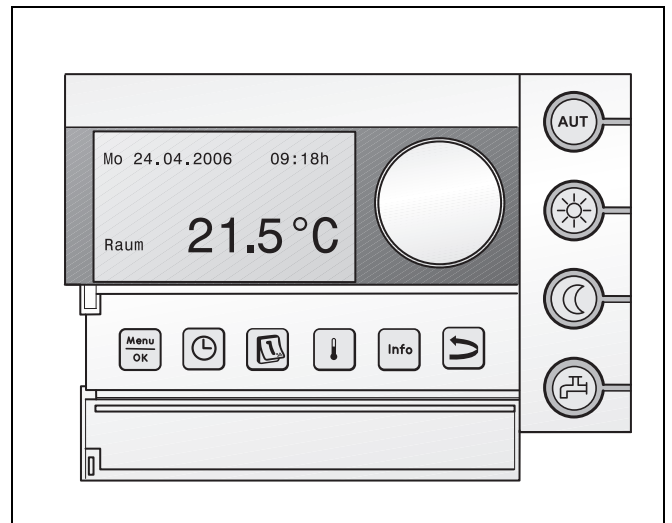

fig. 18 RC35 room controller

## 6 Operating the heating system

### 6.1 Menu structure

You can navigate through the menu structure of the central boiler on the BC10 using the "Reset" button, the "Chimney sweep" button, the "Service button" (fig. 19, **items 1, 2 and 3**) and the display (fig. 19, **item 4**) in accordance with the menus in tables 5, 6 and 7.

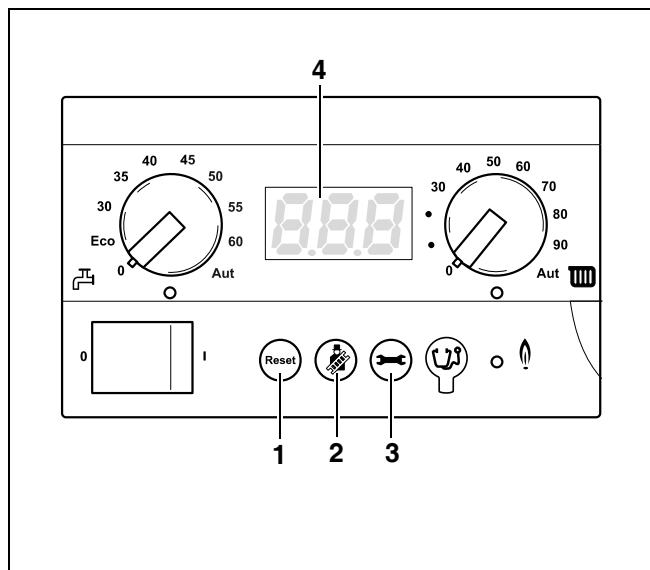

fig. 19 BC10 basic controller

#### 6.1.1 Normal Operation menu

Information about the operating status of the boiler can be displayed via this menu. The currently measured values of the CH (boiler) flow temperature (permanent indication), the working pressure and the operating codes are shown. Proceed as follows:

Normal operation menu			
<b>Step 1</b>	<input type="text" value="24"/> Display value. Currently measured CH (boiler) flow temperature in °C. Also see section 8.1, page 24.		
<b>Step 2</b>	Continue in Normal operation menu?	Yes: → step 3	No: → step 1
<b>Step 3</b>	Press the  button.		
<b>Step 4</b>	<input type="text" value="1.5"/> Display value. Currently measured system pressure in bar. Also see section 8.1, page 24.		
<b>Step 5</b>	Press the  button.		
<b>Step 6</b>	<input type="text" value="- H"/> Random display code. In this case: Operating phase: Boiler in heating mode. Also see section 8.3, page 24.		
<b>Step 7</b>	Have at least 5 seconds passed without a button being pressed and/or has the mains voltage been interrupted ?	Yes: → step 1	No: → step 8
<b>Step 8</b>	Press the  button.		→ step 1

table 5 Normal operation

### 6.1.2 Manual Operation menu

In manual mode, the heating system can be operated independent of a room controller (e. g. RC35).



- Re-start manual operation after switching on the heating system, so that the system is permanently in operation (especially if there is a risk of freezing).











Manual Operation menu			
<b>Step 1</b>	 Display value. Currently measured CH (boiler) flow temperature in °C. Also see section 8.1, page 24.		
<b>Step 2</b>	Activate manual operation?	Yes:	→ step 3
		No:	→ step 1
<b>Step 3</b>	To activate manual operation: Press and hold the  button for more than 5 seconds.		
<b>Step 4</b>	 Display code: Operating phase: As soon as a flashing dot is shown in the right-hand bottom corner of the display, manual operation is active. This means that the boiler is permanently in heating mode. The maximum CH (boiler) flow temperature as set on the maximum CH (boiler) flow temperature dial of the BC10 basic controller (control panel) now applies. The "Heat request" LED lights up. DHW mode is possible during manual operation.		
<b>Step 5</b>	Press the  button.		
<b>Step 6</b>	 Display value. Currently measured system pressure in bar. Also see section 8.1, page 24.		
<b>Step 7</b>	Press the  button.		
<b>Step 8</b>	 Display code: Operating phase: Also see section 8.3, page 24. The boiler is in manual operation mode. This means that the boiler is in heating mode while there is no heat request from the controller. During manual operation the "Settings" menu (table 7 from step 3) can be used to temporarily change the target boiler performance. <b>Note:</b> If the boiler performance has been changed temporarily, this must be set again after ending manual operation, according to the "Settings" menu (table 7, page 20).		
<b>Step 9</b>	Press the  button.		
<b>Step 10</b>	 Display value. Currently measured CH (boiler) flow temperature in °C. Also see section 8.1, page 24.		
<b>Step 11</b>	Has there been a power failure?	Yes:	→ step 1
		No:	→ step 12
<b>Step 12</b>	Deactivate manual operation?	Yes:	→ step 13
		No:	→ step 5
<b>Step 13</b>	To deactivate manual operation: Press and hold the  button for more than 2 seconds until the dot disappears.		→ step 1

table 6 Manual operation

## 6.1.3 Settings menu

Three settings can be made in the Settings menu:

- Target boiler output;
- Target pump run-over time;
- DHW mode target status.



The target boiler output and the DHW mode target status should be set by a registered installer.

If you will be absent for a long period while there is a risk of freezing, the target pump run-over time will have to be set (→ section 7.4. on page 23).

Settings menu			
<b>Step 1</b>	24	Display value. Currently measured CH (boiler) flow temperature in °C. Also see section 8.1, page 24.	
<b>Step 2</b>		Open the "Adjustments" menu?	Yes: → step 3
			No: → step 1
<b>Step 3</b>		To open the "Settings" menu: Press and hold the  +  buttons for more than 2 seconds.	
<b>Step 4</b>	--	Display setting. As soon as the display shows  --, the "Settings" menu is open. You can set the boiler output using the first parameter shown on the display (also see section 8.2, page 24).	
<b>Step 5</b>		Adjust boiler output?	Yes: → step 6
			No: → step 7
<b>Step 6</b>		<b>Lower:</b> Decrease the target boiler output with the  button. The minimum setting is  25 = 25 % with an 80-kW boiler and  20 = 20 % with a 65 and 100-kW boiler. <b>Higher:</b> Increase the target boiler output with the  button. The maximum setting is  100 = 100 %. This is equal to the factory setting.	
<b>Step 7</b>		Press the  button.	
<b>Step 8</b>	5	Display setting. Set the second parameter as soon as the display shows  5. This parameter shows the target pump run-over time in minutes after heating operation has ended (also see section 8.2, page 24). <b>Note:</b> Do not set a pump run-over time of less than  5 (= 5 minutes).	
<b>Step 9</b>		Set the pump run-over time after heating operation has ended?	Yes: → step 10
			No: → step 11
<b>Step 10</b>		<b>Lower:</b> Decrease the target pump run-over time after the end of heating operation with the  button. The minimum setting is  0 = 0 minutes. The factory default setting is 5 minutes. <b>CAUTION</b> Do not set the target pump run-over time after the end of heating operation to less than 5 minutes. <b>Higher:</b> Increase the target pump run-over time after the end of heating operation with the  button. The maximum setting is  1d = 24 hours.	
<b>Step 11</b>		Press the  button.	
<b>Step 12</b>	1	Display setting. Set the third parameter as soon as the display shows  1. This parameter indicates the DHW mode status setting. This enables DHW mode to be switched off or on. This setting has priority over other DHW mode settings, such as on the room thermostat. Also see section 8.2, page 24.	
<b>Step 13</b>		Set the DHW mode status?	Yes: → step 14
			No: → step 15

table 7 Settings







Settings menu			
<b>Step 14</b>	Set the DHW mode target status with the  or  buttons.  means "On",  means "Off". Please note: Setting  switches off the hot water cylinder frost protection.		
<b>Step 15</b>	Have at least 5 seconds passed without a button being pressed and/or has the mains voltage been interrupted ?	Yes:	→ step <b>17</b>
		No:	→ step <b>16</b>
<b>Step 16</b>	Press the  button.		
<b>Step 17</b>	 Display value. Any adjustments that you have made have been confirmed.		→ step <b>1</b>

table 7 Settings

## 7 Shutting down the heating system

### 7.1 Shutting down the heating system using the control unit

Shut down your heating system by means of the Logamatic BC10 basic controller.

Further information about the use of the Logamatic BC10 basic controller is provided in chapter 6 "Operating the heating system", page 18.

- Push on the control panel to open it (→ fig. 20).

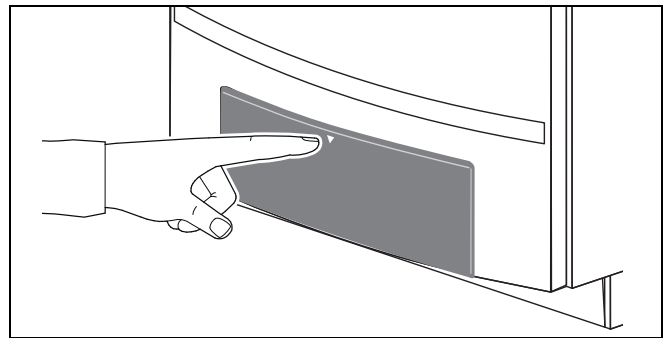

fig. 20 Opening the control panel

- Switch off the heating system by pressing the mains switch of the BC 10 (fig. 21, **item 1**).

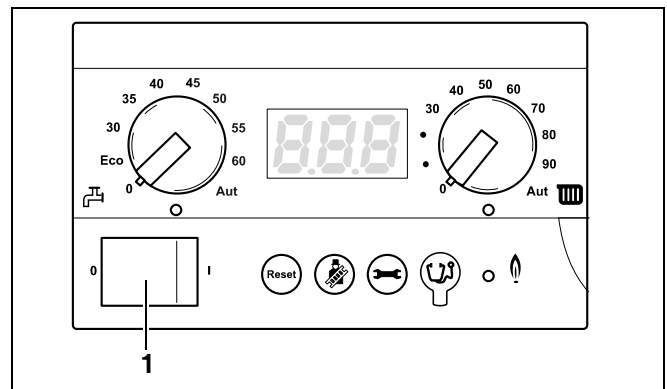

fig. 21 BC10 basic controller

- Close the main gas supply or the gas valve (→ fig. 22).

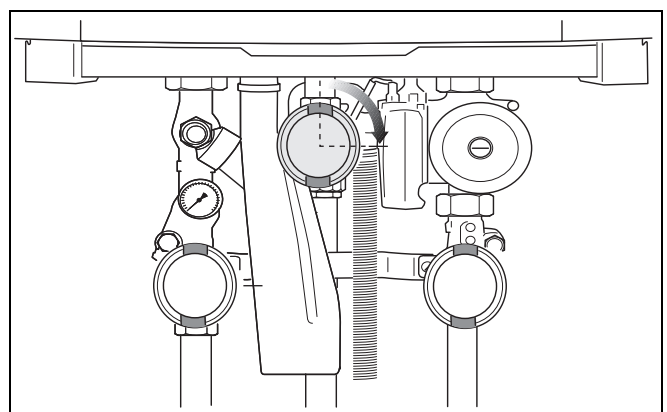

fig. 22 Closing the gas valve (here: closed)

### 7.2 Shutting down the heating system in case of an emergency

- Close the main gas supply valve!
- Switch off the power supply to the boiler by pulling the mains plug from the socket.

### 7.3 Shutting down the heating system in case of the risk of freezing (interruption of use)



#### DAMAGE TO THE INSTALLATION

due to frost.

The heating system may freeze up after some time in certain situations, e.g. after a power failure, when the supply voltage has been switched off, in case of faulty gas supply, a boiler fault etc.

- Ensure that the heating system is permanently operational (especially if there is a risk of freezing).

If conditions are such that the heating system has to be shut down for a long period while there is a risk of freezing, the water must be drained from the heating system.

- Push on the control panel to open it (→ fig. 20).
- Switch off the heating system by pressing the mains switch of the BC10 (→ fig. 21).
- Close the main gas supply or the gas valve (→ fig. 22).
- Drain the heating water at the lowest point of the heating system, using the drain cock or the radiator (fig. 23). The (automatic) air vent at the highest point of the heating system/radiator (see fig. 14, page 14) must be open then.

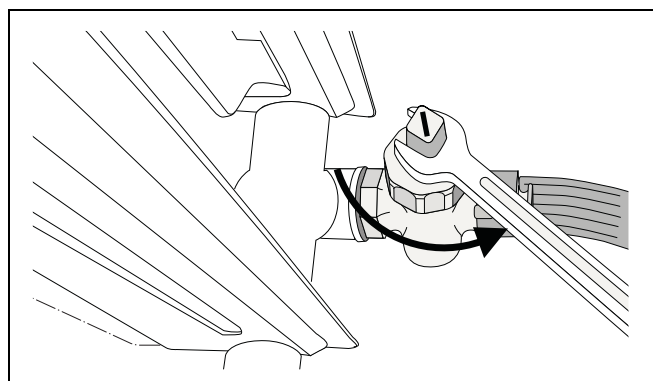

fig. 23 Draining the heating system

### 7.4 Long-term absence while there is a risk of freezing

If you would like to keep the heating system switched on:

- Leave the mains switch on the BC10 (→ fig. 21) in position "1".
- Lower the room temperature to 16 °C (→ room controller user manual).
- Set the target pump run-over time to 24 hours  according to the Settings Menu, → table 7, page 20.

## 8 Display information

### 8.1 Display readings

Display readings				
Display reading	Key to display reading	Unit	Range	
24	Current CH (boiler) flow temperature.	°C	0	-  130
P 16	Current system pressure.	bar	P 00	-  P 40

### 8.2 Display settings

Display settings				
Display setting	Meaning of display setting	Unit	Range	Factory-adjusted setting
L 99	Configured target load (100 kW).	%	L 20 -  L 99 /  L __ 100 %	L __
L 99	Configured target load (65 and 80 kW).	%	L 25 -  L 99 /  L __ 100 %	L __
F 5	Configured target value of the pump run-over time. <b>Note:</b> Do not set a pump run-over time of less than  F 5 (= 5 minutes).	min.	F 00 -  F 60 /  F 1d 24 h	F 5
E 1	DHW supply operating condition setting. <b>Please note:</b> If the setting  E 0 is displayed, the frost protection of the heat exchanger or the external hot water cylinder has also been switched off.	not applicable	E 0 „Off“ /  E 1 „On“	E 1

### 8.3 Display codes

The display shows the operating condition (e. g. a fault) by means of two three-digit codes.









































Refer to section 8.4, "Identifying and resetting faults" on page 26 for further instructions on how to remedy certain faults.

Please contact your heating engineer if you cannot remedy a fault yourself or if the display shows a code which is not listed in the table.

Footnotes with the table below:

- 1) Only visible on the Service Tool or a specific RC regulator.
- 2) Any indication with a permanent dot in the bottom right-hand corner
- 3) Any indication with a flashing dot in the bottom right-hand corner.



Display code				
 Main display code	 Sub display code		Key to display code	
				Operating phase: Communication test while starting up. This display code flashes five times within 5 seconds while starting up to indicate that the communication between the UBA 3 and the BC10 basic controller is being tested. If a new UBA 3 or a new KIM was fitted, this code will flash for max. 10 seconds.
 -R 2)	 208 1)			Operating phase: The boiler is in flue gas test or service mode.
 -H	 200 1)			Operating phase: The boiler is in heating mode.
 -H* 3)	 200 1)			Operating phase: The boiler is in manual operation mode.
 -H	 201 1)			Operating phase: The boiler is in DHW mode.
 -H	 201 1)			Operating phase: Pump run-over time via the external hot water cylinder 130 seconds at the minimum speed. The "Burner" LED (On/Off) is off.
 0A	 202 1)			Operating phase: The switch optimisation program is activated. This program is activated if there has been a DHW request from an RC regulator more frequently than once every 10 minutes. This means that the boiler cannot be restarted until at least ten minutes have elapsed since initial burner start-up.
 0A	 305 1)			Operating phase: The boiler cannot start up temporarily after a DHW request has ended.
 0C	 283 1)			Pre-operative phase: The boiler prepares for a burner start-up whenever a heat demand or a DHW request arises.
 0E	 265 1)			Readiness for operation: The boiler is in ready mode. There is a current heat demand, but too much energy has been supplied.
 0H	 203 1)			Readiness for operation: The boiler is in ready mode. There is no current heat demand.
 0L	 284 1)			Ignition phase: The gas valve is activated.
 0U	 270 1)			Start-up phase: The boiler starts up after activation of the mains power supply or completion of a system reset. This code is displayed for a maximum of 4 minutes.
 0Y	 204 1)			Operating phase: The flow temperature sensor has detected that the current flow temperature is higher than the flow temperature setting on the BC10, or that it is higher than the flow temperature. Calculated according to heating requirements, or that it is higher than the flow temperature calculated for the DHW mode.
 2E	 207			Fault: The system pressure is too low (less than 0.2 bar).
888				Function test: Display test during start-up phase. The display code is displayed for a maximum of 1 second.
 A11	 802			Fault: Time not set. Failing time setting, e.g. due to a long power cut.
 A11	 803			Fault: Date not set. Failing date setting, e.g. due to a long power cut.
				Operating phase: The system pressure is too low (less than 1.0 bar).

Display code					
Hand icon	Main display code	Hand icon	Sub display code	Hand icon	Key to display code
	H 1				Operating phase: The system pressure is too low (less than 1.0 bar).
	P - -				Operating phase: The system pressure is too high (over 4.0 bar) or the pressure sensor has not detected a system pressure (boiler functioning normally).
	r E				Fault: Reset is carried out. After pressing the "Reset" button this code is displayed for 5 seconds.

## 8.4 Identifying and resetting faults

Fault messages can be identified by the flashing display:

- Press the "Reset" button (fig. 24, **item 1**) for approx. 5 seconds to reset the fault.

The display shows . The boiler tries to reset the fault. If the display shows a normal operating code afterwards, the fault has been remedied. Otherwise, please repeat the reset two or three more times.

### If the fault cannot be reset:

- Write down the fault message and contact your heating engineer.

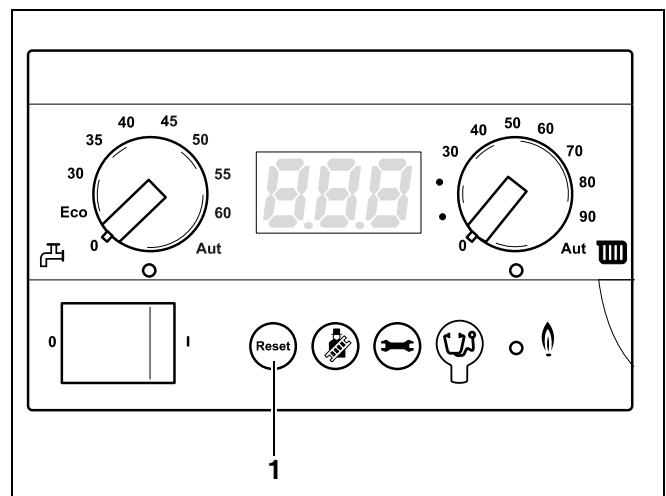

fig. 24 BC10 – "Reset" button



### DAMAGE TO THE INSTALLATION

In frost conditions, the heating system may freeze up if it is not operational, e. g. due to a power failure.

- If the heating system is switched off for a couple of days due to a fault and there is a risk of frost, the heating water must be drained at the lowest point of the system to prevent it from freezing.



**Bosch Thermotechnik GmbH**

Sophienstrasse 30-32  
D-35576 Wetzlar  
[www.buderus.de](http://www.buderus.de)  
[info@buderus.de](mailto:info@buderus.de)

**C & F Quadrant Ltd.**

Unit L40 Cherry Orchard Industrial Estate  
Cherry Orchard, Dublin 10  
Tel.: 01.6305700  
Fax: 01.6305706 / 01.6305715

[www.cfquadrant.ie](http://www.cfquadrant.ie)  
e-mail: [sales@cfquadrant.ie](mailto:sales@cfquadrant.ie)



**Buderus**

Cotswold Way, Warndon, Worcester WR4 9SW,  
Customer service: 0844 892 9700  
Technical support: 0844 892 3004  
Fax: 01905 753130  
United Kingdom

[www.buderus-commercial.co.uk](http://www.buderus-commercial.co.uk)

In the UK and IE, Buderus is a brand name of  
Bosch Thermotechnology Ltd.

**Buderus**