

Service instructions

Logamatic 4121, 4122 and 4126 control unit

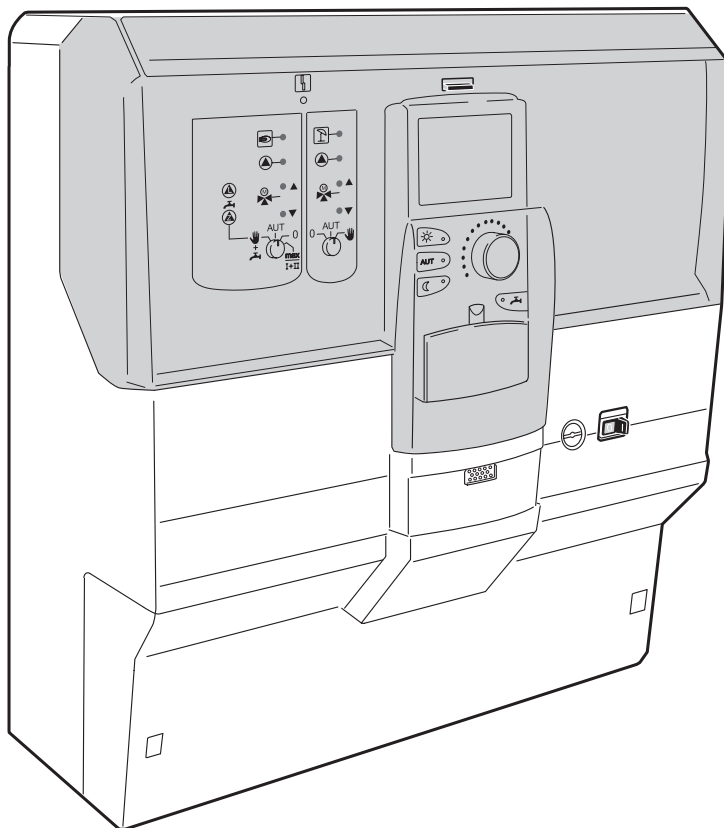

BRUNNEN

1	Safety	5
1.1	About this manual	5
1.2	Correct use	5
1.3	Please observe these notes.	5
1.4	Important notes on commissioning	5
1.5	Cleaning the control	6
1.6	Disposal	6
2	Setting parameters and display data	7
3	Logamatic 412x control unit – controls	8
4	Modules and their functions	9
5	Burner control and basic controls	22
5.1	Universal burner control (UBA 1.x)	22
5.2	BC10 (EMS) base controller	23
6	MEC 2 programmer	24
7	Commissioning the MEC 2 Programmer	25
7.1	A MEC 2 with set parameters is installed in the control unit	26
8	Calling up and modifying settings	29
8.1	Calling up the service level	29
9	General data	32
9.1	Minimum outside temperature	33
9.2	Type of construction	34
9.3	Switching the radio clock ON and OFF	35
9.4	Remote adjustment	37
9.5	Manual control fault message	38
9.6	Automatic maintenance message	39
10	Module selection	41
11	Boiler data	42
11.1	Set the number of boilers	42
11.2	Select Hydraulic design for single boiler	43
11.3	Select hydraulic design for cascade systems	45
11.4	Setting to alt. heat sources	46
11.5	Select the boiler type	47
11.6	Limit boiler output	49
11.7	Setting the maximum boiler temperature	50
11.8	Selecting the type of sequence control	51

12 Heating circuit data	53
12.1 Select the heating system	53
12.2 Rename the heating circuit	55
12.3 Set the Base point temperature	56
12.4 Set the design temperature	57
12.5 Minimum flow temperature	58
12.6 Maximum flow temperature	59
12.7 Select the remote control	60
12.8 Maximum room influence	62
12.9 Select the Setback type	63
12.10 Set the Outdoor setback temperature	65
12.11 Setting system flow reduction	66
12.12 Room temperature offset	67
12.13 Automatic correction	68
12.14 Set switching optimisation	69
12.15 Set switch off optimisation time	71
12.16 Set the frost protection temperature	73
12.17 Set DHW priority	74
12.18 Input heating circuit mixing valve	75
12.19 Enter valve running time	76
12.20 Increasing boiler temperature	77
12.21 Screed drying under floor heating	78
13 DHW data	85
13.1 Select DHW cylinder	85
13.2 Set temperature range	86
13.3 Select switching optimisation	87
13.4 Heat over run to DHW cylinder	88
13.5 Set hysteresis	90
13.6 Select the primary LAP circuit (currently not available in the UK)	93
13.7 Increase boiler temperature	96
13.8 External fault indication (WF1/WF2)	97
13.9 External contact (WF1/WF3)	98
13.10 Selection and set up of thermal disinfection	100
13.11 Select the circulation pump	105
13.12 Switching off the DHW circulation pump during DHW loading	107

14 Heating Parameters	108
15 Testing the relay	109
16 Carrying out an LCD test	111
17 Error	112
17.1 Fault displays	113
17.2 Supplementary fault messages for boilers with EMS	117
17.3 Maintenance messages on boilers with EMS (only Oil)	119
18 Low loss header monitor data	121
18.1 Low loss header monitor data	121
18.2 Boiler monitor data	122
18.3 Heating circuit monitor data	125
18.4 DHW monitor data	127
19 Display version	129
20 Selecting the control unit	130
21 Reset	131
21.1 Resetting control unit parameters	131
21.2 Reset the error	132
21.3 Resetting the maintenance message	133
22 Sensor curves	134
22.1 Sensor curves	134
22.2 Heating curves	136
23 Keyword Index	137

1 Safety

1.1 About this manual

These service instructions contain important information on the safe and appropriate commissioning and servicing of the Logamatic 4121, 4122 and 4126 control panels.

These service instructions are designed for installers who, due to their training and experience, are familiar with heating systems and water installations. Only carry out this service work if you possess these skills.

- Explain to the customer the function and operation of the related units.

1.2 Correct use

The Logamatic 4121, 4122 and 4126 control panels are only intended to control heating systems in houses, larger houses, apartments and commercial properties.

1.3 Please observe these notes

- Only operate the control panels as intended and only if they are in perfect working order.
- Carefully read these service instructions before commencing any work on the control panel.



RISK TO LIFE

from electric shock.

WARNING!

- Make sure that any electrical work is only carried out by authorised, trained personnel.
- Before opening the control panel: Isolate all poles of the control panel and secure against unauthorised re-connection.



SYSTEM DAMAGE

through frost.

CAUTION!

The heating system can freeze up in cold weather if it has been switched off.

- Protect your heating system against freezing by draining the heating system and domestic hot water (DHW) pipe-work at the lowest possible point.



USER NOTE

Make sure that you have isolated the mains power supply by switching the mains off.



USER NOTE

Only use original Buderus spare parts. Losses caused by the use of parts not supplied by Buderus are excluded from the Buderus warranty.



This unit meets all requirements of relevant European standards directives and guidelines.

Its conformity has been verified. All associated documents and the original Declaration of Conformity are available from the manufacturer.

1.4 Important notes on commissioning

- Before switching the control unit ON, check that its manual switches and those on the function modules are set to AUT (automatic).
- A setting record is provided as an information base for the system user in the operating instructions of the control panel. During commissioning, make a note in this record of all settings and heating circuit selected.

Switching ON: First switch ON the control panel and then the boiler.

Switching OFF: First switch OFF the boiler and then the control panel.

- Please ensure that the heat is transferred from the heat exchanger, otherwise the boiler will switch OFF and generate an error condition.

1.5 Cleaning the control

- The control should only be cleaned with a damp cloth.

1.6 Disposal

- Dispose of the control panel packaging in an environmentally responsible manner.
- Dispose of old control panels in an environmentally responsible manner through an approved organisation. When disposing of the panel, remove the lithium battery (which is on the CM431 module) from the control panel and dispose of separately. This should be removed by your installer.

2 Setting parameters and display data

Some options are only displayed with certain modules and depending on prior settings.

<ul style="list-style-type: none"> General data <ul style="list-style-type: none"> — Min outdoor temp. — Type of building — Clock ac. — Remote adjustment — Manual control fault message — Automatic maintenance message Module selection <ul style="list-style-type: none"> — Pos. A — Pos. 1 — Pos. 2 Boiler data <ul style="list-style-type: none"> — Number of boilers — Hydraulic — External heat source — Boiler type — Boiler output — Max. boiler temp. — Cascade mode (in service or parallel) Heating circ 1 <ul style="list-style-type: none"> — Heating system — "Heat circ desc." — Base point temperature — Design temperature — Min. flow temp. — Max. flow temp. — Remote control — Max. room influence — Setback type — Outdoor temperature — Flow temp reduction — Room temperature offset — Automatic correction — Switching optimisation — Frost prot from — DHW priority — Valve — Valve running time — Increasing boil. temp. — External day/night/auto — Scree drying (underfloor heating) — Cement temperature rise — Cement heat-up time — Max. cement temp. — Cement temp. holding time — Cement setback temperature — Cement setback time 	<ul style="list-style-type: none"> Heating circ. 2, see Heating circ. 1 DHW <ul style="list-style-type: none"> — DHW — Range in Deg — Switching optimisation — Rest heat use — Hysteresis — Switch-OFF hysteresis — Switch-ON hysteresis — LAP primary — Boiler increase — External fault message WF1/2 — External contact WF1/3 — Thermal disinfection — Disinfection temperature — Disinfection weekday — Disinfection time — DHW circulation pump — DHW circulat per hour — Circulation off during DHW loading Heating curves <ul style="list-style-type: none"> — Heating circ 1 — Heating circ 2 Relay test <ul style="list-style-type: none"> — Heating circ 1 — Heating circ 2 — DHW — Cascade LCD test Error Monitor <ul style="list-style-type: none"> — Low loss header — Boiler 1 — Heating circ 1 — Heating circ 2 — DHW Version Control panel Reset <ul style="list-style-type: none"> — Control unit settings — Error — Consumption usage — Maintenance message
---------------------------------------------------------------------------------------------------------------------------------------------------------------------------------------------------------------------------------------------------------------------------------------------------------------------------------------------------------------------------------------------------------------------------------------------------------------------------------------------------------------------------------------------------------------------------------------------------------------------------------------------------------------------------------------------------------------------------------------------------------------------------------------------------------------------------------------------------------------------------------------------------------------------------------------------------------------------------------------------------------------------------------------------------------------------------------------------------------------------------------------------------------------------------------------------------------------------------------------------------------------------------------------------------------------------------------------------------------------------------------------------------------------------------------------------------------------------------------------------------------------------------------------------------------------------------------------------------------------------------------------------------------------------------	-------------------------------------------------------------------------------------------------------------------------------------------------------------------------------------------------------------------------------------------------------------------------------------------------------------------------------------------------------------------------------------------------------------------------------------------------------------------------------------------------------------------------------------------------------------------------------------------------------------------------------------------------------------------------------------------------------------------------------------------------------------------------------------------------------------------------------------------------------------------------------------------------------------------------------------------------------------------------------------------------------------------------------------------------------------------------------------------------------------------------------------------------------------------------------------------------------------------------------------------------------------------------------------------------------------------------------------------------------------------------------------------------------------------------------------------------------------------------------------------------

Fig. 1 Parameters and display data

3 Logamatic 412x control unit – controls

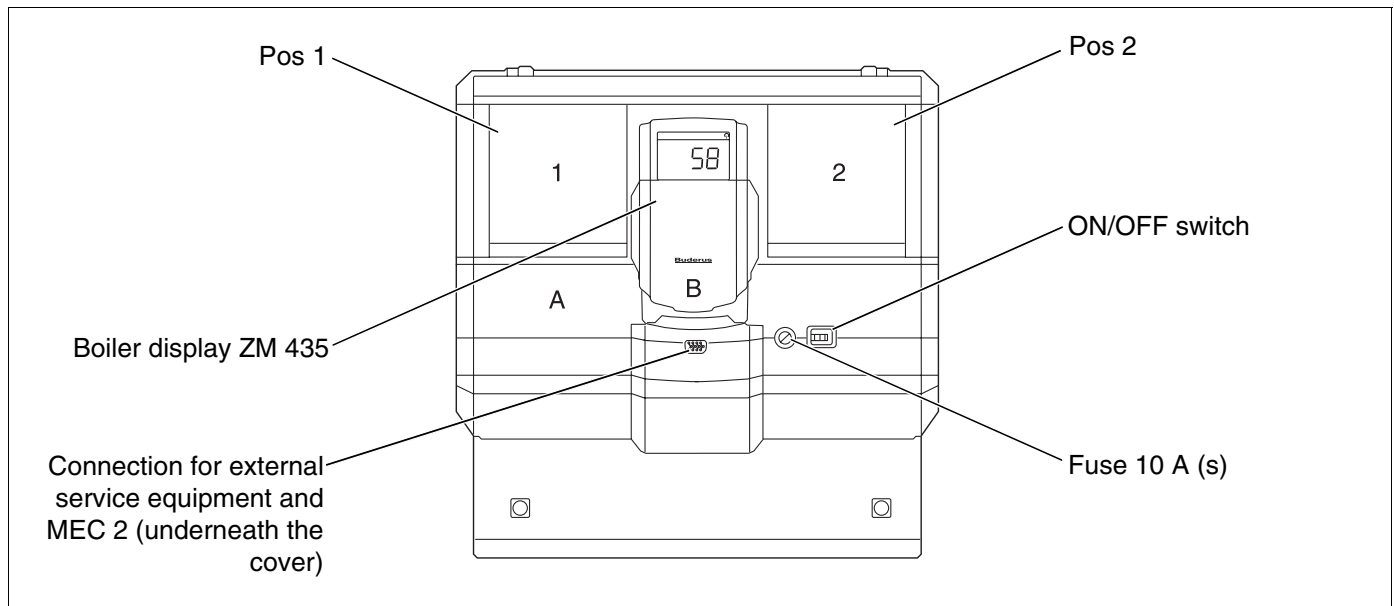

Fig. 2 Controls (Logamatic 4122 as example)



USER NOTE

The Logamatic 4122 control unit can also be supplied with the MEC 2.



USER NOTE

The system flow temperature is displayed on the boiler display.

Example of inserted modules

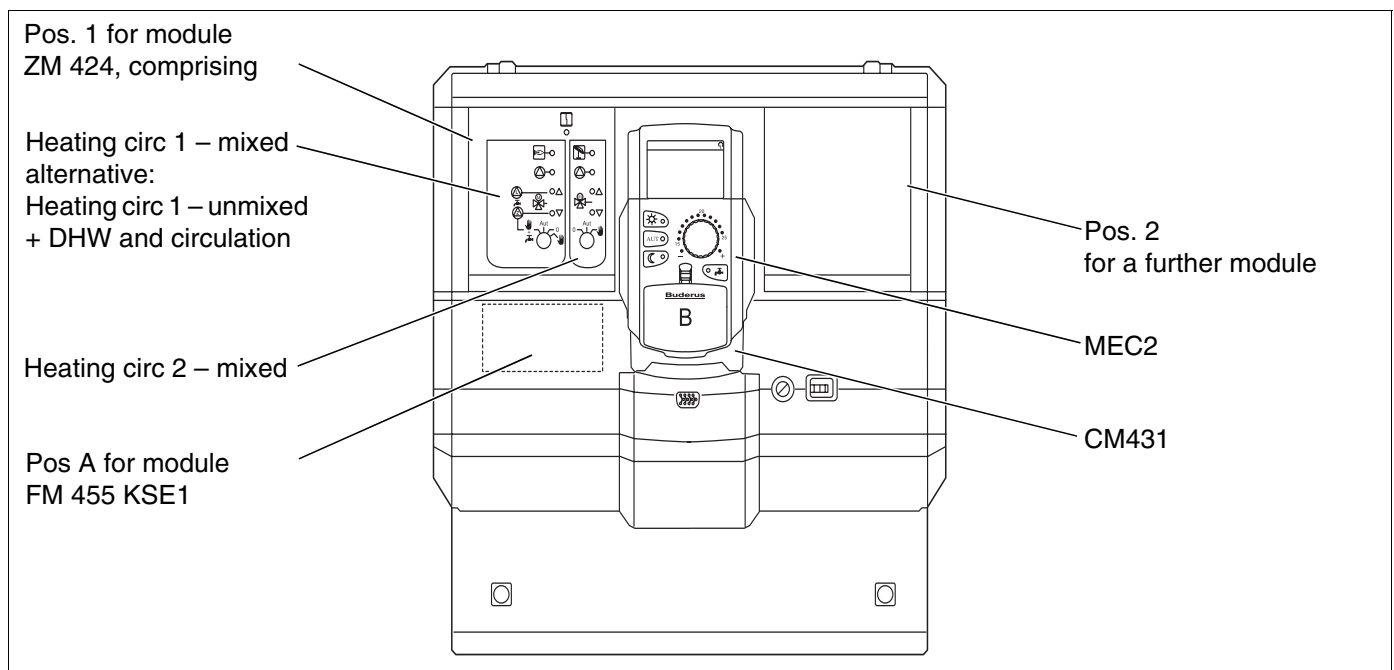

Fig. 3 Inserted modules (Logamatic 4121 as example)

4 Modules and their functions

All modules which are or can be fitted into your Logamatic 41xx control unit are shown here.

Module	Logamatic		
	4121	4122	4126
MEC 2 programming unit	O	●	O
Boiler display ZM 435	X	●	X
Controller module CM 431	O	O	O
Central module ZM 424 2 heating circuits + 1 DHW circuit	O	–	–
Function module FM 441 1 heating circuit + 1 DHW circuit	–	X	–
Function module FM 442 2 heating circuits	X	X	–
Function module FM 443 Solar heating circuit*	X	X	–
Function module FM 445 LAP/LSP (loading system)*	X	X	O
Function module FM 446 Interface EIB*	X	X	X
Function module FM 448 Central fault message	X	X	X
Function module FM 455 KSE 1 (only with ZM 424)*	O	–	–
Function module FM 456 KSE 2 (cascade - 2 boilers)	X	X	X
Function module FM 457 KSE 4 (cascade – 4 boilers)	X	X	X

Tab. 1 Modules and their functions

- O = Basic equipment
- = Subject to version, either a MEC 2 or a boiler display ZM 435 may be fitted as standard equipment.
- X = Optional equipment
- = Combination not possible

* Not currently available in the UK and Eire.



USER NOTE

The menus displayed on the MEC 2 depend on which modules are fitted and on their respective settings.

The following pages contain information as to the most important modules you can use.

The FM 443, FM 446 and FM 448 technical modules are described separately in the respective module documentation.

Module CM 431

Setting the control unit address for cascade systems

You can set the address on the Logamatic control unit behind the MEC 2 on module CM 431.

- Remove the MEC 2.
 - Set the address number with a screwdriver. Each address must only be used once. A fault message is displayed if the same address is set more than once.
- 1 control unit
setting: factory setting = address 0
 - 2 control units
setting for control unit 1: address 1
Module ZM 424 or FM 456 / FM 457 must be fitted into control unit 1 (master).
setting for control unit 2: address 2 (substation)
 - 3 control units
setting for control unit 1: address 1
Module ZM 424 or FM 456 / FM 457 must be fitted into control unit 1 (master).
setting for control unit 2: address 2 (substation)
setting for control unit 3: address 3 (substation)
 - Maximum settings: 15 addresses



USER NOTE

The boiler must be controlled by the control unit with address 1.

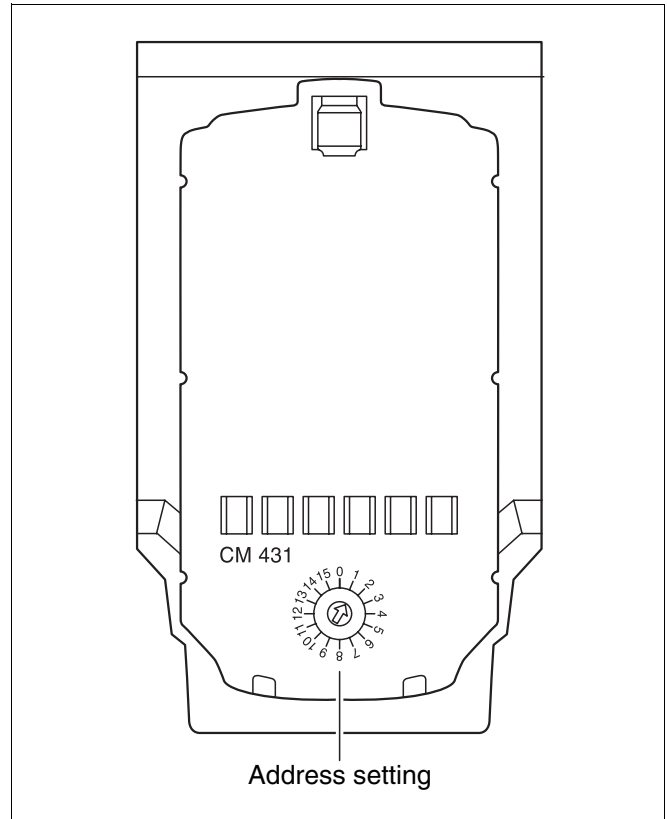

Fig. 4 Setting an address

Control units networked by an ECOCAN BUS.

There must only be one master control unit (lead control unit) if several control units are operated in an ECOCAN BUS network. All other networked control units are slaves.

Master (lead control unit)

The master control unit always controls the boiler, in other words, this control unit is always equipped with the boiler modules (ZM 424, FM 455, FM 456 or FM 457).

Set the master to control unit address 1.

Always connect the outdoor sensor to the master control unit. The master control monitors the ECOCAN BUS. It recognises, for example, if one address is allocated more than once. The master control unit collects the settings for all of control units in the network and creates an overall setting.

Slaves (subordinate control units)

All other controls in the ECOCAN BUS network are slaves (subordinate control units). None may ever have address 1. The slave control must all have different addresses > 1.

Each address must only be allocated once.

Shutting down the control units



CAUTION High Voltage!

WARNING!

Make sure that you have isolated the mains power supply by switching the mains off.

To ensure fault free data transmission between several controls, fit a resistor to the two control units which are furthest apart from each other.

In the case of several controls being used, fit the resistor in both controls at the extremities of the chain.

The resistor is located at the rear of the power supply module NM 482 and is switched ON with a gravity switch.

The factory setting is:

gravity switch S1 open = resistor not fitted.

Resistor example on substations

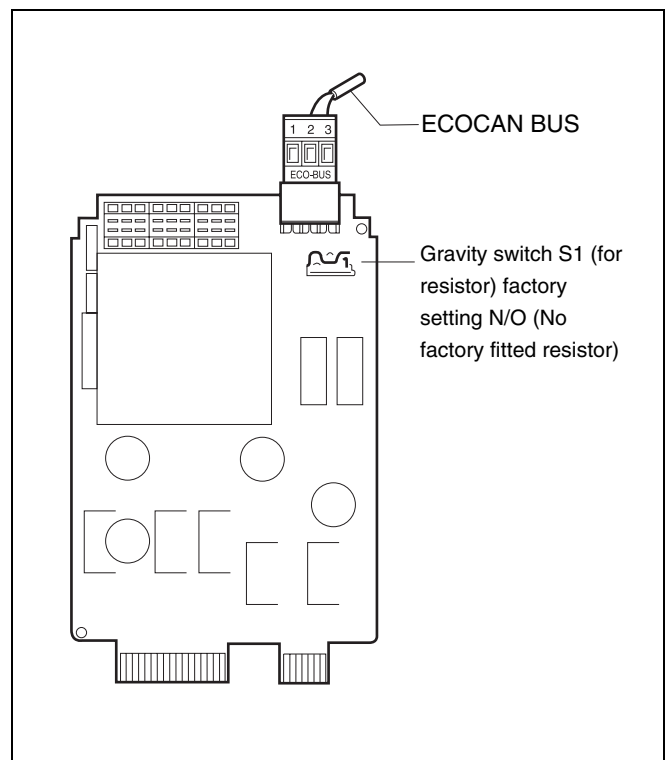
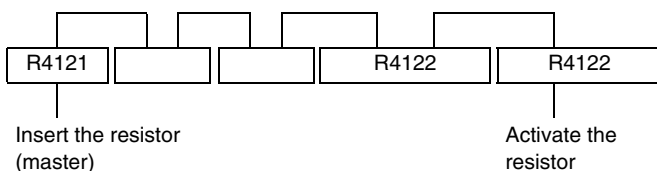



Fig. 5 Installing the resistor

Central module ZM 424

The module ZM 424, together with module FM 455 is part of the basic equipment of the **Logamatic 4121 control unit**.

Module ZM 424 must always be positioned in the l.h. slot 1. Module FM 455 must always be positioned below the ZM 424 in slot A.

The manual switches on the module only have service and maintenance functions and only affect the 230 V outputs.

If the manual switches are not set to Auto, a corresponding message appears on the MEC 2 and the fault indicator  illuminates.

Use the holiday function for this purpose (see operating instructions for Logamatic 4121, 4122 and 4126).

The control functions continue to operate in manual mode.

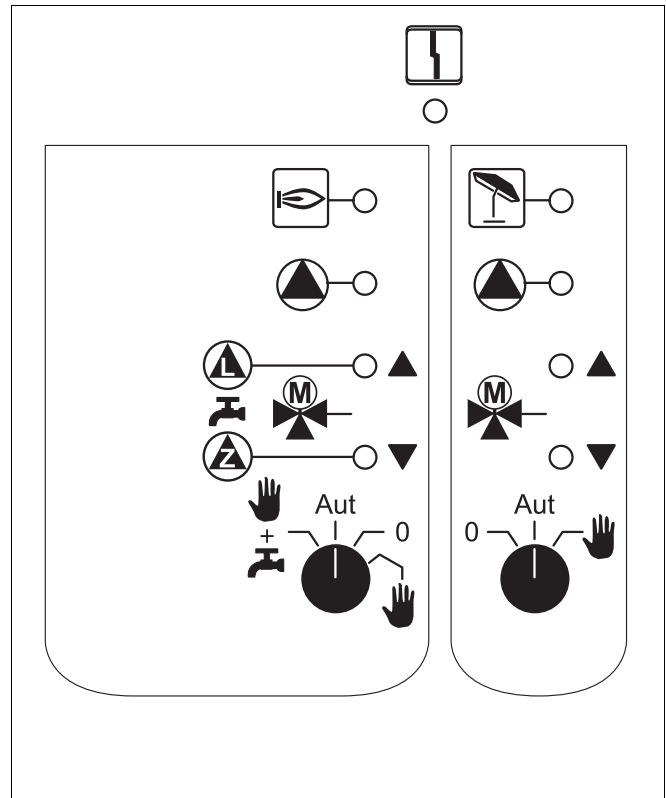









Fig. 6 ZM424

Display  General fault, e.g. site error, sensor error, external faults, internal wiring fault module error, manual mode.
The fault messages appear as plain text in the MEC 2.

Indicators for the following functions:

- Display  Operational burner
- Display  "3 way mixing valve opens" (hotter)
- Display  "3 way mixing valve closes" (colder)
- Display  Heating 2 circuit in summer mode
- Display  Heating circuit pump operational
- Display  DHW Cylinder load pump active
- Display  DHW circulation pump active

Heating circuit and hot water function

Manual switch heating circuit and DHW

for heating circuit 1:

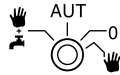

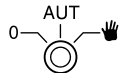

for heating circuit 2:



USER NOTE

In standard mode, set the manual switch to "AUT".

The positions **0** and **manual** (hand icon) are special settings reserved for installer only.

-  The heating circuit pump is switched ON.
The mixing valve is switched volt-free and can be manually operated.
- AUT The central heating or the Domestic hot water (DHW) circuit operates in automatic mode.
- 0 The heating circuit pump or the DHW cylinder load pump as well as the DHW circulation pump are switched OFF.
The mixing valve is switched volt-free.
The control functions continue to operate.
-  The heating circuit pump and the load pump are switched ON if "4000 cylinder" has been set in the "DHW" menu (see page 86).

Current functions are indicated by LED's.

Function module FM 441

The module FM 441 controls a heating circuit and a DHW supply.

The manual switches on the module only have service and maintenance functions and only affect the 230 V outputs.

Only fit this module into the Logamatic 4122 control unit.

If the manual switches are not set to Auto, a corresponding message appears on the MEC 2 and the fault indicator  illuminates.

Never use the manual switches to switch OFF the system when you have to temporarily leave the installation.

Use the holiday function for this purpose (see operating instructions for Logamatic 4121, 4122 and 4126).

The control functions continue to operate in manual mode.

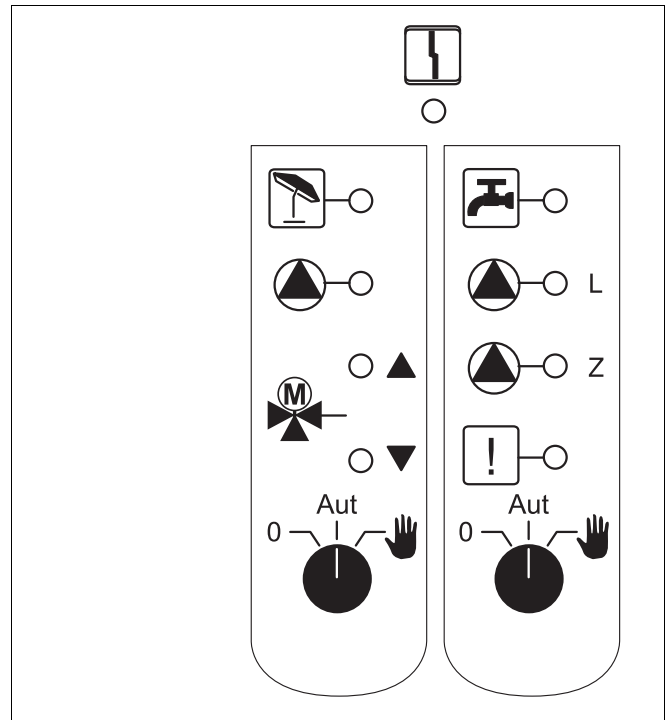











Fig. 7 FM441

Display  General fault, e.g. site error, sensor error, external faults, internal wiring fault module error, manual mode.
The fault messages appear as plain text in the MEC 2.

Indicators for the following functions:

- Display  "3 way mixing valve opens" (hotter)
- Display  "3 way mixing valve closes" (colder)
- Display  Heating circuit in summer mode
- Display  DHW is/remains below the set temperature in setback night mode
- Display  Heating circuit pump operational
- Display  DHW Cylinder load pump active
- Display  DHW circulation pump active
- Display  Thermal disinfection

Heating circuit and hot water function

Manual switch heating circuit and DHW

for heating circuit 1:

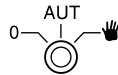

for DHW flow:

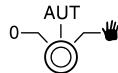

USER NOTE

In standard mode, set the manual switch to "AUT".

The positions **0** and **manual** (hand icon) are special settings reserved for qualified personnel only.

- hand icon** The heating circuit pump or the DHW cylinder load pump will be switched ON.
The mixing valve is switched volt-free and can be manually operated.
- AUT** The central heating or the DHW circuit operates in automatic mode.
- 0** Only the heating circuit pump or the DHW cylinder load pump, as well as the DHW circulation pump are switched OFF.
The mixing valve is switched volt-free.
The control functions continue to operate.

Current functions are indicated by LED's.

Function module FM 442

The module FM 442 controls two independent heating circuits with valve.

Two modules of this type can be utilised in one control unit.

The manual switches on the module only have service and maintenance functions and only affect the 230 V outputs.

If the manual switches are not set to Auto, a corresponding message appears on the MEC 2 and the fault indicator  illuminates.

Never use the manual switches to switch OFF the system when you have to temporarily leave the installation.

Use the holiday function for this purpose (see operating instructions for Logamatic 4121, 4122 and 4126).

The control functions continue to operate in manual mode.

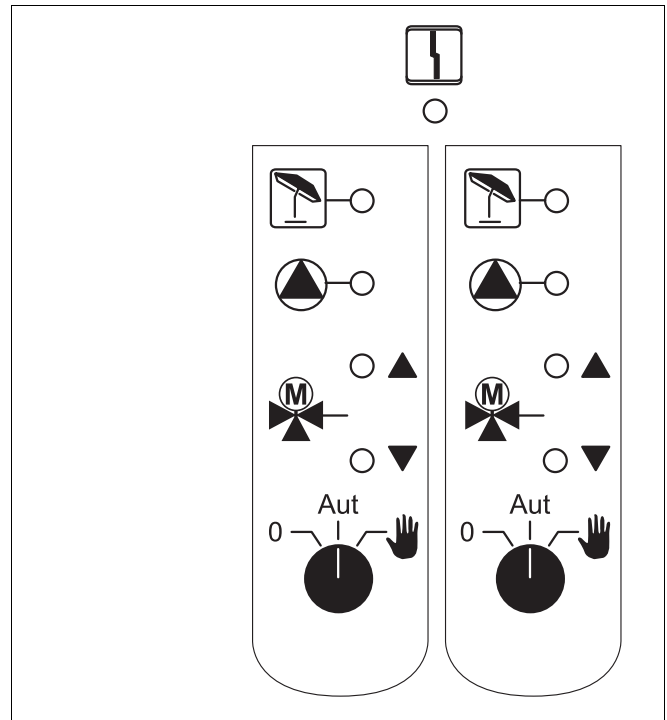







Fig. 8 FM442

Display  General fault, e.g. site error, sensor error, external faults, internal wiring fault module error, manual mode.
The fault messages appear as plain text in the MEC 2.

Indicators for the following functions:

- Display  "3 way mixing valve opens" (hotter)
- Display  "3 way mixing valve closes" (colder)
- Display  Heating circuit in summer mode
- Display  Heating circuit pump operational

Heating circuit function

Manual switch – heating circuit

for heating circuit 1 and heating circuit 2:

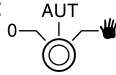

USER NOTE

In standard mode, set the manual switch to "AUT".

The positions **0** and **manual** (hand icon) are special settings reserved for installer only.

-  The heating circuit pump is switched ON.
The valve is switched volt-free and can be manually operated.
- AUT The heating circuit operates in automatic mode.
- 0 Only the heating circuit pump is switched OFF.
The valve is switched volt-free.
The control functions continue to operate.

Current functions are indicated by LED's.

Function module FM 445 - currently not available in the UK

The module FM 445 controls the DHW flow via an external heat exchanger.

Plug into the r.h. slot (slot 2) of the control unit; this ensures the power supply to all other modules. You can only use this module if no other FM 441 has already been installed in the control unit.

The manual switches on the module only have service and maintenance functions and only affect the 230 V outputs.

If the manual switches are not set to Auto, a corresponding message appears on the MEC 2 and the fault indicator  illuminates.

Never use the manual switches to switch OFF the system when you have to temporarily leave the installation.

Use the holiday function for this purpose (see operating instructions for Logamatic 4121, 4122 and 4126).

The control functions continue to operate in manual mode.

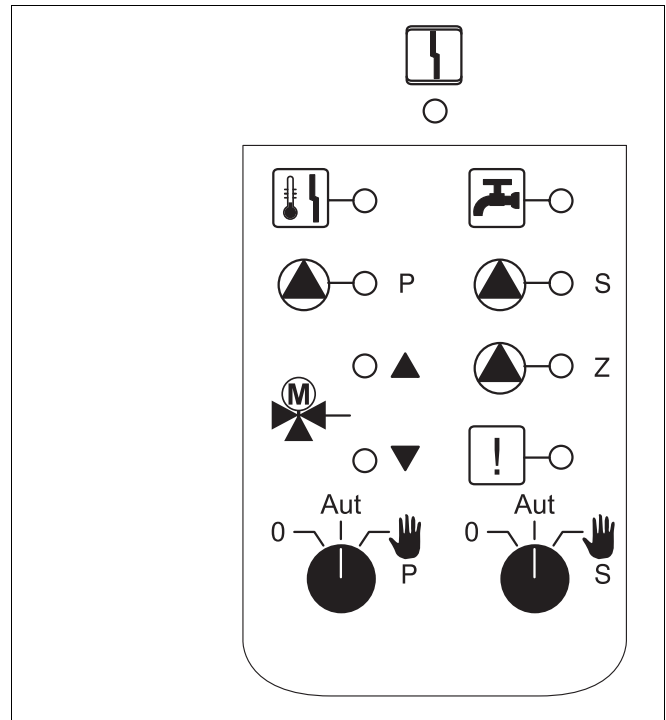











Fig. 9 FM445

Display  General fault, e.g. site error, sensor error, external faults, internal wiring fault module error, manual mode.
The fault messages appear as plain text in the MEC 2.

Indicators for the following functions:

- Display  DHW is/remains below the set temperature in reduced night mode
- Display  " 3 way mixing valve opens" (hotter)
- Display  " 3 way mixing valve closes" (colder)
- Display  - P Primary cylinder charge pump active
- Display  - S Secondary cylinder charge pump active
- Display  - Z DHW circulation pump active
- Display  Thermal disinfection
- Display  Anti-scaling protection active, secondary pump cycles

DHW function

Manual DHW switch

for primary circuit:

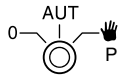

for secondary circuit:

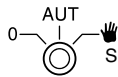

USER NOTE

In standard mode, set the manual switch to "AUT".



WARNING!

RISK OF SCALDING

In the manual mode you are at risk from scalding. Always open the cold water tap and mix with hot water according to your requirements.

The positions **0** and **manual** (hand icon) are special settings reserved for installers only.

-  The secondary/primary pump is switched ON. The valve is switched volt-free and can be manually operated.
- AUT** The DHW charging system operates in automatic mode.
- 0** The primary, secondary and DHW circulation pump are switched OFF. The valve is switched volt-free. The control functions continue to operate.

Current functions are indicated by LED's.

Function modules FM 456 and FM 457

A number of Buderus wall-mounted boilers with UBA 1.x or MS/UBA3 can be controlled using these KSE modules (FM456: up to 2 boilers; FM457: up to 4 boilers). These wall-mounted boilers may have different outputs.

Two of these modules may be fitted in the Logamatic 4122 control unit (for information on the ECOCAN BUS network of control units with FM456/FM457 see chapter Modules, CM 431).

Other module functions are:

The FM456 or FM457 are equipped with a heating circuit without a valve. You cannot connect a remote control unit for this heating circuit. The pump for this heating circuit is connected via the 230 V pump output.

The outdoor sensor or boiler sensor for this model is only activated if it is the first model (viewed from the left) with an outdoor or boiler sensor.

The 0 – 10 V input enables an external set point link. A voltage of 10 V on this input represents 90 °C. A voltage of 0.6 V on this input represents 10 °C (Fig. 11). This is a linear function.

Output for multiple fault messages:

All control unit faults cause this output to be switched. A lamp may, for example, be switched ON via the volt-free contacts of this output.

The manual switches on the modules, only have service and maintenance functions, and affect only the 230 V outputs.

If the manual switches are not set to Auto, a corresponding message appears on the MEC 2 and the fault indicator  illuminates.

Never use the manual switches to switch OFF the system when you have to temporarily leave the installation.

Use the holiday function for this purpose (see operating instructions for Logamatic 4121, 4122 and 4126).

The control functions continue to operate in manual mode.

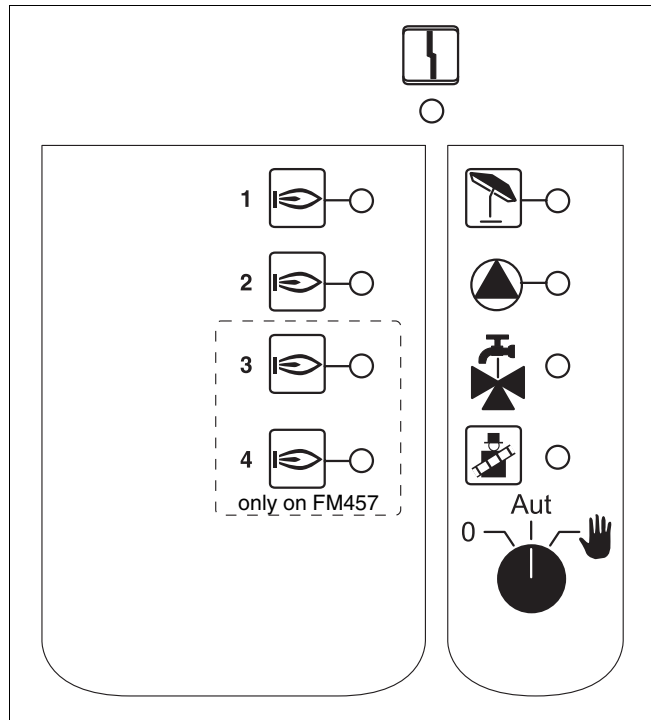







Fig. 10 FM457

Display  General fault, e.g. site error, sensor error, external faults, internal wiring fault module error, manual mode.
The fault messages appear as plain text in the MEC 2.

Indicators for the following functions:

- Display  Operational burner
- Display  Heating circuit without valve in summer mode
- Display  Heating circuit pump active
- Display  DHW operates via wall-mounted boiler
- Display  Boiler in flue gas test mode

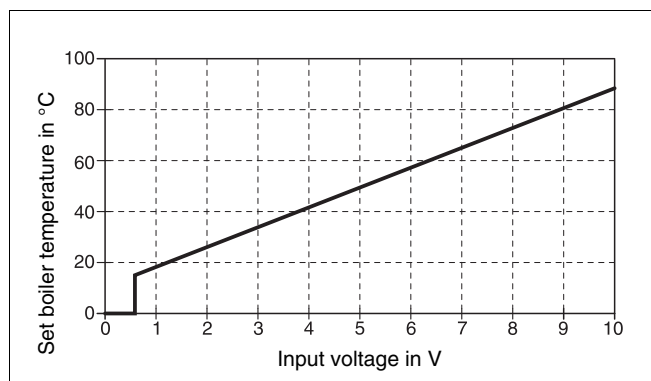
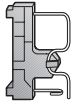



Fig. 11 Input 0 - 10V

Jumper block

The module is configured using the jumper block:

Setting		Function
	open (factory setting)	The module is registered as a new FM455/456/457 module
	closed	The module is registered as FM451/452/454. Only required if the module is used as replacement part.



USER NOTE

If used with EMS, the jumper block must be open.

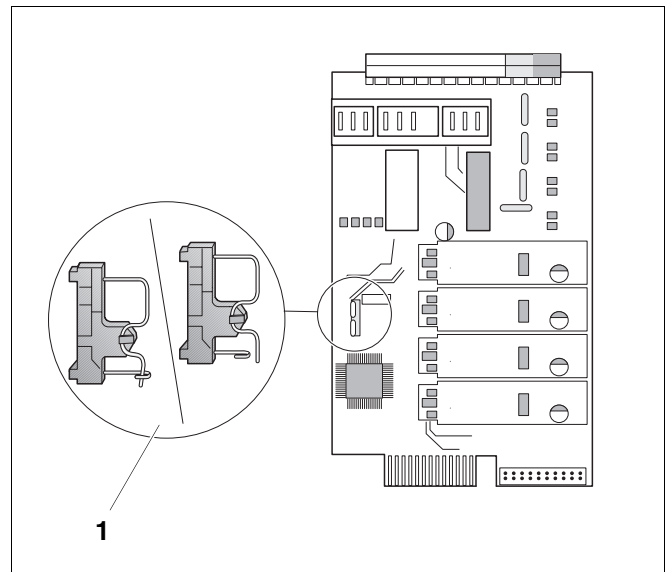
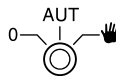

Fig. 12 Jumper block (e.g. FM457)

Heating circuit function

Manual switch – heating circuit

for heating circuit:



USER NOTE

In standard mode, set the manual switch to "AUT".

The positions **0** and **manual** (hand icon) are special settings reserved for installers only.

-  The heating circuit pump is switched ON.
- AUT The heating circuit operates in automatic mode.
- 0 The heating circuit pump is switched OFF.
The control functions continue to operate.

Current functions are indicated by LED's.

5 Burner control and basic controls

Buderus wall-mounted boilers are fitted with a UBA 1.x or UBA 3 universal burner control. The UBA 1.x is equipped with an independent programming unit.

As with floor-standing boilers with EMS (Energy Management System), wall-mounted boilers with UBA 3 are operated the same via the BC10 base controller.

The table on the right you can see the description of boiler types and burner control units.

See page 94 for all the individual boiler types.

	Wall-mounted boiler without EMS	Wall-mounted boiler with EMS	Floor-standing boiler with EMS
Burner control	UBA 1.x	UBA 3	EMS burner control unit SAFE
Basic controls	UBA 1.x	BC10 base controller	
Code	"UBA"	"EMS/UBA 3"	"EMS/SAFE"

Tab. 2 Boiler type codes

5.1 Universal burner control (UBA 1.x)

The UBA 1.x is used in wall-mounted boilers which produce domestic hot water via a cylinder or an internal heat exchanger (combination boilers).

You can set both functions via the MEC2.

During normal operation (using the MEC2), setting the boiler water temperature on the UBA would be ineffective. If, however, the communication with the control panel is interrupted, the UBA returns to the temperature setting on the boiler water thermostat (see Fig. 13).

Therefore, select the thermostat setting so that neither the heating circuit nor the DHW overheat if an error occurs (see technical documentation for the UBA).

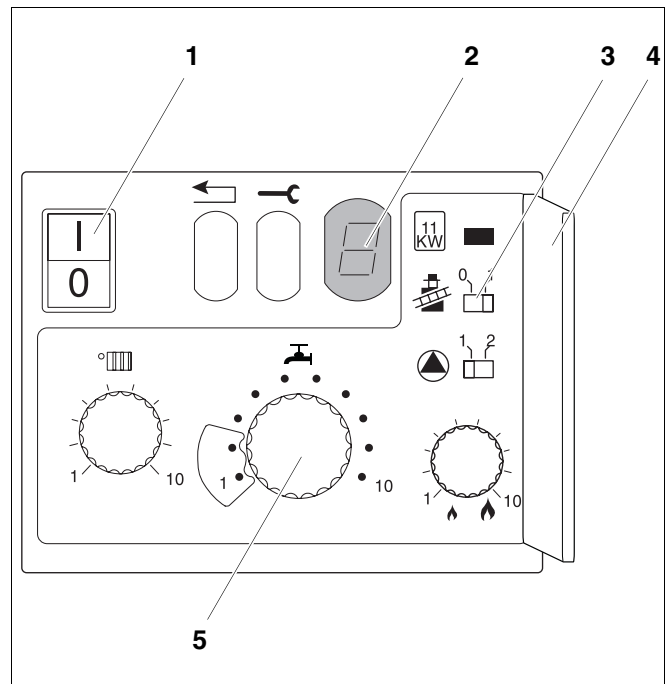

Fig. 13 UBA 1.x controls

- Item 1:** ON/OFF switch
- Item 2:** Display
- Item 3:** Emissions test switch
- Item 4:** Cover for the second operating level
- Item 5:** Boiler water thermostat (DHW thermostat)

5.2 BC10 (EMS) base controller

The BC10 base controller allows the user to operate the basic controls of boilers with EMS/UBA 3 or EMS/SAFe.



USER NOTE

You can set additional functions via the MEC2.

Both dials must be in the "Aut" (automatic) position (otherwise an error message is displayed).

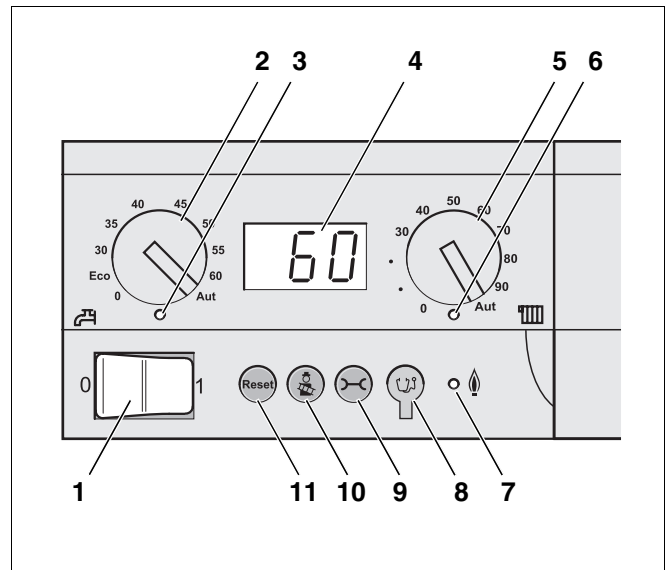

Fig. 14 Control layout on the BC10

- Item 1:** ON/OFF switch
- Item 2:** Dial for setting DHW temperature
- Item 3:** "DHW Hot Water" LED
- Item 4:** Status display
- Item 5:** Dial for maximum boiler temperature when in heating mode
- Item 6:** "CH Heating" LED
- Item 7:** "Burner" (ON/OFF) LED
- Item 8:** Diagnostic plug
- Item 9:** "Status display" button
- Item 10:** "Flue gas test" button
- Item 11:** "Reset" button

Restricting output

The boiler output can be restricted to 11 kW (or 50 kW with higher boiler outputs) using a jumper on the rear of the base controller.

- Remove base controller.
- If necessary, remove jumper (Fig. 15, **Item 1**) if you want to restrict boiler output.

Jumper	Condition	Explanations
	Not inserted	Output restricted to 11 kW (50 kW) (only for boilers with UBA3)
	Inserted	Output unrestricted (factory setting)

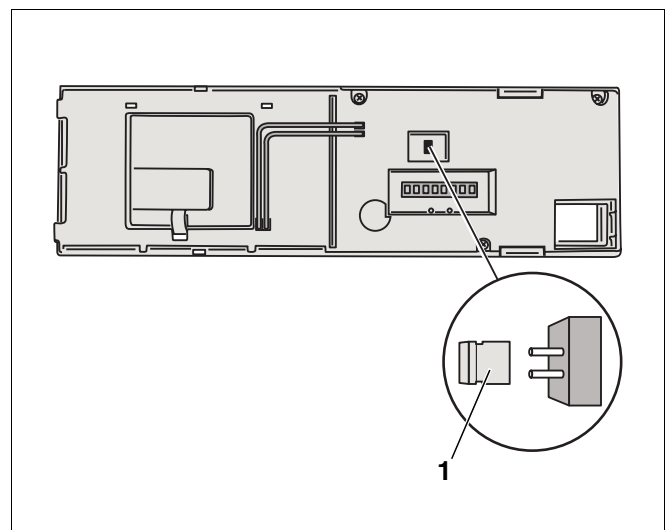

Fig. 15 Rear view of BC10 base controller

- Item 1:** Jumper for restricting output

6 MEC 2 programmer

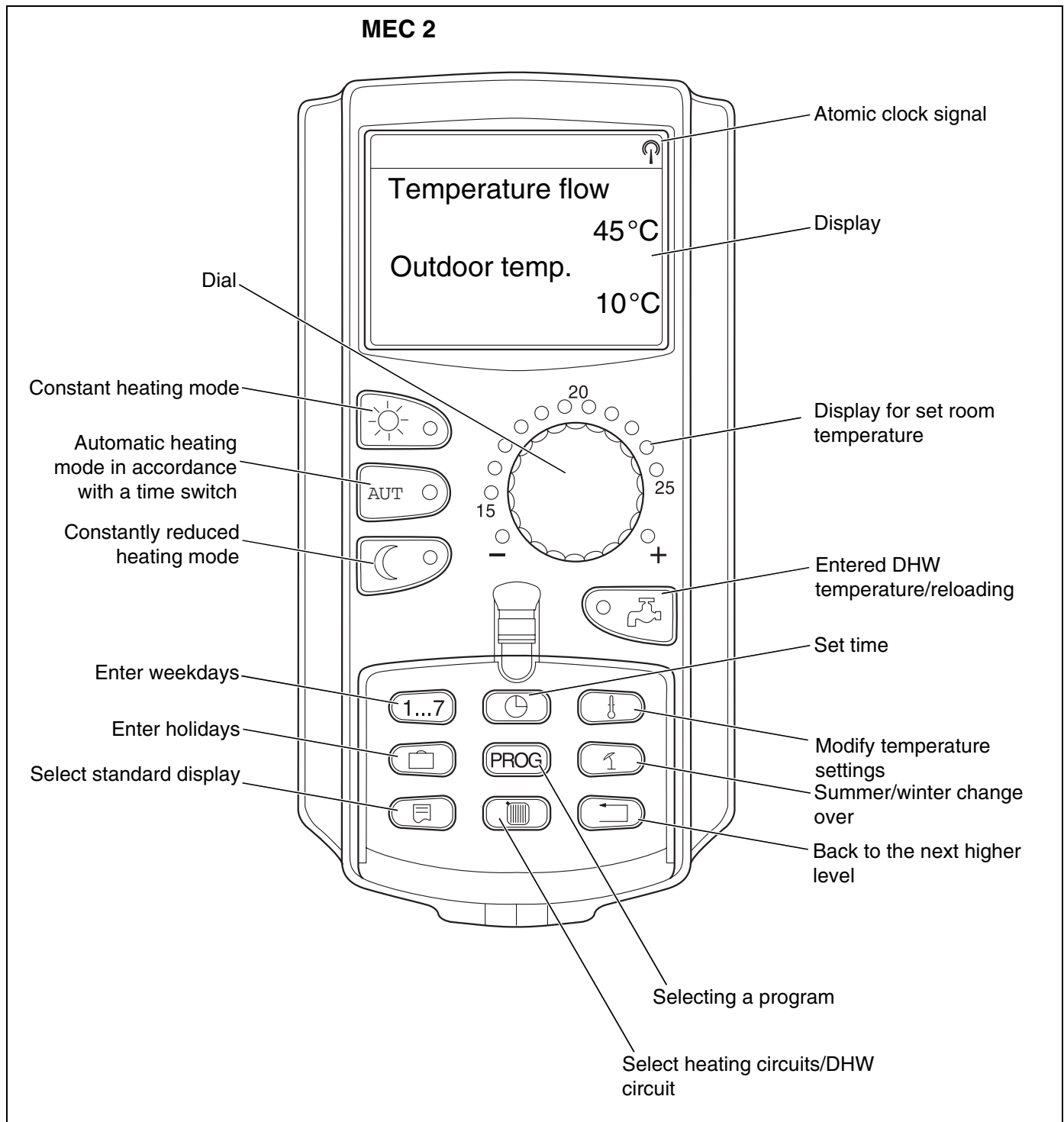

Fig. 16 MEC 2



USER NOTE

The MEC2 and RC30 must not be operated simultaneously.

- Use only MEC2 for heating systems with Logamatic 4000.

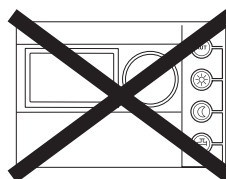

7 Commissioning the MEC 2 Programmer

You can use the MEC 2 for all Logamatic 4000 control units.



USER NOTE

If the control unit is equipped with a boiler display, use the MEC 2 as master control unit for setting up the other control units.

The MEC 2 can:

- be fitted directly into the control unit or
- be wall-mounted as a remote control unit or
- be connected to a separate power supply unit via an adapter.

The MEC 2 commences the start up after a supply voltage is connected.

The display shows "MEC is initialised".

Then information is briefly displayed showing the control unit address.

If the MEC 2 is fitted inside the control unit or a wall-mounting frame, it will automatically recognise with which control unit it is connected (automatic identification). You do not have to select the control.

The information on display varies according to each individual application:

Brand new MEC 2 installed in the control unit

If a brand new MEC 2 has been installed in the control unit and the connections with the control unit have been established, data is immediately downloaded from the control unit. The display shows "Monitor data is taken from ctrl panel".

MEC is
initialised

Connection with
ctrl panel
address XX
established

Monitor data
is
taken
from ctrl panel

The MEC 2 was installed in another control unit

If the MEC 2 software is of a version, the display will show "Unknown ctrl panel".

- Remove the MEC 2 from the control unit and exchange for an MEC 2 of a suitable software version.

Unknown
ctrl panel

7.1 A MEC 2 with set parameters is installed in the control unit

After the MEC 2 has been installed in the control unit, the two adjacent displays will initially be redisplayed.

MEC is
initialised

Connection with
ctrl panel
address XX
established

a) Alternative control unit type

Initially, only data from the control unit can be downloaded, if the type of control unit varies from that entered into the MEC 2. The display will then show the adjacent details.

- Press button .

Other
ctrl panel type
Night button
receive

The display will then show the adjacent details.

Data is
taken
from ctrl panel

**b) Another control unit of the same type
(e.g. Logamatic 4122 with boiler display ZM 435)**

The display shows the adjacent details for approx. 3 seconds, if the MEC 2 is connected to another control unit of the same type.

If the MEC 2 is separated from the control unit and data is also modified, the display shows "Aut button transmit, night button receive", when the unit is reinstalled into a control unit of the same type. The control unit enquires, whether the new data should be accepted or whether the old data in the control unit should be used again.

- Press  = "Data is sent to ctrl panel".

The display will then show the adjacent details.

- Press  = "Data is taken from ctrl panel".

The display will then show the adjacent details.

NB
other
control panel

Aut button
transmit
Night button
receive

Data is
sent
to ctrl. panel

Data is
taken
from ctrl. panel

c) Identical control unit

If the MEC 2 is separated from the control unit and data is also modified, the display shows "Aut button transmit, night button receive", when the unit is reinstalled into the same control unit. The control unit enquires, whether the new data should be accepted or whether the old data in the control unit should be used again.

- Press  = "Data is sent to ctrl panel".

The display will then show the adjacent details.

- Press button  = "Data is taken from ctrl panel".

The display will then show the adjacent details.

Aut button
transmit
Night button
receive

Data is
sent
to ctrl. panel



Data is
taken
from ctrl panel

8 Calling up and modifying settings

8.1 Calling up the service level



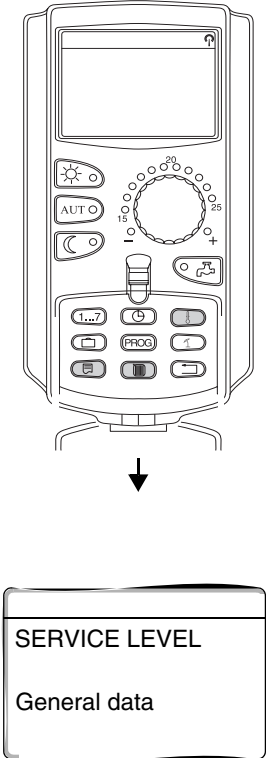

Access to the service level is password protected. The service level must only be used by the installer.

Unauthorised access to the service level invalidates your guarantee!

Step	Display	Comments/Notes
<p>Entering the password</p>  <p>Press these buttons simultaneously and then release them.</p>		 <p>USER NOTE The controls marked in grey are used for this function.</p> <p>This has activated the service level!</p>

Controls – press and turn

The service level covers several menu levels. There are further sub-menus connected with the selected menu item, if the last line is left blank (without setting entry).



<p>Calling up menu items</p>  Turn the dial.	<ul style="list-style-type: none"> - General data - Module selection - ... - Reset - General data 	<p>Scroll through menu levels.</p> <p>The menu items are structured as a loop and re-commence after the last menu item.</p>
<p>Call up sub-menu.</p>  Press once and release.  Turn the dial.  Press and hold down the button.  Press once and release.	<p>Example: General data</p> <ul style="list-style-type: none"> - Min. outside temperature - ... - automatic maintenance message - General data 	<p>You reach all sub-menus by turning the control dial.</p> <p>Modification of parameter settings. Select function/temperature.</p> <p>Back to the next higher level.</p>





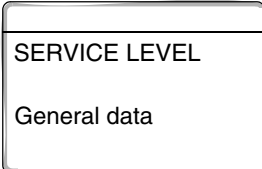

USER NOTE

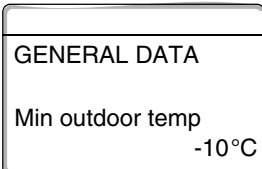
The menus displayed on the control unit depend on which modules are fitted and on their respective settings.

If menu entries contradict each other, the respective masks are, as far as possible, hidden.

Step	Display	Comments/Notes
<p>Call up the service level.</p>		<p>See "Calling up the service level" page 29.</p> <p>The first menu item displayed is "General Data".</p>
 Press button to call up menu item.		<p>The first menu item is "Minimum outdoor temp".</p> <p>The display shows the setting for individual menu items.</p>

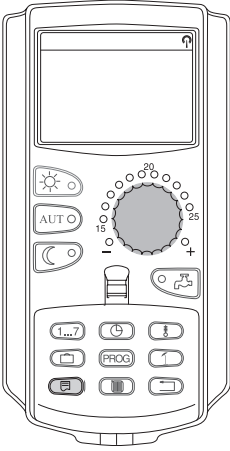
9 General data







Remedy	Display	Comments/Notes
<p>Call up the service level.</p> <p>Call up General Data.</p> <p> Press and then release the button.</p> <p> Turn the dial. The adjacent settings are displayed in sequence!</p>	<p>Display</p> <div data-bbox="647 389 911 562" style="border: 1px solid black; padding: 5px; margin-bottom: 20px;"> <p>SERVICE LEVEL</p> <p>General data</p> </div> <div data-bbox="667 600 898 1048" style="text-align: center;">  </div> <div data-bbox="647 1077 911 1249" style="border: 1px solid black; padding: 5px; margin-bottom: 20px;"> <p>GENERAL DATA</p> <p>Min outdoor temp -10°C</p> </div> <ul style="list-style-type: none"> - Minimum outdoor temp - Type of building - Summer/Winter clock ac. - Remote adjust. - Heat consumption - Manual control fault message - Automatic maintenance message 	<p>See "Calling up the service level" page 29.</p> <p>The first menu item displayed is "General Data".</p> <p> USER NOTE</p> <p>The controls marked in grey are used for this function.</p> <p>Under the heading "General Data", these settings may be set relating to the heating system and to the building characteristics.</p>

The following pages list the sub-menus of the General Data.

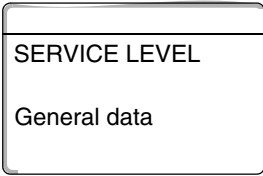
9.1 Minimum outside temperature

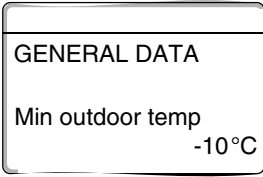
The minimum outside temperature is a statistical mean setting and influences the flow temperature.

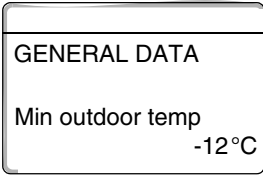
- Determine the minimum outside temperature for your region (average setting).

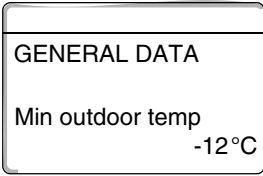
Remedy	Display	Comments/Notes
Call up the service level.		See "Calling up the service level" page 29.
 Press and release the button.		The first menu item displayed is "General Data".
 Press and hold down the button.		The first sub-menu item is "Minimum outdoor temp".
 Turn the dial to the required setting (here: -12 °C).		The setting (here: -10 °C) flashes.
 Release the dial to store the setting.		
 Press once and release.		Back to the next higher level.









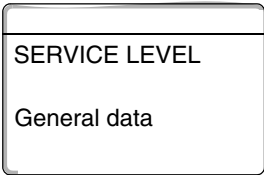

	Input range	Factory setting	Own input
Minimum outside temperature	-30 °C to 0 °C	-10 °C	

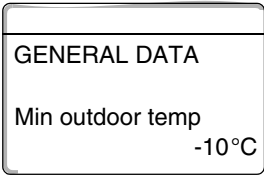
9.2 Type of construction

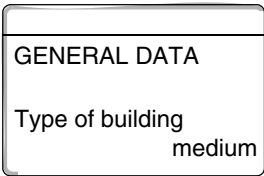
The heat storage capacity of the building can be entered under "Building type". Different types of buildings store heat for different lengths of time. This function can be used to match the heating system to the specified construction type.

- "LIGHT" – low heat storage capacity, e. g. pre-fabricated houses, wooden-framed constructions.
- "MEDIUM" – medium heat storage capacity, e. g. house built with breeze blocks, or poorly insulated brick built house.
- "HEAVY" – high heat storage capacity, e. g. well insulated house built with bricks.

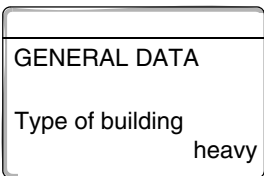
Enter the building type.

Remedy	Display	Comments/Notes
Call up the service level.		See "Calling up the service level" page 29.
 Press and release the button.		The first menu item displayed is "General Data".
 Turn the dial until "Type of building" appears.		
 Press and hold down the button.		The setting (here: medium) flashes.
 Turn the dial to the required type of building (here: heavy).		
 Release the dial to store the setting.		
 Press once and release.		Back to the next higher level.

	Input range	Factory setting	Own input
Type of building	Light Medium Heavy	Medium	

9.3 Switching the radio clock ON and OFF



USER NOTE

The MEC 2 contains a radio clock receiver, which constantly monitors and corrects the time switch inside the control unit. You need never set the time during commissioning; after prolonged power failure, after the heating system has been switched off for longer periods by its mains electrical isolator or for changing from summer to winter time and vice versa. (User NOTE this facility has no function in GB.)

Well screened boiler rooms in cellars can restrict the reception of the radio clock signal, which makes it necessary for you to set the date and time manually.

When using the MEC 2 as remote control, the reception of the radio clock signal depends on each location and position.

Reception of the radio clock signal is indicated by the symbol  on the display.

Normally the reception is only possible within a radius of 940 miles around Frankfurt/Main.









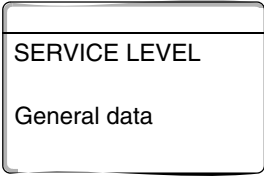

In case of reception problems, please observe the following:

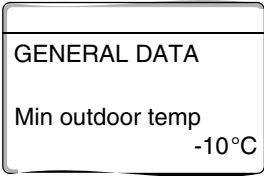
- The radio reception is weaker in rooms surrounded by steel-reinforced walls, in cellars, high-rise buildings, etc.
- Maintain a minimum distance of 1.5 m from sources of interference, such as computer monitors and TV sets.
- The radio reception tends to be better at night than during the day.

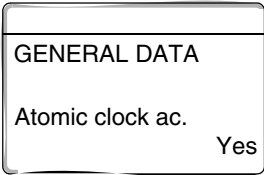

IMPORTANT NOTE

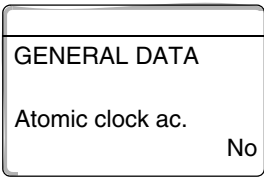
This feature does not function in the UK and Eire and should be switched off.

Remedy	Display	Comments/Notes
Call up the service level.		See "Calling up the service level" page 29. The first menu item displayed is "General Data".
 Press and release the button.		
 Turn the dial until "Atomic clock ac." appears.		
 Press and hold down the button.		The setting (here: Yes) flashes.
 Turn the dial to "Yes" or "No".		
 Release the dial to store the setting.		
 Press and release.		Back to the next higher level.

**USER NOTE**









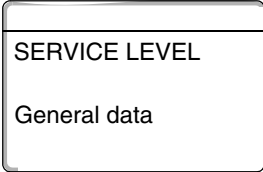

If you select "No", the reception of the radio clock signal will be turned OFF for all control units networked on the ECOCAN BUS. This also applies to radio clock signals from the BFU/F remote control.

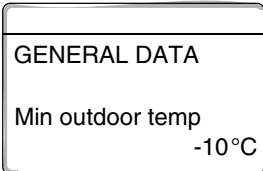
	Input range	Factory setting	Own input
Atomic clock ac.	Yes/No	Yes	

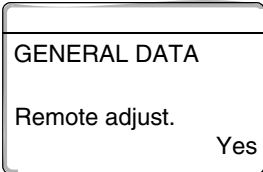
9.4 Remote adjustment

The remote adjustment offers the accessory of external data entry and adjustment via a remote system, e.g. the Logamatic remote system.

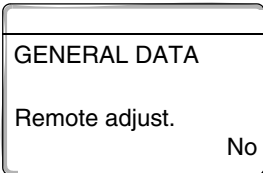







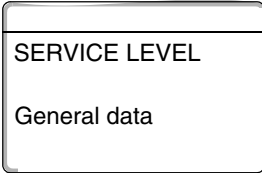

Yes = optional remote adjustment via the Logamatic telecontrol system,
 No = remote adjust. not possible.
 However, system data can be selected and monitored.

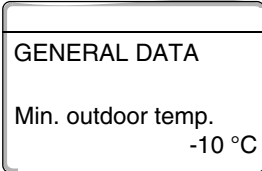
Remedy	Display	Comments/Notes
Call up the service level.		See "Calling up the service level" page 29.
 Press and release the button.		The first menu item displayed is "General Data".
 Turn the dial until "Remote adjust." appears.		
 Press and hold down the button.		The setting (here: Yes) flashes.
 Turn the dial to "Yes" or "No".		
 Release the dial to store the setting.		
 Press once and release.		Back to the next higher level.

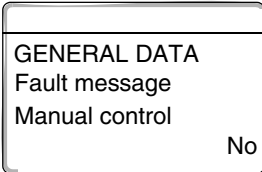
	Input range	Factory setting	Own input
Remote adjust.	Yes/No	Yes	

9.5 Manual control fault message

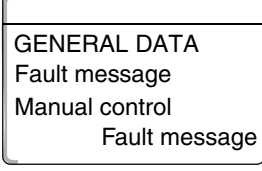
You can show a fault message on the display of the MEC2 when the function module manual control is on  or when the dial on the BC10 is not on "Aut".

Step	Display	Comments/Notes
Call up the service level.		See "Call up the service level" on page 29
 Press and release the button.		The first menu item displayed is "General Data".
 Turn the dial until "Manual control fault message" appears.		
 Press and hold down the button.		The setting (here: No) flashes.
 Turn the dial to the desired setting.		
 Release the dial to store the setting.		
 Press once and release.		Back to the next higher level.



USER NOTE

In the case of "No", a warning notice appears in MEC2 if the cover is closed.

If "Fault", an entry also appears in the error log. Automatic forwarding via the Logamatic telecontrol system is then possible.

In the case of "Central fault message", the output of a central fault message also appears via a volt-free contact e.g. via the FM448 or FM456/457 function module.

	Input range	Factory setting	Own input
Manual control fault message	No Fault message Central fault message	No	

9.6 Automatic maintenance message

You can generate an automatic maintenance message at the operator level on the MEC2 display.









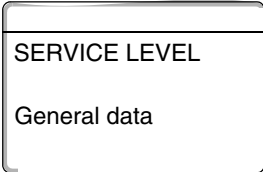

Here you can choose between:

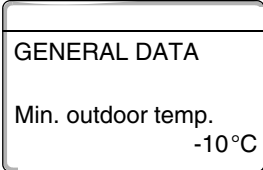
- Maintenance message according to hours run. Enter the number of operating hours after which you want the maintenance message to appear (100 – 6000 h).
- Maintenance message according to date. Enter the next maintenance date.
- Buderus recommend Service interval is 12 months.

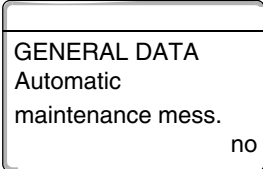

USER NOTE

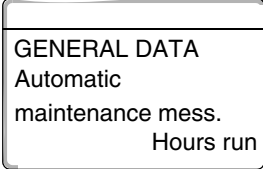
The maintenance message "after hours run" is only applicable when number of boilers = 1.

Step	Display	Comments/notes
Call up the service level.		See "Call up the service level" on page 29.
 Press and release the button.		The first menu item displayed is "General Data".
 Turn the dial until "Automatic maintenance message" appears.		The setting (here: No) flashes.
 Press and hold down the button.		
 Turn the dial to the desired setting.		
 Release the dial to store the setting.		
 Turn the dial one click clockwise.		



Press and hold down the button.



Turn to change the setting (date or operating hours).



Release the dial to store the setting.



Press and release.

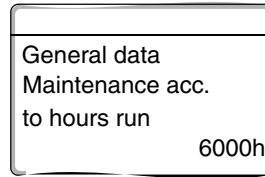

The setting (here: 6000 h) flashes.

Back to the next higher level.



USER NOTE

The maintenance message is recorded in the error log and can be transferred via the Logamatic telecontrol system.

The status of the maintenance message can be scanned in the "Monitor" menu.

The maintenance message can be reset using the "Reset" menu.



USER NOTE











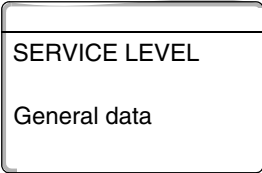

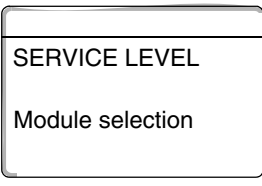
In systems with more than one boiler (cascade systems), we recommend a maintenance message according to "date".

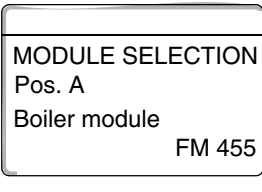
	Input range	Factory setting	Own input
Automatic maintenance message	No Hours run Date	No	

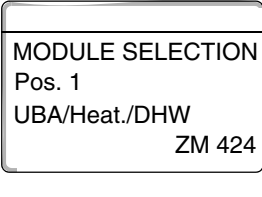
10 Module selection

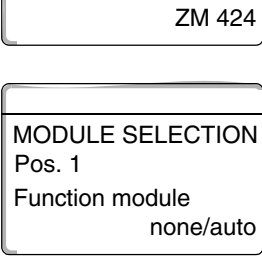
The modules are automatically recognised and their information downloaded on starting the Logamatic 41xx control unit or after resetting the unit.

However, these modules can also be set manually.







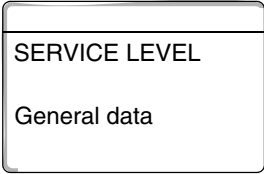

Remedy	Display	Comments/Notes
<p>Call up the service level.</p>		<p>See "Calling up the service level" page 29.</p> <p>The first menu item displayed is "General Data".</p>
<p> Turn the dial until "Module selection" appears.</p>		
<p> Press and release the button.</p>		<p>The display shows that boiler module FM 455 is installed in slot A.</p>
<p> Turn the dial until the next slot is displayed.</p>		<p>The setting (here: ZM 424) flashes.</p>
<p> Press and hold down the button.</p>		<p> USER NOTE We recommend the setting "none/auto". These modules are automatically recognised and installed.</p>
<p> Turn the dial to the required function module.</p>		
<p> Release the dial to store the setting.</p>		
<p> Press once and release.</p>		<p>Back to the next higher level.</p>

11 Boiler data

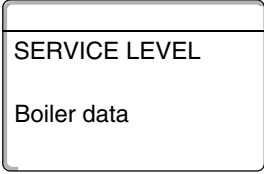
You can, if the control unit contains a cascade module, e.g. KSE module FM 456 or FM 457, setup the boiler data with this menu.

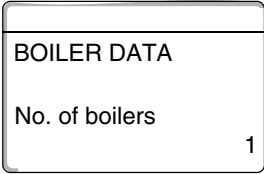
11.1 Set the number of boilers

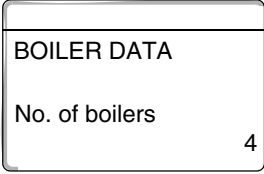







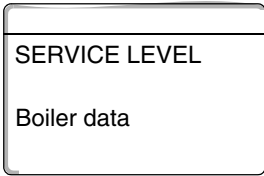

This function allows you to set the number or boilers in line with the module selection.

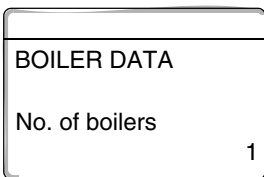
Remedy	Display	Comments/Notes
Call up the service level.		See "Calling up the service level" page 29.
 Turn the dial until "Boiler data" appears.		The first menu item displayed is "General Data".
 Press and release the button.		The setting (here: 1) flashes.
 Turn the dial until the required setting is shown.		Here you set the number of boilers to be run. You may set the maximum number of boilers = 8, e.g. if two FM457 multi-boiler modules are used in one Logamatic 4122 control panel.
 Release the dial to store the setting.		If you set the number of boilers = 0, the control unit will operate as control 1 heating circuit.
 Press once and release.		Back to the next higher level.

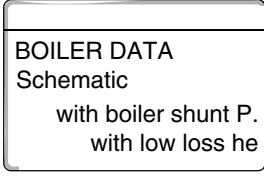
	Input range	Factory setting	Own input
Number of boilers (depending on module selection)	0 – 8	1	

11.2 Select Hydraulic design for single boiler

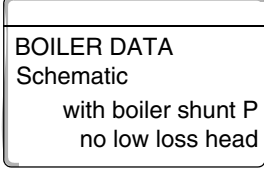
You may use this function, if the **no. of boilers 1**. You may choose, whether the boiler hydraulics operate with or without a boiler shunt P or low loss header.





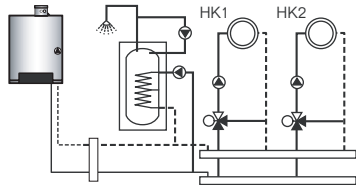
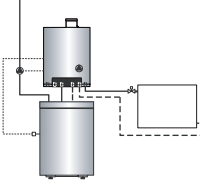
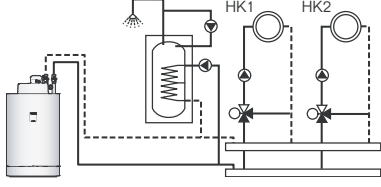



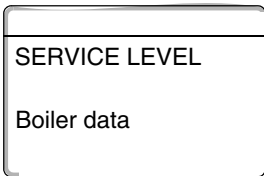

Remedy	Display	Comments/Notes
<p>Call up the service level.</p>		<p>See "Calling up the service level" page 29.</p>
<p> Turn the dial until "Boiler data" appears.</p>		
<p> Press and release the button.</p>		<p>The display shows the first menu point "No. of boilers". At least one boiler must be displayed.</p>
<p> Turn the dial until "Schematic" appears.</p>		
<p> Press and hold down the button.</p>		<p>The setting (here: with boiler circ. P/with low loss he) flashes.</p>
<p> Turn the dial until the required setting is shown.</p>		
<p> Release the dial to store the setting.</p>		
<p> Press once and release.</p>		<p>Back to the next higher level.</p>

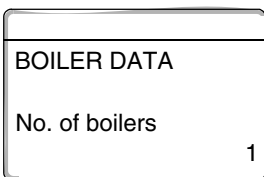
11 Boiler data

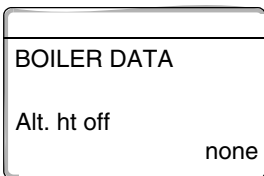
	Input range		Factory setting	Own input
Hydraulic design options	with boiler shunt P/ low loss header		with boiler shunt P/ low loss header	
	with boiler shunt P/ without low loss header			
	without boiler shunt P/ without low loss header			

11.3 Select hydraulic design for cascade systems

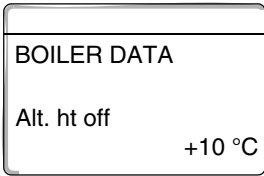
This function allows you to set the temperature, using modulating EMS boilers.

Remedy	Display	Comments/Notes
Call up the service level.		See "Calling up the service level" page 29.
 Turn the dial until "Boiler data" appears.		
 Press and release the button.		The display shows the first menu point "No. of boilers". Must be greater than 1.
 Turn the dial until "Detection alt. ht off". heat sources from appears.		
 Press and hold down the button.		The setting (here: none) flashes.
 Turn the dial until the required setting is shown.		
 Release the dial to store the setting.		
 Press once and release.		Back to the next higher level.







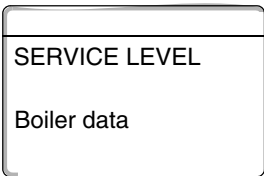

Example:

At a setting of 10°C the boiler(s) switch(es) off once the actual temperature is 10°C higher than the set flow temperature.

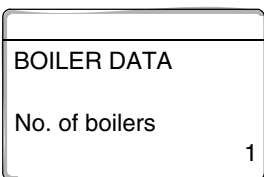
	Input range	Factory setting	Own input
Temperature for external heat source recognition	5 – 20 °C none	none	

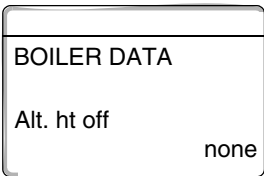
11.4 Setting to alt. heat sources

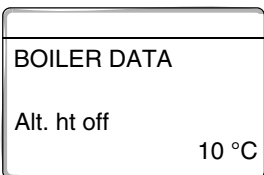
This function allows you to set the temperature, at which alt. heat sources are recognised.

Remedy	Display	Comments/Notes
Call up the service level.		See "Calling up the service level" page 29.
 Turn the dial until "Boiler data" appears.		
 Press and release the button.		The display shows the first menu point "No. of boilers".
 Turn the dial until "Detection alt. ht off". heat sources from appears.		
 Press and hold down the button.		The settings (here: none) flashes.
 Turn the dial until the required setting is shown.		
 Release the dial to store the setting.		
 Press once and release.		Back to the next higher level.







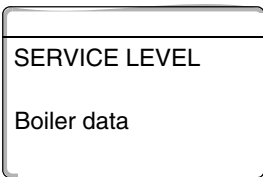

Example:

At a setting of 10°C the boiler(s) switch(es) off once the actual temperature is 10°C higher than the set flow temperature.

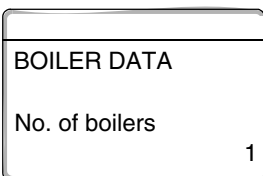
	Input range	Factory setting	Own input
Temperature for external heat source recognition	5 – 20 °C none	none	

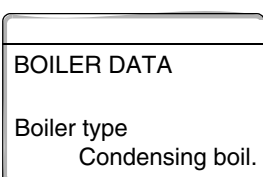
11.5 Select the boiler type

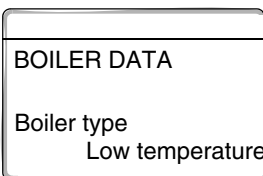
This function allows you to select from the various types of boilers.

Remedy	Display	Comments/Notes
<p>Call up the service level.</p>		<p>See "Calling up the service level" page 29.</p>
<p> Turn the dial until "Boiler data" appears.</p>		
<p> Press and release the button.</p>		<p>The display shows the first menu point "No. of boilers".</p>
<p> Turn the dial until "Boiler type" appears.</p>		
<p> Press and hold down the button.</p>		<p>The setting (here: Condensing boil) flashes.</p>
<p> Turn the dial until the required type of boiler is shown.</p>		<p> USER NOTE In a cascade system, the "Low temperature" setting must be selected, provided that a non-condensing boiler has been installed.</p>



USER NOTE

For boilers with integral three-way valves, electrically isolate this valve if DHW is not directly heated by the boiler.

Back to the next higher level.



Release the dial to store the setting.











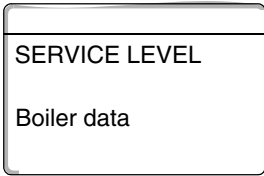

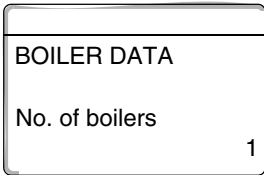
Press once and release.

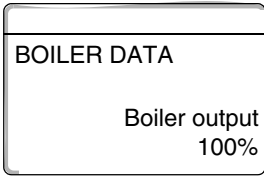
	Input range	Factory setting	Own input
Boiler type	Condensing Low-temperature	Condensing	

11.6 Limit boiler output

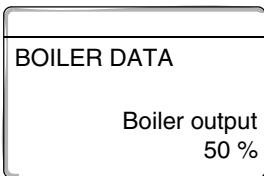







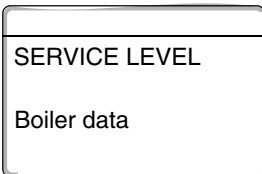

You may use this function, if the **number of boilers 1**.
 You can enter the maximum boiler output as percentage of its rated output.

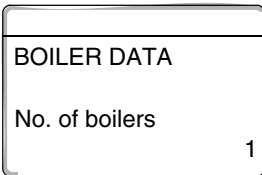
Remedy	Display	Comments/Notes
Call up the service level.		See "Calling up the service level" page 29.
 Turn the dial until "Boiler data" appears.		
 Press and release the button.		The display shows the first menu point "No. of boilers". At least one boiler must be displayed.
 Turn the dial until "Boiler output" appears.		
 Press and hold down the button.		The setting (here: 100 %) flashes.
 Turn the dial until the required setting is shown.		
 Release the dial to store the setting.		
 Press once and release.		Back to the next higher level.

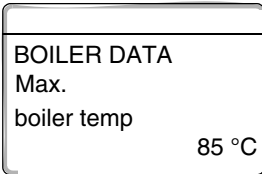
	Input range	Factory setting	Own input
Boiler output	50 – 100 %	100 %	

11.7 Setting the maximum boiler temperature

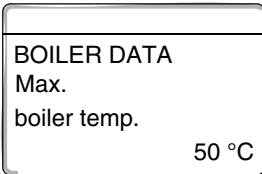





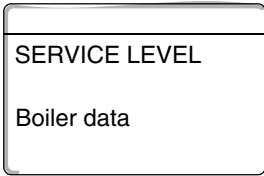

This function allows you to select the maximum set boiler temperature.

Remedy	Display	Comments/Notes
Call up the service level.		See "Calling up the service level" page 29.
 Turn the dial until "Boiler data" appears.		
 Press and release the button.		The display shows the first menu point "No. of boilers".
 Turn the dial until "Maximum boiler temp" appears.		
 Press and hold down the button.		The setting (here: 85 °C) flashes.
 Turn the dial until the required temperature is shown.		
 Release the dial to store the setting.		
 Press once and release.		Back to the next higher level.

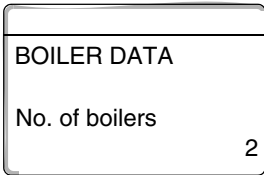
	Input range	Factory setting	Own input
Boiler temperature	50 – 90 °C	85 °C	

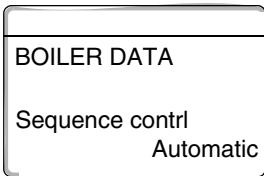
11.8 Selecting the type of sequence control

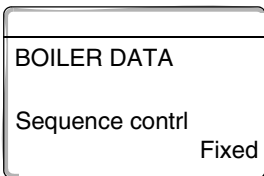
You may use this function, if the **number of boilers is at least 2**. This function allows you to set the type of Sequence control.

Remedy	Display	Comments/Notes
Call up the service level.		See "Calling up the service level" page 29.
 Turn the dial until "Boiler data" appears.		
 Press and release the button.		The display shows the first menu point "No. of boilers".
 Turn the dial until "Sequence contrl" appears.		
 Press and hold down the button.		The setting (here: Automatic) flashes.
 Turn the dial until the required setting is shown.		
 Release the dial to store the settings.		
 Press once and release.		Back to the next higher level.

The next page shows a summary of sequence control options.

	Input range	Factory setting	Own input
Sequence contrl	Automatic Fixed	Automatic	

Sequence contrl

If you select "Fixed", the boilers are controlled in the following order:

1 — 2 — 3 — 4

First, boiler no. 1 is switched ON, then boiler 2, etc.

If you select "automatic", the first boiler is selected according to date.

At the 1st of every month: 1 — 2 — 3 — 4

At the 2nd of every month: 2 — 3 — 4 — 1

At the 3rd of every month: 3 — 4 — 1 — 2

At the 4th of every month: 4 — 1 — 2 — 3

At the 5th of every month: 1 — 2 — 3 — 4

etc.



USER NOTE

If you have selected one of these settings: "UBA flow", "EMS flow", "UBA cylinder" or "EMS three-way valve", boiler 1 always appears last in the sequence:

At the 1st of every month: 2 — 3 — 4 — 1

At the 2nd of every month: 3 — 4 — 2 — 1

At the 3rd of every month: 4 — 2 — 3 — 1

At the 4th of every month: 2 — 3 — 4 — 1

etc.

12 Heating circuit data







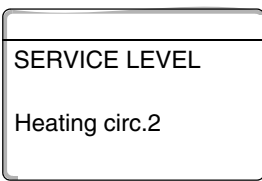

12.1 Select the heating system

You may select the following heating systems:

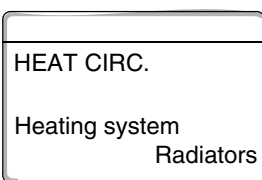
- None
The heating circuit function is not required. All subsequent submenu points relating to "Heat circ. data" no longer apply.
- Radiators or convector heater
The heating curve is automatically calculated for radiators or convector heaters, depending on the required curve.
- Under floor heating
A flatter heating curve is automatically calculated for lower design temperatures.
- Base point
The level of the flow temperature is a linear consequence of the outside temperature. The resulting heating curve connects as a straight line the Base point with a second point, which depends on the design temperature.
- Constant
Use this system for controlling a swimming pool heating system or to pre-control air conditioning. If the heating must always provide the same, set flow temperature, independent of the outside temperature. You cannot install a remote control for this heating circuit if you have selected this system.
- Room controller
The set level of the flow temperature is only dependent on the actual room temperature. For this purpose, you must install a remote control inside the room.
The heating system is switched OFF, if the room becomes too hot.

Example:

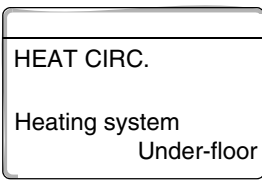







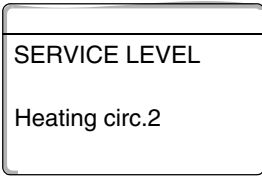

Select the heating system "Under-floor" for heating circuit 2:

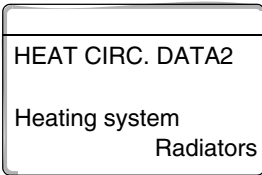
Step	Display	Comments/Notes
<p>Call up the service level.</p>  Turn the dial until "Heating circuit + heating circ. no." appears (here: Heat circ 2).		See "Calling up the service level" page 29.
 Press and release the button.		The display shows the first menu point "Heating system" for the selected heating circuit.
 Press and hold down the button.		The setting (here: Radiator) flashes.
 Turn the dial to the required heating system (here: Under-floor).		
 Release the dial to store the setting.		
 Press once and release.		Back to the next higher level.

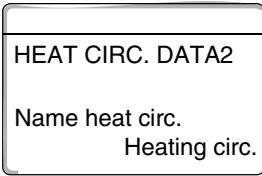
	Input range	Factory setting	Own input
Heating system	None Radiator Convector heater Under Floor Constant Base point Room controller	Radiator	

12.2 Rename the heating circuit

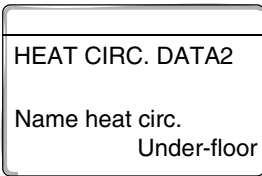
You may, instead of the description "Heating circ + Heating circ. no", select a different description from the default list.

Step	Display	Comments/Notes
Call up the service level.		See "Calling up the service level" page 29.
 Turn the dial until "Heating circ.+ heating circ. no." appears (here: Heat circ. 2).		
 Press and release the button.		The display shows the first menu point "Heating system" for the selected heating circuit.
 Turn the dial until the submenu "Name heat circ" appears.		
 Press and hold down the button.		The setting (here: Heating circ.) flashes.
 Turn the dial until the required description is displayed (here: Under-floor).		
 Release the dial to store the setting.		
 Press once and release.		Back to the next higher level.











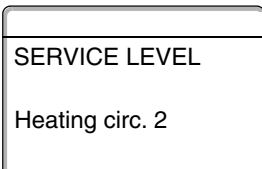

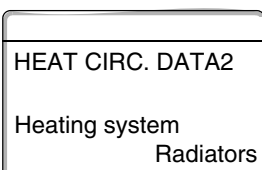

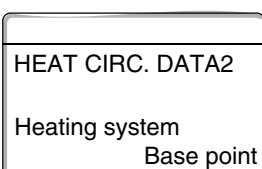
	Input range	Factory setting	Own input
Name heat circ.	Heating circ. Apartment Under Floor Bath Swimming pool Floors Cellar Building	Heating circ.	

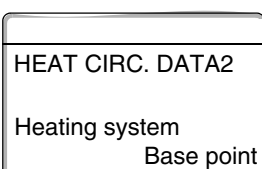
12.3 Set the Base point temperature

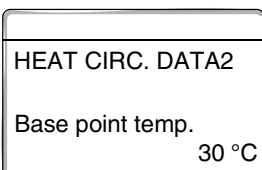
By setting the "Base point heating system" you have determined a straight heating line using the base point and the design temperatures.

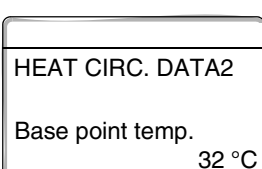
The base point temperature is applicable for an outside temperature of 20 °C.

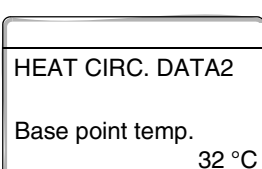







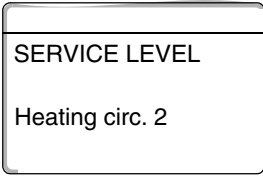

With the base point temperature, you determine the start of the heating line.

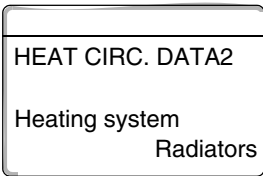
Step	Display	Comments/Notes
Call up the service level.		See "Calling up the service level" page 29.
 Turn the dial until "Heating circ.+ heating circ. no." appears (here: Heat circ. 2).		
 Press and release the button.		The display shows the first menu point "Heating system" for the selected heating circuit.
 Press and hold down		The setting (here: Radiators) flashes.
 Turn the dial until "Base point" appears.		
 Release the dial to store the setting.		
 Turn the dial until the submenu "Base point temp." appears.		
 Press and hold down the button.		The setting (here: 30 °C) flashes.
 Turn the dial until the required setting (here: 32 °C) appears.		
 Release the dial to store the setting.		
 Press once and release.		Back to the next higher level.

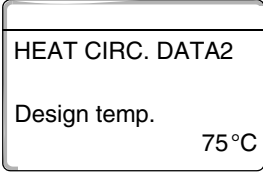
	Input range	Factory setting	Own input
Base point temperature	20 – 80 °C	30 °C	

12.4 Set the design temperature

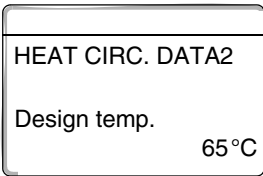
Set the design temperature at least 10° C higher than the base point temperature. Changing the design temperature allows the system to operate with a flatter or steeper heating line.

Step	Display	Comments/Notes
Call up the service level.		See "Calling up the service level" page 29.
 Turn the dial until "Heating circ.+ heating circ. no." appears (here: Heat circ. 2).		
 Press and release the button.		The display shows the first menu point "Heating system" for the selected heating circuit.
 Turn the dial until "Design temp." appears.		
 Press and hold down the button.		The setting (here: 75 ° C) flashes.
 Turn the dial and set the design setting relative to the minimum outside temperature.		
 Release the dial to store the setting.		
 Press once and release.		Back to the next higher level.







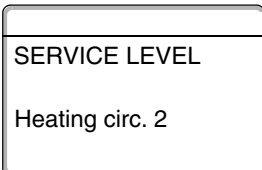

	Input range	Factory setting	Own input
Design temperature	30 – 90 °C	75 °C for radiators 45 °C for under-floor heating	

12.5 Minimum flow temperature

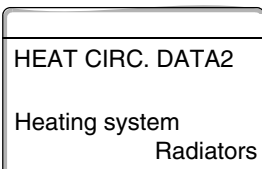
The minimum flow temperature limits the heating curve to a minimum setting.

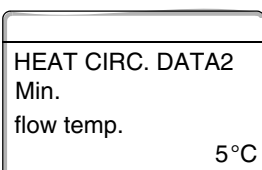
This function is not displayed for "Constant" heating systems.

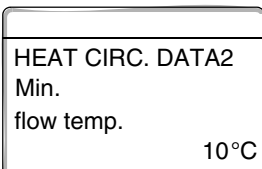
Change this setting if necessary.

Step	Display	Comments/Notes
Call up the service level.		See "Calling up the service level" page 29.
 Turn the dial until "Heating circ.+ heating circ. no." appears (here: Heat circ.2).		
 Press and release the button.		The display shows the first menu point "Heating system" for the selected heating circuit.
 Turn the dial until the submenu "Min. flow temp." appears.		
 Press and hold down the button.		The setting (here: 5 °C) flashes.
 Turn dial and set design temperature.		This setting sets the temperature, below which the flow temperature must not drop.
 Release the dial to store the setting.		
 Press once and release.		Back to the next higher level.







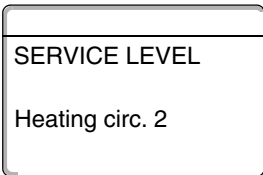

	Input range	Factory setting	Own input
Minimum flow temperature	5 – 70 °C	5 °C	

12.6 Maximum flow temperature

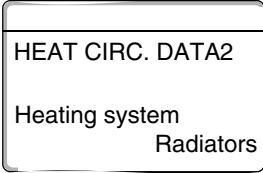
The maximum flow temperature limits the heating curve to a maximum setting.

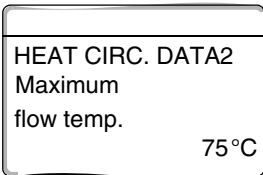
This function is not displayed for "Constant" heating systems.

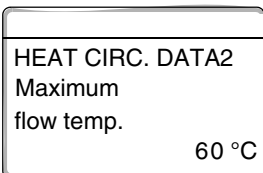
Change this setting if necessary.

Step	Display	Comments/Notes
Call up the service level.		See "Calling up the service level" page 29.
 Turn the dial until "Heating circ. + heating circ. no." appears (here: Heat circ. 2).		
 Press and release the button.		The display shows the first menu point "Heating system" for the selected heating circuit.
 Turn the dial until the submenu "Max flow temp." appears.		
 Press and hold down the button.		The setting (here: 75 °C) flashes.
 Turn dial and set design temperature.		The set design temperature determines the setting, above which the flow temperature must not rise.
 Release the dial to store the setting.		
 Press once and release.		Back to the next higher level.

	Input range	Factory setting	Own input
Maximum flow temperature for underfloor	30 – 60 °C	50 °C	
Maximum flow temperature for radiators, convector heaters, base point	30 – 90 °C	75 °C	

12.7 Select the remote control

Under this menu item, you can determine whether a remote control will be installed for the heating circuit concerned. Here you can select the following:

- No remote control
- Remote control with display (MEC 2)
"MEC heat. circ."
- Remote control without display (BFU or BFU/F;
BFU/F currently not available in UK).



USER NOTE

Remote control units cannot be installed with "Constant" heating systems or where systems are "Ext. changeover" (as with modules FM 441 and 442).

Modules ZM 424, FM 456 and FM 457 cannot be subjected to external changeover.

Remote control units cannot be installed for the heating circuits of modules FM 456 and FM 457.

A remote control must be installed, to enable the following functions which monitor the room temperature:

- Night setback with room stop
- Max room influence
- Automatic adjustment
- Optimisation
- Heating system "Room controller"

Explanations relating to "MEC heat. circ."







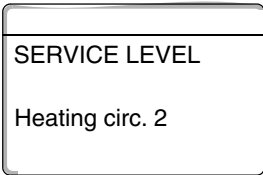

With the MEC 2 you can operate several heating circuits simultaneously. These are grouped together under the term "MEC heat. circ."

The following functions can be carried out for "MEC heat. circ.":

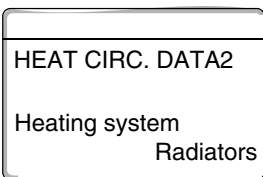
- Changing the operating mode
- Adjusting the setting
- Changeover between summer and winter
- Holiday function
- Party function
- Pause function

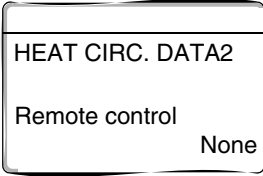
The heating circuits grouped together under "MEC heat. circ." can, for specific settings, also be selected as "Single heat circ".

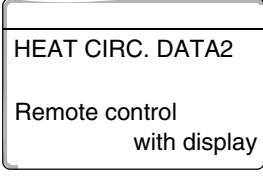
The timer program "PROG" function is only available for each individual heating circuit.

Step	Display	Comments/Notes
<p>Call up the service level.</p> <p> Turn the dial until "Heating circ. + heating circ. no." appears (here: Heat circ. 2).</p>		<p>See "Calling up the service level" page 29.</p>
<p> Press and release the button.</p>		<p>The display shows the first menu point "Heating system" for the selected heating circuit.</p>
<p> Turn the dial until "Remote control" appears.</p>		<p>This function is not available for heating circuits from modules FM 456 and 457.</p>
<p> Press and hold down the button.</p>		<p>The settings (here: None) flashes.</p>
<p> Turn the dial and set the required setting.</p>		<p>Turn the dial to "with display", when the selected heating circuit has been allocated to the MEC 2.</p>
<p> Release the dial to store the setting.</p>		
<p> Press once and release.</p>		<p>Back to the next higher level.</p>

	Input range	Factory setting	Own input
Remote control	None without display with display	None	

12.8 Maximum room influence









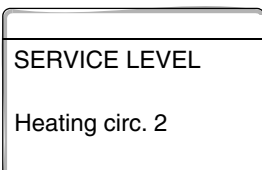

This function only appears, if remote control has been selected.

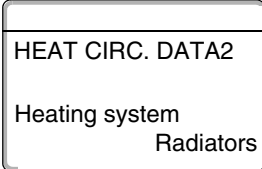
The "max room infl" limits the influence of the room temperature (room temperature connection) on the flow temperature setting. The setting determines the maximum room temperature reduction for those rooms, which are not equipped with remote controls.

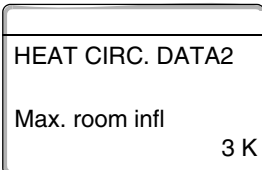

USER NOTE

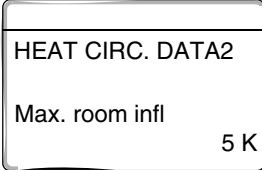
Do not expose the MEC 2 or the BFU remote control to alternative heat sources, such as lamps, TV sets, etc.

Step	Display	Comments/Notes
Call up the service level.		See "Calling up the service level" page 29.
 Turn the dial until "Heating circ.+ heating circ. no." appears (here: Heat circ. 2).		
 Press and release the button.		The display shows the first menu point "Heating system" for the selected heating circuit.
 Turn the dial until the submenu "Max. room infl" appears.		
 Press and hold down the button.		The setting (here: 3 K) flashes.
 Turn the dial and set the required setting.		You set the temperature range with the dial.
 Release the dial to store the setting.		
 Press once and release.		Back to the next higher level.

	Input range	Factory setting	Own input
Max room infl	0 – 10 K	3 K	

12.9 Select the Setback type

You can select the following functions for setback or night operation:

- The "Outdoor setback" determines the outside temperature limit.
The heating circuit is switched OFF when this setting is exceeded.
Below this setting the heating system heats up to the set night room temperature.
- With "Room setback" you determine a set night temperature as room temperature.
The heating circuit is switched OFF when this setting is exceeded.
Below this setting the heating system heats up to the set night room temperature.
For this function a remote control must be located in the relevant room.
- In setback mode, the heating circuit is generally switched OFF at the "OFF".
- In setback mode, the system heats up to the set night room temperature when "reduced" is selected. The heating circuit pumps operate constantly.











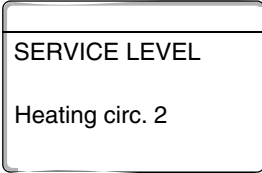

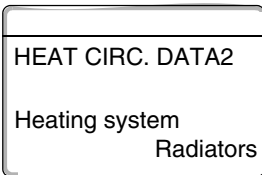
USER NOTE

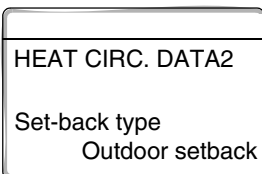
You can only select "Reduced", "Outdoor setback" or "OFF", if you have selected "Constant" under the main menu item "Heating system".

- Setting the heating system to "Room controller" and Setback type to "Reduced" achieves the same effect for temperature setback as "Room setback".

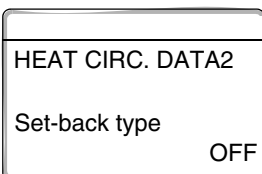







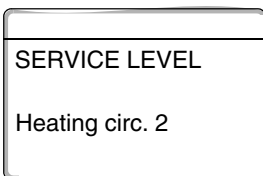

12 Heating circuit data

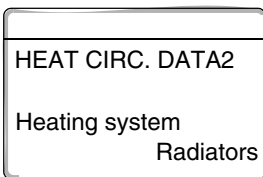
Step	Display	Comments/Notes
<p>Call up the service level.</p> <p> Turn the dial until "Heating circ.+ heating circ. no." appears (here: Heat circ. 2).</p>		See "Calling up the service level" page 29.
<p> Press and release the button.</p>		The display shows the first menu point "Heating system" for the selected heating circuit.
<p> Turn the dial until "Setback type" appears.</p>		
<p> Press and hold down the button.</p>		The setting (here: Outdoor setback) flashes.
<p> Turn the dial and set the required setting.</p>		You set the required type of setback with the dial.
<p> Release the dial to store the setting.</p>		
<p> Press once and release.</p>		Back to the next higher level.

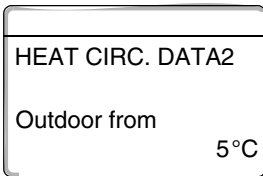
	Input range	Factory setting	Own input
Setback type	OFF Reduced Room setback Outdoor setback	Outdoor setback	

12.10 Set the Outdoor setback temperature

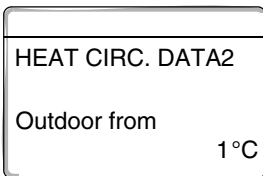







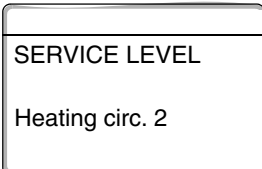

Enter the outside temperature at which the heating operation should change over from "OFF" to "Reduced", if you have selected "Outdoor setback" as setback type.

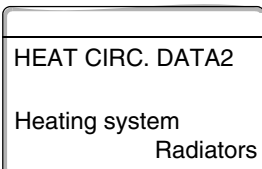
Step	Display	Comments/Notes
Call up the service level.		See "Calling up the service level" page 29.
 Turn the dial until "Heating circ. + heating circ. no." appears (here: Heat circ. 2).		
 Press and release the button.		The display shows the first menu point "Heating system" for the selected heating circuit.
 Turn the dial until "Outdoor from" appears.		
 Press and hold down the button.		The setting (here: 5 °C) flashes.
 Turn the dial and set the required setting.		You set the outside stop temperature with the dial.
 Release the dial to store the setting.		
 Press once and release.		Back to the next higher level.

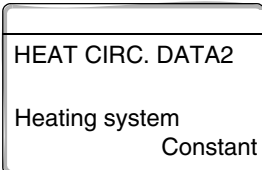
	Input range	Factory setting	Own input
Outdoor from	-20 °C to +10 °C	5 °C	

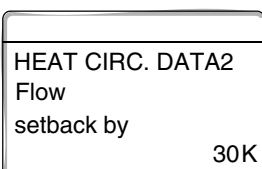
12.11 Setting system flow reduction

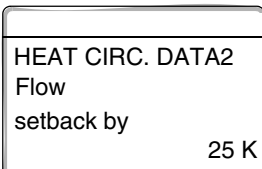
Since you cannot connect a **remote control** to heating systems set to "Constant", you may enter a setback setting for the "Reduced" and "Outdoor setback" types.

Step	Display	Comments/Notes
Call up the service level.		See "Calling up the service level" page 29.
 Turn the dial until "Heating circ. + heating circ. no." appears (here: Heat circ. 2).		
 Press and release the button.		The display shows the first menu point "Heating system" for the selected heating circuit.
 Press and hold down the button.		The setting (here: Radiators) flashes.
 Turn the dial until "Constant" appears.		
 Release the dial to store the setting.		
 Turn the dial until the submenu "Flow setback by" appears.		
 Press and hold down the button.		The setting (here: 30 K) flashes.
 Turn the dial and set the required setting.		You set the amount of flow temperature reduction with the dial.
 Release the dial to store the setting.		
 Press once and release.		Back to the next higher level.

	Input range	Factory setting	Own input
Flow setback	0 – 40 K	30 K	

12.12 Room temperature offset

This function is only practical where no programming unit has been installed in the apartment.









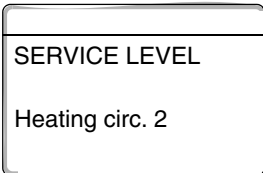

You can adjust settings with this function, if the actual temperature measured by the thermometer deviates from the setting.

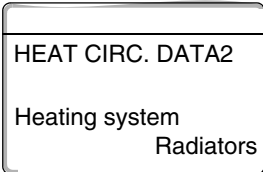
This adjustment moves the heating curve in parallel.

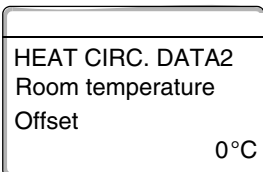
Example:

Displayed set room temperature	22 °C
Actual room temperature	24 °C

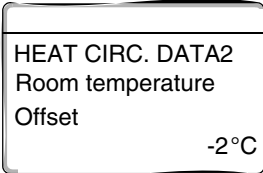
The setting lies 2 °C below the actual setting.

Step	Display	Comments/Notes
Call up the service level.		See "Calling up the service level" page 29.
 Turn the dial until "Heating circ. + heating circ. no." appears (here: Heat circ. 2).		
 Press and release the button.		The display shows the first menu point "Heating system" for the selected heating circuit.
 Turn the dial until the submenu "Room temperature offset" appears.		
 Press and hold down the button.		The setting (here: 0 °C) flashes.
 Turn the dial and set the required setting.		Correct the set room temperature by -2 °C.
 Release the dial to store the setting.		
 Press once and release.		Back to the next higher level.

	Input range	Factory setting	Own input
Offset	-5 °C to +5 °C	0 °C	

12.13 Automatic correction

The "Automatic correction" is not activated in the factory.









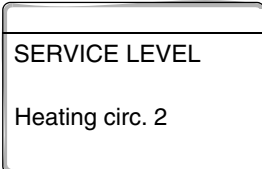

Prerequisites are:

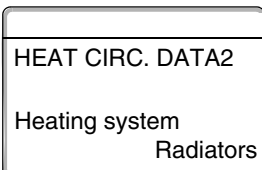
- a representative room with room sensor,
- completely open thermostatic valves in the room,
- no constantly variable alternative heat influence.

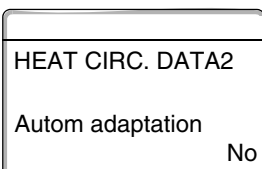

USER NOTE

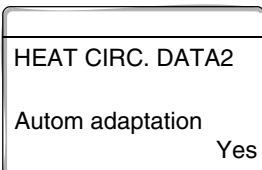
Where a remote control with room temperature sensor is installed in the room, the heating curve is automatically adjusted to the building by constantly monitoring the room and flow temperature.

Step	Display	Comments/Notes
Call up the service level.		See "Calling up the service level" page 29.
 Turn the dial until "Heating circ. + heating circ. no." appears (here: Heat circ. 2).		
 Press and release the button.		The display shows the first menu point "Heating system" for the selected heating circuit.
 Turn the dial until "Autom adaptation" appears.		
 Press and hold down the button.		The setting (here, No) flashes.
 Turn the dial and set the required setting.		Turn the dial to "Yes".
 Release the dial to store the setting.		
 Press once and release.		Back to the next higher level.

	Input range	Factory setting	Own input
Automatic correction	Yes/No	No	

12.14 Set switching optimisation

The function "Optimisation for" is not activated in the factory.











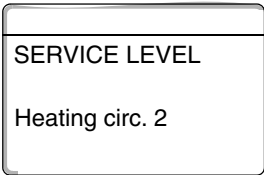

USER NOTE

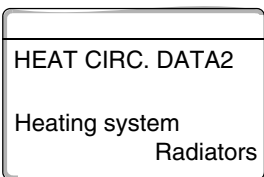
You must install a remote control unit with room temperature sensor to enable the "Optimisation" function.

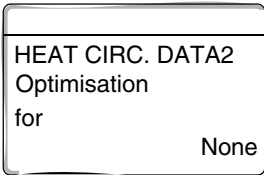
The following variations are available:

- With "Switch-ON", heating commences before the actual time designated by the timer.
The control calculates the start time, so that the set room temperature is achieved at the set switch-ON time.
- When "Switch OFF" has been enabled, the system begins the setback, where possible, prior to the actual setback time to save energy. If a room cools down unexpectedly or suddenly, the shutdown optimisation is terminated and heating continues normally up to the programmed setback time.

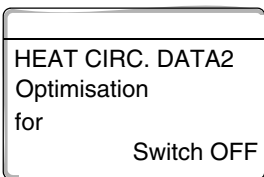







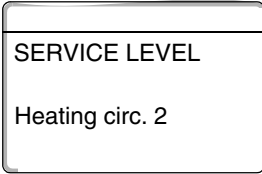

Both optimisation variants are used when "Switch-ON/Switch OFF" have been enabled. Switching optimisation is not implemented, if "None" is selected.

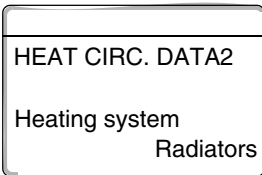
Step	Display	Comments/Notes
<p>Call up the service level.</p> <p> Turn the dial until "Heating circ. + heating circ. no." appears (here: Heat circ. 2).</p>		<p>See "Calling up the service level" page 29.</p>
<p> Press and release the button.</p>		<p>The display shows the first menu point "Heating system" for the selected heating circuit.</p>
<p> Turn the dial until the submenu "Optimisation for" appears.</p>		
<p> Press and hold down the button.</p>		<p>The setting (here: None) flashes.</p>
<p> Turn the dial and set the required setting.</p>		<p>Turn the dial until the required optimising variant appears (here: Switch OFF).</p>
<p> Release the dial to store the setting.</p>		
<p> Press once and release.</p>		<p>Back to the next higher level.</p>

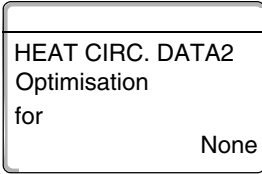
	Input range	Factory setting	Own input
Optimisation	None Switch-ON Switch OFF Switch-ON/Switch OFF	None	

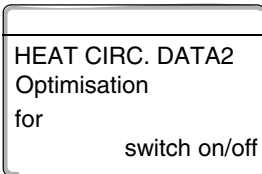
12.15 Set switch off optimisation time

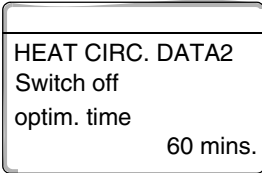
You may, if you have selected "Switch off" or "Switch ON/OFF" enter as of when the setback operation should begin. Change the setting only if necessary.

Step	Display	Comments/Notes
<p>Call up the service level.</p>		<p>See "Calling up the service level" page 29.</p>
<p> Turn the dial until "Heating circ. + heating circ. no." appears (here: Heat circ. 2).</p>		
<p> Press and release the button.</p>		<p>The display shows the first menu point "Heating system" for the selected heating circuit.</p>
<p> Turn the dial until the submenu "Optimisation for" appears.</p>		
<p> Press and hold down the button.</p>		<p>The setting (here: None) flashes.</p>
<p> Turn the dial and set the required setting.</p>		<p>Turn the dial until the required optimising variant appears: Switch OFF or Switch ON/OFF (here: Switch ON/OFF).</p>
<p> Release the dial to store the setting.</p>		
<p> Turn the dial until "Switch off optim. time" appears.</p>		
<p> Press and hold down the button.</p>		<p>The setting (here: 60 min) flashes.</p>

12 Heating circuit data



Turn the dial and set the required setting.



Release the dial to store the setting.



Press once and release.

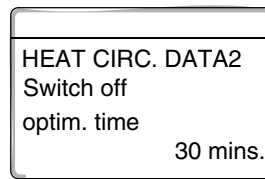

Select a time up to 60 minutes.









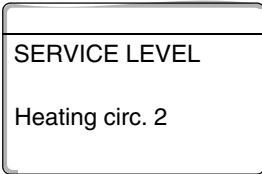

Back to the next higher level.

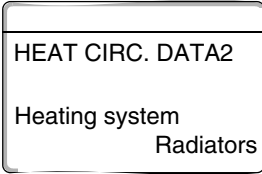
	Input range	Factory setting	Own input
Switch off optim. time	10 – 60 minutes	60 minutes	

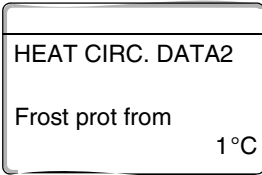
12.16 Set the frost protection temperature

Only change the frost protection setting in special circumstances.

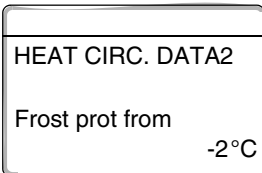
The circulation pump is automatically switched on, as soon as a set outside temperature threshold is reached.

Step	Display	Comments/Notes
<p>Call up the service level.</p>  Turn the dial until "Heating circ. + heating circ. no." appears (here: Heat circ. 2).		See "Calling up the service level" page 29.
 Press and release the button.		The display shows the first menu point "Heating system" for the selected heating circuit.
 Turn the dial until "Frost prot from" appears.		
 Press and hold down the button.		The setting (here: 1 °C) flashes.
 Turn the dial and set the required setting.		Change the frost protection temperature to -2 °C.
 Release the dial to store the setting.		
 Press once and release.		Back to the next higher level.

	Input range	Factory setting	Own input
Frost protection	-20 °C to +1 °C	+1 °C	

12.17 Set DHW priority

If you activate the function "DHW priority", the circulation pumps of all heating circuits are switched OFF whilst DHW is being heated.









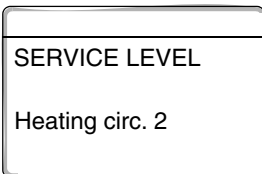

In mixed heating circuits, the valve is moved towards "Valve closes" (colder).

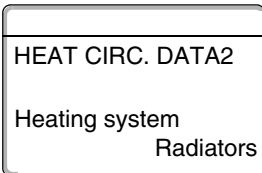
This affects all heating circuits which are networked on an ECOCAN bus.

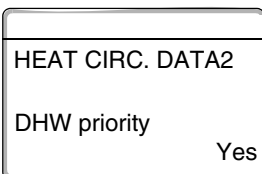

USER NOTE

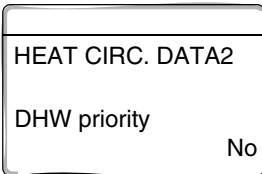
This function cannot be carried out if you have selected "UBA cylinder", "UBA flow", "EMS three-way valve" or "EMS flow" in the "DHW data" menu (page 85).

Step	Display	Comments/Notes
Call up the service level.		See "Calling up the service level" page 29.
 Turn the dial until "Heating circ. + heating circ. no." appears (here: Heat circ. 2).		
 Press and release the button.		The display shows the first menu point "Heating system" for the selected heating circuit.
 Turn the dial until "DHW priority" appears.		
 Press and hold down the button.		The setting (here: Yes) flashes.
 Turn the dial and set the required setting.		Turn the dial until "No" appears.
 Release the dial to store the setting.		
 Press once and release.		Back to the next higher level.

	Input range	Factory setting	Own input
DHW priority	Yes/No	Yes	

12.18 Input heating circuit mixing valve

You may determine via the "Valve" function, whether or not the system is equipped with a heating circuit valve.









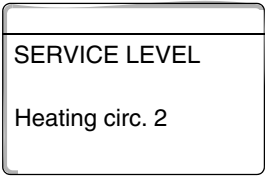

The control unit drives the valve, if it is installed into the heating circuit (mixer).

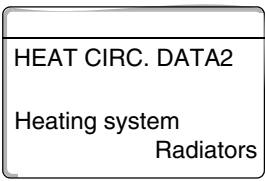
The heating circuit is controlled via the boiler flow temperature, if the system is not equipped with an valve.

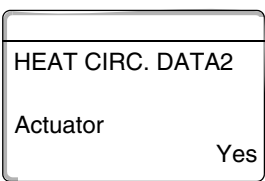

USER NOTE

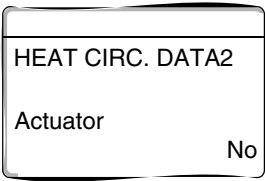
This function cannot be carried out if you have selected the setting "4000 cylinder" in the "DHW data" menu (page 85).

Step	Display	Comments/Notes
Call up the service level.		See "Calling up the service level" page 29.
 Turn the dial until "Heating circ.+ heating circ. no." appears (here: Heat circ. 2).		
 Press and release the button.		The display shows the first menu point "Heating system" for the selected heating circuit.
 Turn the dial until "Actuator" appears.		
 Press and hold down the button.		The setting (here: Yes) flashes.
 Turn the dial and set the required setting.		Turn the dial until "No" appears.
 Release the dial to store the setting.		
 Press once and release.		Back to the next higher level.

	Input range	Factory setting	Own input
Valve	Yes/No	Yes	









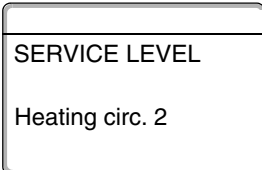

12.19 Enter valve running time

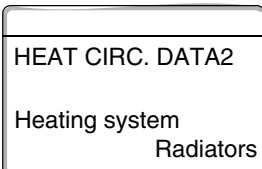
Here you may enter the valve running time of existing valves. Generally, actuators have a run time of 120 sec from fully open to fully closed.

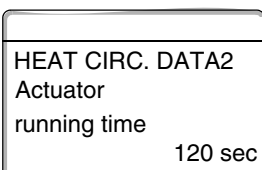

USER NOTE

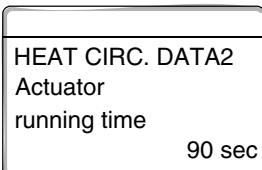
If you notice a constant oscillation of the valve, you can slow down the control characteristics by reducing the valve running time. Then the constant moving of the valve will cease.

Step	Display	Comments/Notes
Call up the service level.		See "Calling up the service level" page 29.
 Turn the dial until "Heating circ. + heating circ. no." appears (here: Heat circ. 2).		
 Press and release the button.		The display shows the first menu point "Heating system" for the selected heating circuit.
 Turn the dial until "Actuator running time" appears.		
 Press and hold down the button.		The setting (here: 120 s) flashes.
 Turn the dial and set the required setting.		Turn the dial until the required setting appears (here: 90 s).
 Release the dial to store the setting.		
 Press once and release.		Back to the next higher level.

	Input range	Factory setting	Own input
Valve running time	10 – 600 seconds	120 seconds	

12.20 Increasing boiler temperature

If a heating circuit is controlled with a valve, a higher design setting should be set for the boiler greater than the normal heating circuit setting.









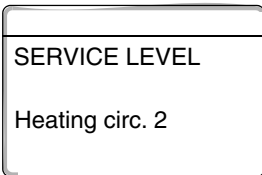

The setting "Increasing boil." corresponds to the temperature differential between the set boiler temperature and the set heating circuit temperature.

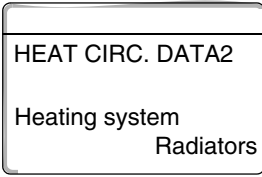

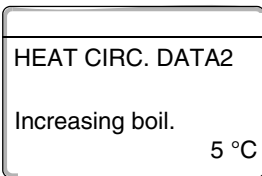
USER NOTE

Where possible set the setting to "0 °C" for modulating wall-mounted boilers; higher for all other boilers. This causes the valve to open permanently (hotter), whilst the burner controls the flow temperature.

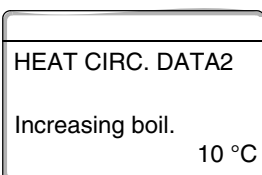
You must set the setting to "0 °C" is mandatory on wall-mounted boilers that do not have an internal boiler pump or low loss header.

Step	Display	Comments/Notes
Call up the service level.		See "Calling up the service level" page 29.
 Turn the dial until "Heating circ. + heating circ. no." appears (here: Heat circ. 2).		
 Press and release the button.		The display shows the first menu point "Heating system" for the selected heating circuit.
 Turn the dial until "Increasing boiler" appears.		
 Press and hold down the button.		The setting (here: 5 °C) flashes.
 Turn the dial and set the required setting.		Turn the dial until the required setting (here: 10 °C) appears.
 Release the dial to store the setting.		
 Press once and release.		Back to the next higher level.

	Input range	Factory setting	Own input
Increasing boil. temp	0 – 20 °C	5 °C	

12.21 Screed drying under floor heating

With this control unit you can enter a drying program for the screed, if the heating system includes underfloor heating.



USER NOTE

"Under-floor" must be set as heating system.

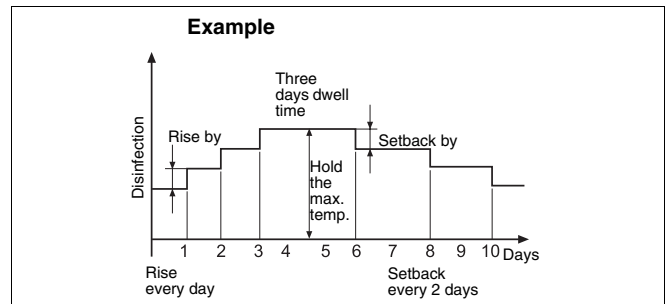

Fig. 17 Screed drying

Step	Display	Comments/Notes
Call up the service level.		See "Calling up the service level" page 29.
Turn the dial until "Heating circ. + heating circ. no." appears (here: Heat circ. 2).		
Press and release the button.		The display shows the first menu point "Heating system" for the selected heating circuit.
Turn the dial until "Cement drying" appears.		
Press and hold down the button.		The setting (here: No) flashes.
Turn the dial and set the required setting.		Turn the dial until "Yes" appears.
Release the dial to store the setting.		

The menu items on the following pages enable you to select the temperatures and settings for the drying time.

The setting reverts automatically to "No", as soon as the drying process has been completed.



USER NOTE





Screed drying only takes place on heating circuits with a valve.

	Input range	Factory setting	Own input
Screed drying	Yes/No	No	

Set temperature rise

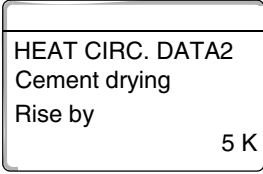
Here you can select, in what steps the temperature should increase to dry out the screed.

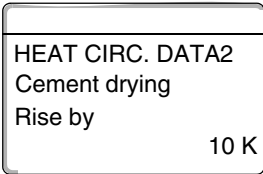



The temperature rise begins at 20 °C.

Step	Display	Comments/Notes
 Turn the dial until "Cement drying rise by" appears.		
 Press and hold down the button.		The setting (here: 5 K) flashes.
 Turn the dial and set the required setting.		Set the required setting (here: 10 K).
 Release the dial to store the setting.		

	Input range	Factory setting	Own input
Rise by	1 – 10 K	5 K	

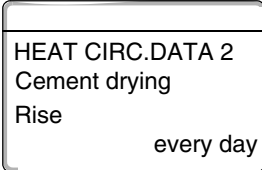
Heat-up time

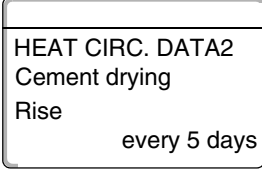



By setting the "Rise" parameter, you determine in which daily cycle the temperature should rise to dry out the screed.

Step	Display	Comments/Notes
 Turn the dial until "Cement drying + rise by" appears.		
 Press and hold down the button.		The setting (here: every day) flashes.
 Turn the dial and set the required setting.		Set the required setting, (here: every 5th day).
 Release the dial to store the setting.		

	Input range	Factory setting	Own input
Rise in daily cycles	1 – 5 days	Every day	

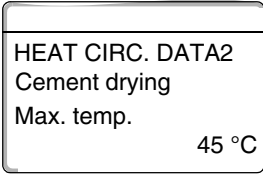
Set max. temp.

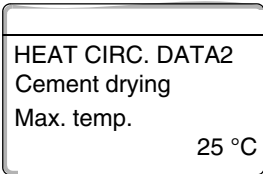



Here you may enter the maximum temp. for screed drying.

Step	Display	Comments/Notes
 Turn the dial until "Cement drying rise by" appears.		
 Press and hold down the button.		The setting (here: 45 °C) flashes.
 Turn the dial and set the required setting.		Set the required setting (here: 25 °C).
 Release the dial to store the setting.		

	Input range	Factory setting	Own input
Maximum temp.	25 – 60 °C	45 °C	

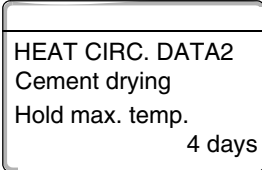
Set the holding time

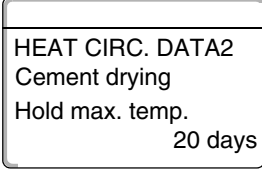
Here you can select a period of time, for which the maximum temperature shall be held to dry out the screed.





Step	Display	Comments/Notes
 Turn the dial until "Cement drying + hold max temp." appears.		
 Press and hold down the button.		The setting (here: 4 days) flashes.
 Turn the dial and set the required setting.		Set the required setting, (here: 20 days).
 Release the dial to store the setting.		

	Input range	Factory setting	Own input
Hold max. temp.	0 – 20 days	4 days	

Set setback temp.

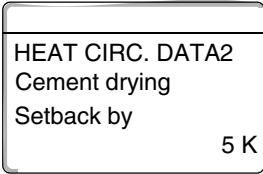
Here you can select, in what steps the temperature for drying out the screed should be setback.

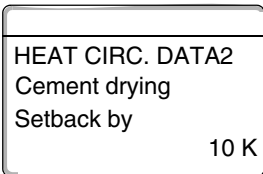



The setback ends at 20 °C.

Step	Display	Comments/Notes
 Turn the dial until "Cement drying + setback by" appears.		
 Press and hold down the button.		The setting (here: 5 K) flashes.
 Turn the dial and set the required setting.		Set the required setting (here: 10 K).
 Release the dial to store the setting.		

	Input range	Factory setting	Own input
Setback by	1 – 10 K	5 K	

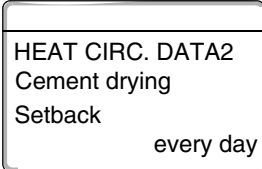
Set setback time

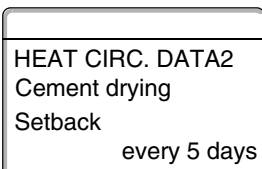
By setting the "Setback" parameter you determine, in which daily cycle the temperature for drying the screed should be setback.

Step	Display	Comments/Notes
 Turn the dial until "Cement drying + setback" appears.		
 Press and hold down the button.		The setting (here: every day) flashes.
 Turn the dial and set the required setting.		Set the required setting, (here: every 5th day).
 Release the dial to store the setting.		
 Press once and release.		Back to the next higher level.







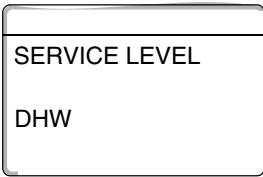

	Input range	Factory setting	Own input
Setback in daily cycles	None 1 – 5 days	Every day	

13 DHW data

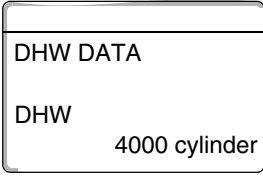
The "DHW" menu will only be displayed, if a module with DHW function is installed in the control unit.

13.1 Select DHW cylinder

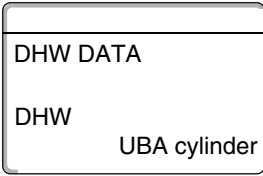
Here you can select the type of water connections - DHW cylinder.

Step	Display	Comments/Notes
<p>Call up the service level.</p>  <p>Turn the dial until "DHW" appears.</p>		<p>See "Calling up the service level" page 29.</p> <p>The first menu item "DHW" appears.</p>
 <p>Press and release the button.</p>		<p>The first menu item "4000 cylinder" appears.</p> <p>Select this setting when DHW sensor and DHW cylinder load pump are connected to the Logamatic 4000 control panel.</p>
 <p>Press and hold down the button.</p>		<p>The setting (here: 4000 cylinder) flashes.</p>
 <p>Turn the dial.</p>		<p>Select the required cylinder (here: UBA cylinder).</p>
 <p>Release the dial to store the setting.</p>		
 <p>Press once and release.</p>		<p>Back to the next higher level.</p>



USER NOTE

Depending on the boiler type, the settings are hidden when using UBA/EMS. The settings are checked internally for plausibility and adjusted if necessary.

	Input range	Factory setting	Own input
DHW cylinder	No 4000 cylinder UBA cylinder UBA flow EMS three-way valve EMS load pump EMS flow	4000 cylinder	

13.2 Set temperature range









With this function you can set the upper limit for the DHW design temperature.

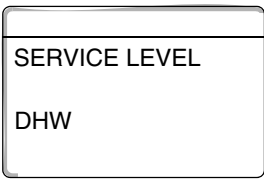

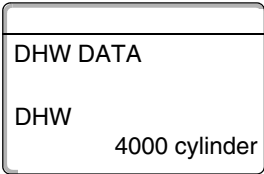
RISK OF SCALDING

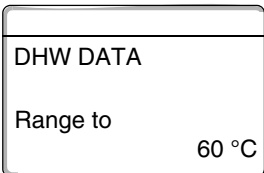
WARNING!

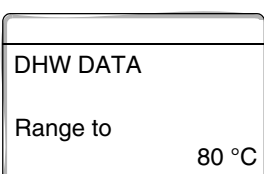
Setting the design temperature above 60 °C creates a danger of scalding from hot water.

Step	Display	Comments/Notes
Call up the service level.		See "Calling up the service level" page 29.
 Turn the dial until "DHW" appears.		The first menu item "DHW" appears.
 Press and release the button.		
 Turn the dial until "Range to" appears.		The setting (here: 60 °C) flashes.
 Press and hold down the button.		Set the required setting (here: 80 °C).
 Turn the dial to the required setting.		
 Release the dial to store the setting.		Back to the next higher level.
 Press once and release.		

	Input range	Factory setting	Own input
Range to	60 – 80 °C	60 °C	









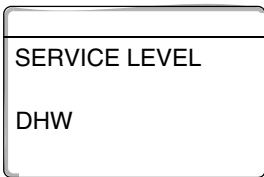

13.3 Select switching optimisation

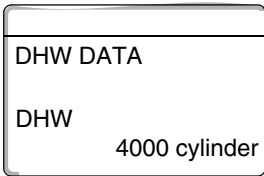
If you select the "Optimisation" function, the DHW will be heated prior to the actual switching point. The control unit calculates the timing of the start, taking into consideration the residual cylinder heat and the commencement of the heating for the heating circuits, so that the domestic hot water temperature is reached in good time.

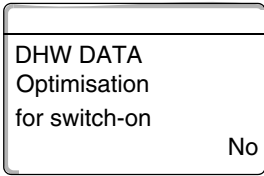

USER NOTE

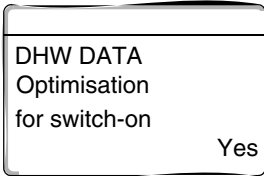
This function cannot be carried out if you have selected the "UBA flow" or "EMS flow" setting under the "DHW function" (see page 85).

Step	Display	Comments/Notes
Call up the service level.		See "Calling up the service level" page 29.
 Turn the dial until "DHW" appears.		
 Press and release the button.		The first menu item "DHW" appears.
 Turn the dial until "Optimisation for switch-ON" appears.		
 Press and hold down the button.		The setting (here: No) flashes.
 Turn the dial.		Set the required setting (here: Yes).
 Release the dial to store the setting.		
 Press once and release.		Back to the next higher level.

	Input range	Factory setting	Own input
Optimisation	Yes/No	No	

13.4 Heat over run to DHW cylinder

If you select the "Heat over run" function, you can utilise the residual boiler heat for DHW cylinder loading.









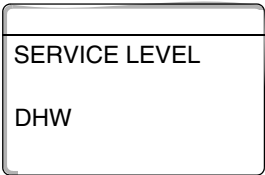

The "Heat over run" function is not available for cascade systems. It is inappropriate for wall-mounted boilers as the low water content means hardly any residual heat is available. In such cases we recommend that you turn the "Residual heat utilisation" OFF.

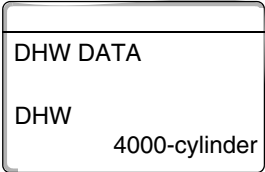
"Heat over run, yes"

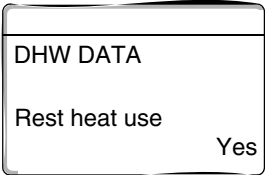
If you select "Heat over run, yes", the control calculates the shutdown temperature of the burner and the run-time of the load pump via the residual boiler heat, until the cylinder is fully loaded. The burner is switched OFF before the set domestic hot water temperature is reached. The cylinder load pump continues to operate. The control unit calculates the run-time of the load pump (between 3 and 30 minutes) to fully load the cylinder.

"Heat over run, no"

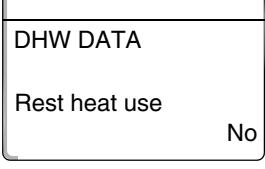
If you select "Heat over run, no", you will only utilise a small amount of residual heat. The burner runs until the set domestic hot water temperature is reached. The cylinder load pump runs on for 3 minutes after the burner is switched OFF.

Step	Display	Comments/Notes
<p>Call up the service level.</p>		<p>See "Calling up the service level" page 29.</p>
<p> Turn the dial until "DHW" appears.</p>		
<p> Press and release the button.</p>		<p>The first menu item "DHW" appears.</p>
<p> Turn the dial until "Rest heat use" appears.</p>		
<p> Press and hold down the button.</p>		<p>The setting (here: Yes) flashes.</p>
<p> Turn the dial.</p>		<p>Set the required setting (here: No).</p>
<p> Release the dial to store the setting.</p>		
<p> Press once and release.</p>		<p>Back to the next higher level.</p>

	Input range	Factory setting	Own input
Heat over run	Yes/No	Yes	









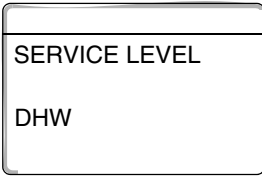

13.5 Set hysteresis

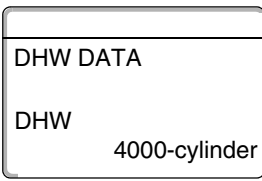
With the "Hysteresis" function you can determine, at how many Kelvin (K) below the set DHW temperature the reloading of the cylinder begins.

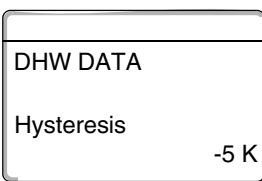

USER NOTE

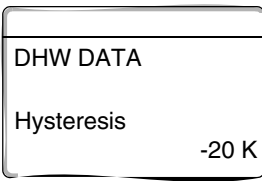
This function can only be carried out if you have selected the "4000 cylinder" setting under the "DHW" function (see page 85).

Step	Display	Comments/Notes
Call up the service level.		See "Calling up the service level" page 29.
 Turn the dial until "DHW" appears.		
 Press and release the button.		The first menu item "DHW" appears.
 Turn the dial until "Hysteresis" appears.		
 Press and hold down the button.		The setting (here: – 5 K) flashes.
 Turn the dial.		Set the required setting (here: – 20 K).
 Release the dial to store the setting.		
 Press once and release.		Back to the next higher level.

	Input range	Factory setting	Own input
Hysteresis	-20 to -2 K	-5 K	

Set switch-off hysteresis (not currently available in the UK)









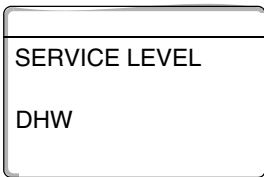

If you selected the LAP module FM 445, you can determine with the "Switch-OFF hysteresis" function, how close the temperature of the "Switch-OFF sensor" must be to the set DHW temperature to end loading.

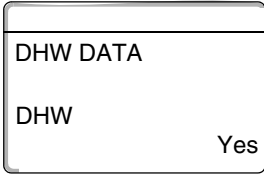

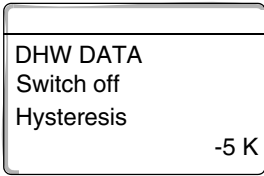
USER NOTE

Switch-OFF temperature = DHW setting – Switch-OFF hysteresis

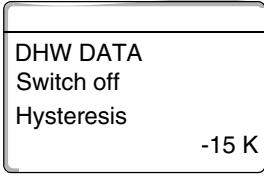
The switch-off sensor is generally located in the lower part of the cylinder.

Step	Display	Comments/Notes
<p>Call up the service level.</p>  Turn the dial until "DHW" appears.		See "Calling up the service level" page 29.
 Press and release the button.		The first menu item "DHW" appears.
 Turn the dial until "Switch-OFF hysteresis" appears.		
 Press and hold down the button.		The setting (here: –5 K) flashes.
 Turn the dial.		Set the required setting (here: –15 K).
 Release the dial to store the setting.		
 Press once and release.		Back to the next higher level.

	Input range	Factory setting	Own input
Hysteresis	–15 to –2 K	–5 K	

Set start-up hysteresis (currently not available in the UK)

If during module selection, you have selected the **LAP module FM 445**, you can determine with the "Switch-ON hysteresis" function, by what setting the temperature of the "Switch-ON sensor" can drop against the switch-OFF temperature (but not against the set DHW temperature), before reloading can begin.



USER NOTE

Switch-ON temperature =
Switch-off temperature – Switch-ON hysteresis

Step	Display	Comments/Notes
Call up the service level.		See "Calling up the service level" page 29.
Turn the dial until "DHW" appears.		
Press and release the button.		The first menu item "DHW" appears.
Turn the dial until "Switch-ON hysteresis" appears.		
Press and hold down the button.		The setting (here: –5 K) flashes.
Turn the dial.		Set the required setting (here: –15 K).
Release the dial to store the setting.		
Press once and release.		Back to the next higher level.

	Input range	Factory setting	Own input
Hysteresis	–15 to –2 K	–5 K	

13.6 Select the primary LAP circuit (currently not available in the UK)

If you selected the LAP module FM 445 during module selection, you can with the "LAP primary" function determine the type of primary circuit control.









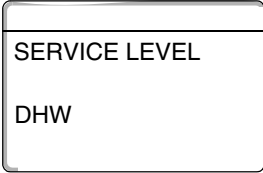

WARNING!

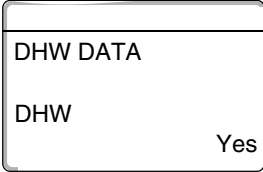
RISK OF SCALDING

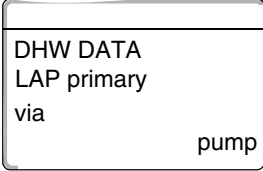
through overheating the system. Only use the settings "UBA" or "EMS" if:

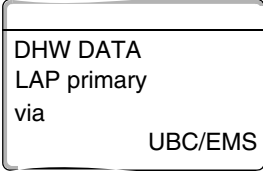
- the boiler used and the KIM number/BIM number are approved for this purpose (see page 85),
- the UBA 1.5 software is version 3.4 or higher.

Step	Display	Comments/Notes
<p>Call up the service level.</p>  Turn the dial until "DHW" appears.		See "Calling up the service level" page 29.
 Press and release the button.		The first menu item "DHW" appears.
 Turn the dial until "LAP primary" appears.		The selected primary circuit (here: pump) flashes.
 Press and hold down the button.		
 Turn the dial.		Set the required primary circuit (here: UBC/EMS).
 Release the dial to store the setting.		
 Press once and release.		Back to the next higher level.

	Input range	Factory setting	Own input
LAP primary	Pump Valve UBC/EMS (see list on the following page)	Pump	

Approved boiler types



USER NOTE

Use the "UBA/EMS" setting for the "LAP primary" function only on the following boiler types.

Please note the KIM or BIM number.









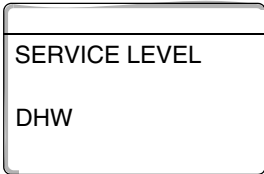

setting	type	KIM-Nr.	Boiler type
setting „UBA / EMS“	UBA1 / UBA 1.5	74	Logamax plus GB112 - 11/s
		76	Logamax plus GB112 - 19/s
		81	Excellent HR 22
		83	Excellent HR 30
		84	Excellent HR 45
		85	Excellent HR 65
		91	Logamax plus GB112 - 24
		93	Logamax plus GB112 - 29
		94	Logamax plus GB112 - 43
		95	Logamax plus GB112 - 60/W AT
		96	Logamax plus GB112 - 60/W NL
		97	Logamax plus GB112 - 60 BE
		100	Logamax U112 - 19
		102	Logamax U114 - 19
		107	Logamax U122 - 20
		108	Logamax U122 - 24
		131	Logamax plus GB112 - 24 BE
	133	Logamax plus GB112 - 29 BE	
	134	Logamax plus GB112 - 43 BE	
	EMS / UBA3	1000	Logamax plus GB142 - 30
		1002	Logamax plus GB142 - 24
		1003	Logamax plus GB142 - 15
		1015	Logamax plus GB142 - 45
		1016	Logamax plus GB142 - 60
		1025	Logamax plus GB132 - 16
		1026	Logamax plus GB162 - 100
		1027	Logamax plus GB162 - 80
		1032	Logamax plus GB132 - 24

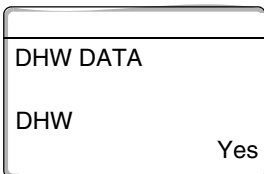
KIM numbers for boilers with UBA 1.x, EMS/UBA3 or EMS/SAFE

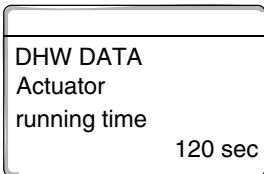
setting	type	BIM-Nr.	Boiler type			
setting „UBA / EMS“ not possible	EMS / SAFE	5001	Logano G135 - 18			
		5002	Logano G135 - 25			
		5003	Logano G125 - 17/21/28/34			
		5008	Logano G225 BE- 45			
		5009	Logano G225 BE- 55			
		5010	Logano G225 BE- 68			
		5011	Logano G225 BZ- 85			
		6001	Logano G144			
		6011	Logano G244 -38			
		6012	Logano G244 -44			
		6013	Logano G244 -50			
		6014	Logano G244 -55			
		6015	Logano G244 -60			
		6031	Logamax plus GB312 - 80			
		6032	Logamax plus GB312 - 120			
		setting „UBA / EMS“	EMS / SAFE	6033	Logamax plus GB312 - 160	
				6034	Logamax plus GB312 - 200	
6035	Logamax plus GB312 - 240					
6036	Logamax plus GB312 - 280					
6037	Logamax plus GB312 - 90					
6041	Logamax plus GB312 - 80 / NL					
6042	Logamax plus GB312 - 120 / NL					
6043	Logamax plus GB312 - 160 / NL					
6044	Logamax plus GB312 - 200 / NL					
6045	Logamax plus GB312 - 240 / NL					
6046	Logamax plus GB312 - 280 / NL					
6047	Logamax plus GB312 - 90 / NL					
setting „UBA / EMS“ not possible	type	KIM-Nr.	Combi Boiler			
				UBA1 / UBA 1,5	92	Logamax plus GB112 - 29/T25
				EMS / UBA3	111	Logamax U124 - 20K
					113	Logamax U124 - 24K
					1006	Logamax plus GB132T - 19
1007	Logamax plus GB132T - 11					
1033	Logamax plus GB132K - 24					

Set the valve run-time (currently not available in the UK)

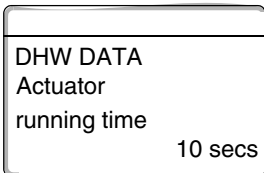
If you selected valve in the "LAP primary" menu, you can now set the valve run-time.

Step	Display	Comments/Notes
Call up the service level.		See "Calling up the service level" page 29.
 Turn the dial until "DHW" appears.		
 Press and release the button.		The first menu item "DHW" appears.
 Turn the dial until "Actuator running time" appears.		
 Press and hold down the button.		The setting (here: 120 s) flashes.
 Turn the dial.		Set the required setting (here: 10 s).
 Release the dial to store the setting.		
 Press once and release.		Back to the next higher level.

	Input range	Factory setting	Own input
Valve running time	10 – 600 s	120 s	

13.7 Increase boiler temperature

You will need the "Increase boiler" to determine the boiler water temperature during DHW heating.









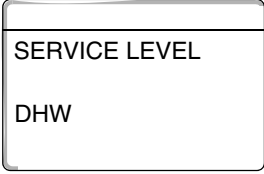

The "Increase boiler", is added to the set domestic hot water temperature and results in the set boiler flow setting for domestic hot water heating.

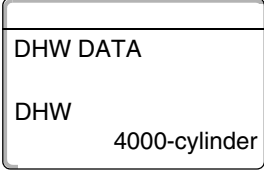
The factory setting of 40 K is best suited to rapid DHW loading.

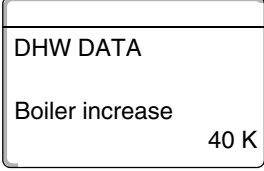

USER NOTE

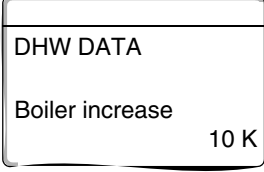
This function can only be carried out if you have selected the "4000 cylinder" setting under the "DHW" function (see page 85)









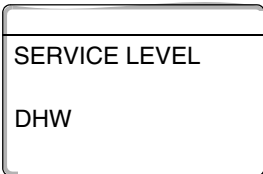

Step	Display	Comments/Notes
Call up the service level.		See "Calling up the service level" page 29.
 Turn the dial until "DHW" appears.		
 Press and release the button.		The first menu item "DHW" appears.
 Turn the dial until "Increase boiler" appears.		
 Press and hold down the button.		The setting (here: 40 K) flashes.
 Turn the dial.		Set the required setting (here: 10 K).
 Release the dial to store the setting.		
 Press once and release.		Back to the next higher level.

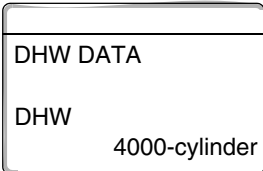
	Input range	Factory setting	Own input
Boiler increase	10 – 40 K	40 K	

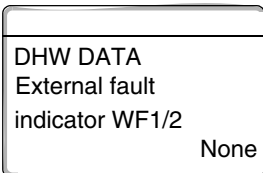
13.8 External fault indication (WF1/WF2)

Depending on the domestic hot water cylinder, you may connect an external, volt-free fault indicator contact from a load pump, a three-way valve or an inert anode to terminals WF1 and WF2 of modules ZM424, FM441 and FM445.

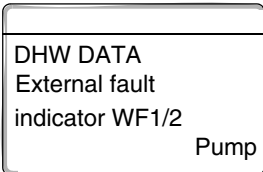
- Contacts WF1 and WF2 closed = no faults,
- contacts WF1 and WF2 open = faults.

Step	Display	Comments/Notes
Call up the service level.		See "Calling up the service level" page 29.
 Turn the dial until "DHW" appears.		
 Press and release the button.		The first menu item "DHW" appears.
 Turn the dial until "External fault WF1/2" is displayed.		
 Press and hold down the button.		The fault indicator (here: None) flashes.
 Turn the dial.		Set the required fault indication (here: Pump).
 Release the dial to store the setting.		
 Press once and release.		Back to the next higher level.

	Input range	Factory setting	Own input
Fault message (subject to boiler type and module)	None Inert anode Pump Three-way valve	None	

13.9 External contact (WF1/WF3)

If a volt-free pushbutton is connected to terminals WF1 and WF3 of module ZM 424, either "Single load" or "Disinfection" can be triggered (subject to selection).

The timer will then be switched off automatically.

"Single load"









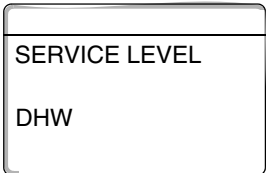

You may, if the DHW heating has been switched OFF according to the switching times of the DHW program, start "Single load" with the pushbutton (press once). The DHW circulation pump is switched ON simultaneously.

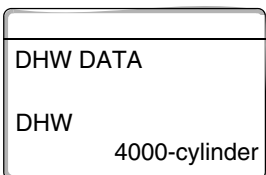
Contrary to single load via the MEC 2, the "Single load" process cannot be stopped via the MEC 2.

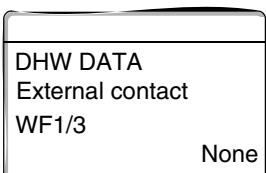
The "Single load" will only be stopped when the DHW cylinder has been fully loaded.

"Disinfection"

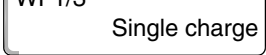
You can, if you have chosen "Disinfection" for the external contact, start the disinfection process with the above volt-free pushbutton. This disables any existing disinfection programs.

Step	Display	Comments/Notes
<p>Call up the service level.</p>		<p>See "Calling up the service level" page 29.</p>
<p> Turn the dial until "DHW" appears.</p>		
<p> Press and release the button.</p>		<p>The first menu item "DHW" appears.</p>
<p> Turn the dial until "External contact WF1/3" is displayed.</p>		
<p> Press and hold down the button.</p>		<p>The setting (here: None) flashes.</p>
<p> Turn the dial.</p>		<p>Set the required contact (here: Single charge).</p>
<p> Release the dial to store the setting.</p>		
<p> Press once and release.</p>		<p>Back to the next higher level.</p>

	Input range	Factory setting	Own input
External contact	Single charge Disinfection None	None	

13.10 Selection and set up of thermal disinfection



USER NOTE

This function cannot be carried out if you have selected the "UBA flow" or "EMS flow" setting under the "DHW" function (see page 85).

If you select the "Thermal disinfection", the DHW is brought to a temperature once a week, which is high enough to kill off germs (e.g. legionnaires' disease).

The DHW cylinder load pump and the DHW circulation pump run constantly during the disinfection process.

If you have selected "Thermal disinfection, yes", the disinfection commences according to factory settings or your own preferences:

Every Tuesday at 01.00 hrs to 70 °C.









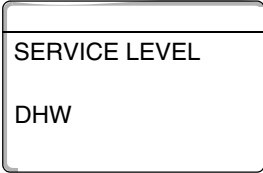

On modules FM 441 and FM 445 display the disinfection process via the LED display .

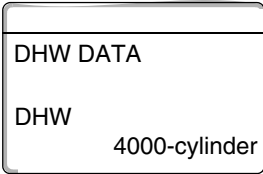
You may adjust the factory settings for thermal disinfection via further menus.

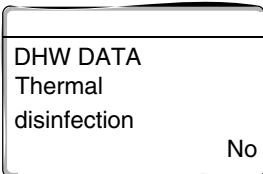

USER NOTE

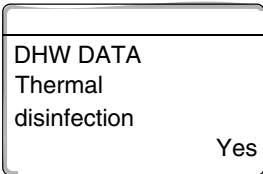
The "Thermal disinfection" function will not be displayed, if thermal disinfection has previously been set via the "External contact WF 1/3" function.

Step	Display	Comments/Notes
<p>Call up the service level.</p> <p> Turn the dial until "DHW" appears.</p>		<p>See "Calling up the service level" page 29.</p>
<p> Press and release the button.</p>		<p>The first menu item "DHW" appears.</p>
<p> Turn the dial until "Thermal disinfection" appears.</p>		
<p> Press and hold down the button.</p>		<p>The setting (here: No) flashes.</p>
<p> Turn the dial.</p>		<p>Set the required setting (here: Yes).</p>
<p> Release the dial to store the setting.</p>		
<p> Press once and release.</p>		<p>Back to the next higher level.</p>

	Input range	Factory setting	Own input
Thermal disinfection	Yes/No	No	

Setting the disinfection temperature

You can set the disinfection temperature via the "Disinfection temperature" function.











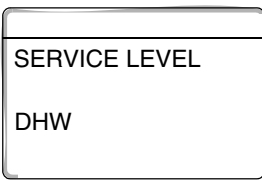

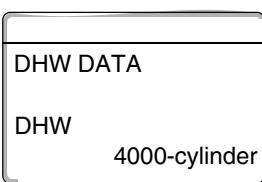
WARNING!

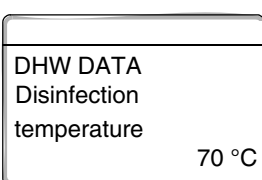
RISK OF SCALDING

by hot water in the DHW circuit of the heating system if it is not equipped with a thermostatic mixing valve.

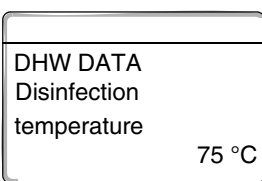
- **Inform your customer that during and immediately after thermal disinfection, DHW must not be turned on without mixing in cold water.**

Step	Display	Comments/Notes
Call up the service level.		See "Calling up the service level" page 29.
 Turn the dial until "DHW" appears.		
 Press and release the button.		The first menu item "DHW" appears.
 Turn the dial until "Thermal disinfection" appears.		
 Press and hold down the button.		The setting (here: 70 °C) flashes.
 Turn the dial.		Set the required setting (here: 75 °C).
 Release the dial to store the setting.		
 Press once and release.		Back to the next higher level.

	Input range	Factory setting	Own input
Disinfection temperature	60 – 75 °C	70 °C	









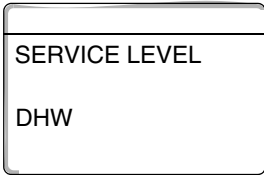

Set the day of the week for disinfection

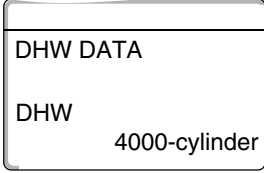
You can set the day of the week when disinfection should be carried out via the "Disinfection weekday" function.

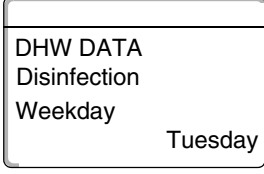

USER NOTE

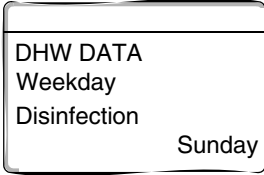
The "Disinfection weekday" function will not be displayed, if thermal disinfection has previously been set via the "External contact WF 1/3" function.

Step	Display	Comments/Notes
<p>Call up the service level.</p> <p> Turn the dial until "DHW" appears.</p>		See "Calling up the service level" page 29.
<p> Press and release the button.</p>		The first menu item "DHW" appears.
<p> Turn the dial until "Disinfection weekday" appears.</p>		
<p> Press and hold down the button.</p>		The setting (here: Tuesday) flashes.
<p> Turn the dial.</p>		Set the required day (here: Sunday).
<p> Release the dial to store the setting.</p>		
<p> Press once and release.</p>		Back to the next higher level.

	Input range	Factory setting	Own input
Disinfection weekday	Monday – Sunday	Tuesday	









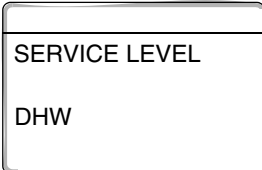

Set the time of day for disinfection

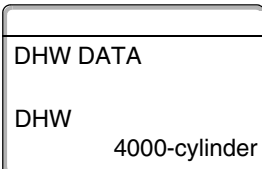
You can set the time of day when the disinfection should be carried out via the "Disinfection time" function.

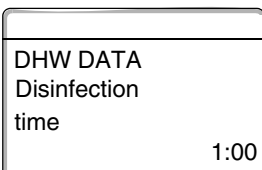

USER NOTE

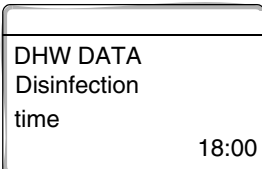







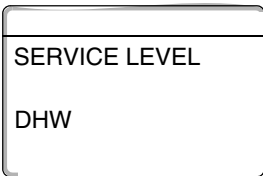

The "Disinfection time" function will not be displayed, if thermal disinfection has previously been set via the "External contact WF 1/3" function.

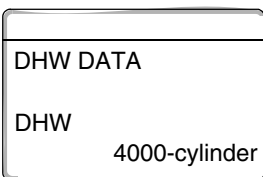
Step	Display	Comments/Notes
<p>Call up the service level.</p>  Turn the dial until "DHW" appears.		See "Calling up the service level" page 29.
 Press and release the button.		
 Turn the dial until "Disinfection time" appears.		The first menu item "DHW" appears.
 Press and hold down the button.		The fault indicator (here: 1.00) flashes.
 Turn the dial.		Set the required fault indication (here: 18.00 h).
 Release the dial to store the setting.		
 Press once and release.		Back to the next higher level.

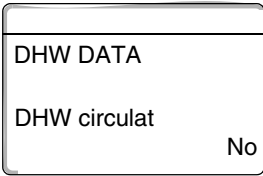
	Input range	Factory setting	Own input
Disinfection time	0 – 23:00 hrs	1 h	

13.11 Select the circulation pump

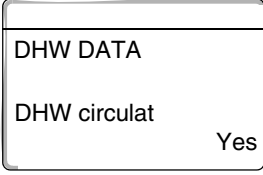
You can determine that DHW is immediately available at all tap via the "DHW circulat" function.

Step	Display	Comments/Notes
Call up the service level.		See "Calling up the service level" page 29.
 Turn the dial until "DHW" appears.		
 Press and release the button.		The first menu item "DHW" appears.
 Turn the dial until "DHW circulat" appears.		
 Press and hold down the button.		The setting (here: No) flashes.
 Turn the dial.		Set the required setting (here: Yes).
 Release the dial to store the setting.		
 Press once and release.		Back to the next higher level.

	Input range	Factory setting	Own input
DHW circulation	Yes/No	Yes	

Setting the DHW circulation pump intervals

You can reduce operating costs of the DHW circulation pump using the intermittent operation.

You can determine that DHW is immediately available at the taps, using the "DHW circulat per hour" function.

The set interval applies during that time in which the time program enables the DHW circulation pump. This program may be:

- The factory DHW circulation pump program
- Your own DHW circulation pump program
- A connection to the heating circuit switching times









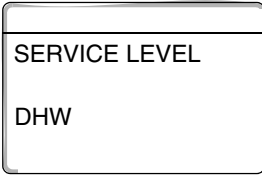

In "Perm. operation" the DHW circulat pump operates all day and is switched OFF during night operation.

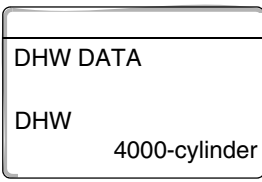
Example:

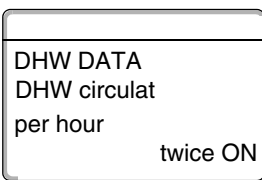
Your own time program was entered, which switches the DHW circulation pump ON for the period from 5:30 – 22.00 h with the setting "Circulation per hour TWICE ON".

The DHW circulation pump is switched ON respectively in cycles

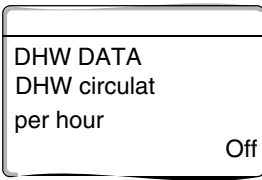
- at 05.30 h for 3 minutes,
- at 06.00 h for 3 minutes,
- at 06.30 h for 3 minutes,
- etc. until 22.00 h.

Step	Display	Comments/Notes
Call up the service level.		See "Calling up the service level" page 29.
 Turn the dial until "DHW" appears.		
 Press and release the button.		The first menu item "DHW" appears.
 Turn the dial until "Circulation per hour" appears.		
 Press and hold down the button.		The setting (here: twice ON) flashes.
 Turn the dial.		Set the required setting (here: OFF).
 Release the dial to store the setting.		The DHW circulation pump will now only operate during single loading.
 Press once and release.		Back to the next higher level.

	Input range	Factory setting	Own input
DHW circulation per hour	Off 1 to 6 times ON Constant operation	Twice ON	

13.12 Switching off the DHW circulation pump during DHW loading

If the LAP module FM445 is installed, you can switch the circulation on/off during DHW loading.



USER NOTE

The function "circulation OFF DHW charging" can only be used if the LAP module FM445 is installed.

Step	Display	Comments/notes
Call up the service level. Turn the dial until "DHW" appears.		See "Call up the service level" on page 29.
Press and release the button.		The first menu item "DHW" appears.
Turn the dial until "Circulation OFF DHW charging" appears.		
Press and hold down the button.		The setting (here: Yes) flashes.
Turn the dial.		Set the required setting (here: No).
Release the dial to store the setting.		
Press once and release.		Back to the next higher level.





	Input range	Factory setting	Own input
Circulation OFF DHW loading	Yes/no	Yes	

14 Heating Parameters

Using the "Heating charact." menu you can display the current heating characteristics of the relevant heating circuit.

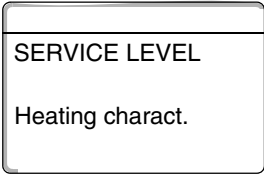
For explanations on the heating characteristic, see Chapter 22.2 "Heating curves", page 136.

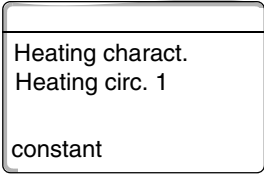
The flow temperatures (VL), which depend on the outside temperature (AT), are displayed.

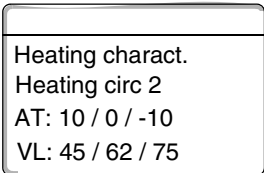
Step	Display	Comments/Notes
<p>Call up the service level.</p>  Turn the dial until "Heating charact." appears.		<p>See "Calling up the service level" page 29.</p>
 Press and release the button.		<p>The first menu item "Heating circ. 1" appears.</p>
 Turn the dial until the required heating circuit appears.  Press once.		<p>The settings for the selected heating circuit are displayed.</p> <p>Back to the next higher level.</p>

15 Testing the relay

You can check with the "Relay test" menu, whether you have correctly connected the external components (e.g. pumps).

The display depends on which modules are installed. Depending on the actual operating conditions, there may be a time-delay between request and display.



CAUTION!

SYSTEM DAMAGE

The system heat flow is not guaranteed whilst a relay test is being carried out. The control system deactivates all functions.

Leave this function after the relay test to prevent system damage.

Relay test example:

You may call up the following relays:

Heating circ. 1 – 4

- Heating circuit pump

- Valve







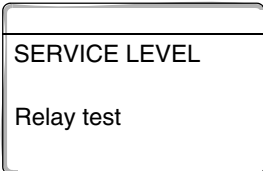

DHW

- Cylinder loading pump

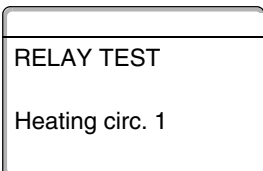
- DHW circ. pump

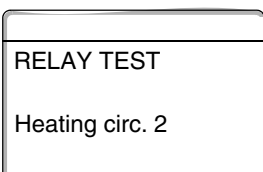
FM 456/FM 457

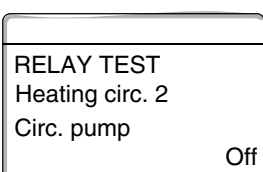
- Fault indication relays

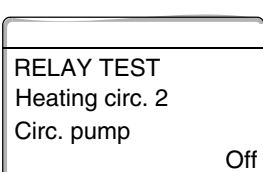
Step	Display	Comments/Notes
Call up the service level.		See "Calling up the service level" page 29.
 Turn the dial until "Relay test" appears.		
 Press and release the button.		The first menu item "Heating circ. 1" appears.
 Turn the dial until the required menu item appears.		The first menu item appears (here: Heating circ. 2).
 Press until the required relay appears.		
 Press and hold down.		The first setting (here: OFF) flashes.



Turn the dial until the required setting appears.



Release the dial to store the setting.



Press once.

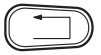

Press once.

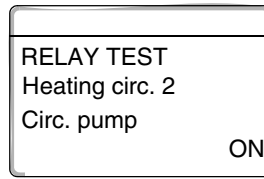

The setting of the selected relay (here: ON) flashes.

Back to the next higher level (relay test).

Back to the next higher level (service level).







USER NOTE

All relay test settings are cancelled at the end of the test.

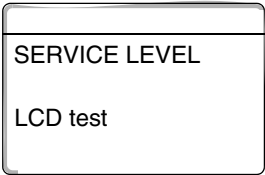
16 Carrying out an LCD test

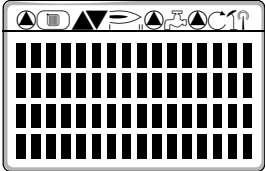





Using the "LCD test" menu, you can check, whether all symbols are fully displayed.

Step	Display	Comments/Notes
<p>Call up the service level.</p>  <p>Turn the dial until "LCD test" appears.</p>		<p>See "Calling up the service level" page 29.</p>
 <p>Press and release the button.</p>		<p>The LCD is OK, when all symbols are correctly displayed.</p>
 <p>Press once.</p>		<p>Back to the next higher level.</p>

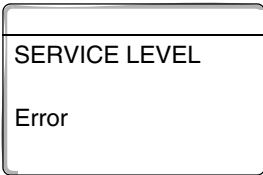
17 Error

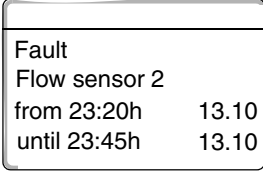
Using the "Error" menu you can display the last four fault messages for the heating system.

The MEC 2 can only display the fault messages of that control unit to which it is attached.

Step	Display	Comments/Notes
<p>Call up the service level.</p>  Turn the dial until "Error" appears.		<p>See "Calling up the service level" page 29.</p>
 Press and release the button.		<p>The fault message will then be displayed.</p>
 Turn the dial and scroll through the last fault messages.		<p> USER NOTE The display will show "No fault" if the connected control unit has not recorded any faults.</p>
 Press once.		<p>Back to the next higher level.</p>

If the control unit has recorded fault messages, these will be displayed together with the time for the beginning and end of the fault.

17.1 Fault displays

The following faults can be displayed:

- Outs. temp. sensor
- Flow sensor x
- DHW sensor
- DHW cold
- DHW warning
- Disinfection
- Remote control x
- Communication HKx
- Burner x
- External fault ES
- ECOCAN BUS receive
- No master
- BUS addr confl
- Address confl x
- False module x
- Unknown module x
- Inert anode
- Ext. fault input
- DHW sensor WT (External Heat Exchange) (LAP)
- DHW sensor OFF
- Connection boiler x
- Sensor low loss header
- Valve
- Manual mode XX
- Solar calb. X man. op (only if using solar FM443 currently not available in the UK)
- Maintenance hours run
- Maintenance date
- EMS fault, boiler x
- EMS fault, DHW
- Maintenance, boiler x

Fault	Effects on the Control characteristics	Possible causes for the fault	Remedy
Outside sensor	<ul style="list-style-type: none"> - The minimum outside temperature is assumed. 	<ul style="list-style-type: none"> - The outside sensor is either incorrectly connected, e.g. not to control unit with address 1 in cascade systems, not connected at all, or faulty. - The central module or control unit is faulty. - The communication to the control unit with address no. 1 is interrupted. 	<ul style="list-style-type: none"> ● Verify whether the outside sensor has been connected to the correct control unit (in cascade systems to the control unit with address no. 1). ● Check the communication with address 1. ● Replace the outside sensor or the central module.
Flow sensor x	<ul style="list-style-type: none"> - The valve is not being controlled. 	<ul style="list-style-type: none"> - The sensor is incorrectly connected, not connected at all, or faulty. The control unit requires the appropriate flow sensor if an valve was selected in MEC 2. - The module or control unit is faulty. 	<ul style="list-style-type: none"> ● Check the sensor connection. ● If the faulty heating circuit should be operated without a valve, check in MEC 2 / Service Level / Heating circ., whether valve: "No" has been selected. ● Replace the module.
DHW sensor	<ul style="list-style-type: none"> - No domestic hot water is produced. 	<ul style="list-style-type: none"> - The sensor is incorrectly connected, not connected at all, or faulty. - The module or control unit is faulty. 	<ul style="list-style-type: none"> ● Check the sensor connection. ● Replace the sensor or module. ● Check the sensor mounting on the DHW cylinder.
DHW stays cold	<ul style="list-style-type: none"> - The system tries constantly to load the domestic hot water cylinder. 	<ul style="list-style-type: none"> - Thermostat/manual switch is not set to "AUT". - The sensor is incorrectly connected or faulty. - Incorrect sensor arrangement. - The loading pump is incorrectly connected or faulty. - The module ZM424 or control unit is faulty. 	<ul style="list-style-type: none"> ● Check whether the thermostat or the manual switch is set to "AUT". ● Check the sensor and loading pump functions. ● Replace the module ZM424. ● Check the sensor mounting on the DHW cylinder.
DHW cold	<ul style="list-style-type: none"> - No domestic hot water is produced. Current DHW temperature is below 40 °C. 	<ul style="list-style-type: none"> - Load pump faulty. - Function module ZM424 faulty. - More DHW is removed than newly heated. 	<ul style="list-style-type: none"> ● Check whether the thermostat or the manual switch is set to "AUT". ● Check the sensor and load pump functions. ● Replace module ZM424. ● Check the sensor mounting on the DHW cylinder.
Disinfection	<ul style="list-style-type: none"> - Thermal disinfection was terminated. 	<ul style="list-style-type: none"> - The boiler output is insufficient, for instance, because other heat consumers (heating circuits) demand heat during the thermal disinfection. - The sensor is incorrectly connected or faulty. - The loading pump is incorrectly connected or faulty. - The module or control unit is faulty. 	<ul style="list-style-type: none"> ● Select disinfection, so that no other heat demand is made at that time. ● Check the sensor and loading pump function and replace, if necessary.
Remote control x	<ul style="list-style-type: none"> - Because no actual room temperature is available, the effect of the following features are disabled: ambient influence, switch-ON and switch-OFF optimisation and automatic adaptation. - The control unit works with the last setting set via the remote control. 	<ul style="list-style-type: none"> - Remote control incorrectly connected or faulty. 	<ul style="list-style-type: none"> ● Check the function and connection of the remote control. Check the remote control address. ● Replace the remote control / function module.

Tab. 3 Fault table

Fault	Effects on the Control characteristics	Possible causes for the fault	Remedy
Communication HKx	<ul style="list-style-type: none"> – Because no actual room temperature is available, the effect of the following features are disabled: ambient influence, switch-ON and switch-OFF optimisation and automatic adaptation. 	<ul style="list-style-type: none"> – An incorrect address was allocated to the remote control. – The remote control is incorrectly wired up. – The remote control is faulty. – The remote control is faulty. 	<ul style="list-style-type: none"> ● Check the function and connection of the remote control. Check the remote control address. ● Replace the remote control / function module.
Boiler x	<ul style="list-style-type: none"> – The boiler protection (frost protection) is not assured. – No domestic hot water. – No heating. 	<ul style="list-style-type: none"> – The UBC reports an interlocked error. 	<ul style="list-style-type: none"> ● Press the burner reset button. ● Check the UBA wiring. ● Check the wall-mounted boiler; see technical documentation for wall-mounted boilers.
Boiler x Status: Display code/ service code	<ul style="list-style-type: none"> – The boiler protection (frost protection) is not assured. – No domestic hot water. – No heating. 	<ul style="list-style-type: none"> – EMS boiler reports a locking fault with display code and service code 	<ul style="list-style-type: none"> ● See the boiler documentation for a detailed description of the fault, and carry out the steps described there. ● Press "Reset" on the BC10.
Boiler x EMS fault	<ul style="list-style-type: none"> – The boiler protection (frost protection) is not assured. – No domestic hot water. – No heating. 	<ul style="list-style-type: none"> – EMS boiler reports a locking fault. 	<ul style="list-style-type: none"> ● Read the display and service code from the BC10. ● See table 6 on page 117 for a detailed description of the fault, and carry out the steps described there ● Press "Reset" on the BC10.
DHW EMS fault	<ul style="list-style-type: none"> – No domestic hot water. 	<ul style="list-style-type: none"> – EMS boiler reports a fault in the DHW function. 	<ul style="list-style-type: none"> ● Read the display and service code from the BC10. ● See table 5 on page 116 for a detailed description of the fault, and carry out the steps described there.
Boiler x Maintenance Hxx	<ul style="list-style-type: none"> – None – Service message, not a system fault 	<ul style="list-style-type: none"> – e.g. maintenance interval expired 	<ul style="list-style-type: none"> ● Maintenance required, see boiler documentation or maintenance messages overview table.
Boiler x in manual mode	<ul style="list-style-type: none"> – No automatic functions, e.g. heating program.. 	<ul style="list-style-type: none"> – Not a fault. 	<ul style="list-style-type: none"> ● If you no longer need to use manual mode, set the dials on the BC10 base controller to "Aut".
Ext. Fault x	<ul style="list-style-type: none"> – The control behaviour remains unaffected. 	<ul style="list-style-type: none"> – The fault input of the module was incorrectly activated. – Externally connected components are faulty or generate a fault signal. 	<ul style="list-style-type: none"> ● Check the function of external components and effect their repair / replacement.
ECOCAN BUS Reception	<ul style="list-style-type: none"> – The control behaviour remains unchanged. 	<ul style="list-style-type: none"> – The rotary encoder behind the MEC 2 in the control unit (on CM 431) has an incorrect address. – Example: system with control unit and rotary encoder set to position > 0. 	<ul style="list-style-type: none"> ● Check the setting of the rotary encoder: ● Setting 0: only 1 bus user present. ● Setting 1: master control unit (other BUS users are expected!). ● Setting > 1: another bus user is expected.
No master	<ul style="list-style-type: none"> – The boiler protection is not assured. – DHW priority is no longer possible. – The minimum outside temperature is expected. – It goes cold. 	<ul style="list-style-type: none"> – The master control unit (address 1) is switched OFF or no master (address 1) is available. 	<ul style="list-style-type: none"> ● Checking all bus user addresses. Address 1 must be allocated to the master control unit (rotary encoder behind the MEC 2 on CM 431 of the control unit). ● Checking the bus connection to address 1.

Tab. 3 Fault table

Fault	Effects on the Control characteristics	Possible causes for the fault	Remedy
BUS addr confl	<ul style="list-style-type: none"> - Bus communication is impossible. - All control functions requiring data exchange via the ECOCAN BUS can no longer be implemented. 	<ul style="list-style-type: none"> - There is more than one identical address. - Each address must only be allocated once in the ECOCAN bus network. 	<ul style="list-style-type: none"> ● Check the addresses of all BUS users (rotary encoder behind the MEC 2 on the CM 431 of the control unit).
Address confl x	<ul style="list-style-type: none"> - The functions of the module, where the address conflict exists, can no longer be carried out. However, communication of all other modules and control units via the ECOCAN BUS is still possible. 	<ul style="list-style-type: none"> - Module inside the wrong control unit: certain modules can only be used with specific ECOCAN addresses. - The boiler module ZM 424 and modules FM 456 and FM 457 must not be installed in any control unit with the address > 1. 	<ul style="list-style-type: none"> ● Check the control unit address.
False module x	<ul style="list-style-type: none"> - The module switches all outputs OFF and the corresponding error LED illuminates. 	<ul style="list-style-type: none"> - False module default in the MEC 2. - The wrong module is installed in the control unit. - The MEC 2, the corresponding module or the control unit is faulty. 	<ul style="list-style-type: none"> ● Checking module defaults at the MEC 2 service level. ● Check the modules installed in the control unit. ● Replace the MEC 2 or the module.
Unknown module x	<ul style="list-style-type: none"> - The module switches all outputs OFF and the corresponding error LED illuminates. 	<ul style="list-style-type: none"> - The controller software is too old to recognise the module. - The module/control unit is faulty. 	<ul style="list-style-type: none"> ● Checking the control unit version in the MEC 2. ● Replace the module.
Inert anode	<ul style="list-style-type: none"> - The control behaviour remains unchanged. 	<ul style="list-style-type: none"> - Voltage is applied to the external input WF 1/2. - The module or the control unit is faulty. 	<ul style="list-style-type: none"> ● Replace the inert anode.
External fault input	<ul style="list-style-type: none"> - The control behaviour remains unchanged. 	<ul style="list-style-type: none"> - Voltage is applied to the external input WF1/2. - The module or the control unit is faulty. 	<ul style="list-style-type: none"> ● Check external components (cylinder loading and DHW circulation pumps) and replace if necessary.
DHW sensor WT	<ul style="list-style-type: none"> - No domestic hot water is produced. 	<ul style="list-style-type: none"> - The sensor is incorrectly connected, not connected at all, or faulty. - The module FM 445 or the control unit is faulty. 	<ul style="list-style-type: none"> ● Check sensors. ● Replace the sensor(s) or module FM 445. ● Check sensor fittings.
DHW sensor OFF	<ul style="list-style-type: none"> - No domestic hot water is produced. 	<ul style="list-style-type: none"> - The sensor is incorrectly connected, not connected at all, or faulty. - The module FM 445 or the control unit is faulty. 	<ul style="list-style-type: none"> ● Check sensors. ● Replace the sensor(s) or module FM 445. ● Check sensor fittings.
Connection BRx	<ul style="list-style-type: none"> - The frost protection is not assured. - No domestic hot water is produced. - No heating output. 	<ul style="list-style-type: none"> - UBC incorrectly connected. - UBC switched off. - UBC faulty. - Module faulty. 	<ul style="list-style-type: none"> ● Check connection. ● Switch on UBC. ● Replace UBC. ● Replace the KSE module.
Sensor low lossheader	<ul style="list-style-type: none"> - On single boiler systems: flow temperature can drop below setting. - On cascade systems: only one boiler operational. 	<ul style="list-style-type: none"> - Sensor faulty. - Module ZM 424, FM 456 or FM 457 are faulty. - Sensor connected to the wrong module. 	<ul style="list-style-type: none"> ● Check sensors. ● Replace the module. ● Connect sensor to the module in slot 1.

Tab. 3 Fault table

Fault	Effects on the Control characteristics	Possible causes for the fault	Remedy
Manual mode XX	– Controller operates in manual mode.	– Perhaps a function module manual switch has not been set to "AUT".	● Set the corresponding function module manual switch to "AUT".
Solar calo. X man. op	– Solar calorifier X on solar module operating in manual mode.	– Perhaps the manual switch on function module FM443 has not been set to "AUT".	● Set the manual switch of function module FM443 to "AUT".
Maintenance hours run/date	– No effect on control behaviour.	– The specified period before the next maintenance has expired.	● Perform maintenance and then reset maintenance message.

Tab. 3 Fault table

17.2 Supplementary fault messages for boilers with EMS

Reading off status (display code) and service code

If a fault occurs, the status is displayed on the control panel. The display flashes when a disabling safety shut-down occurs.

- Press "Status display" to read off the service code.
- Press "Status display" several times to display other service information until the boiler's status is displayed once more.

DHW EMS faults

DC: Display code (status)

SC: Service code

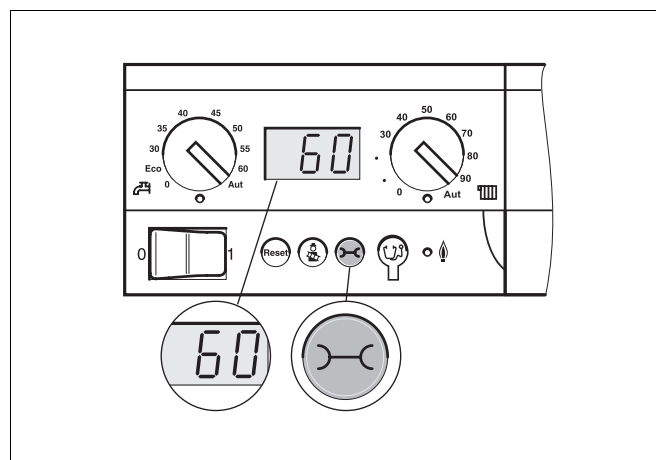

Fig. 18 Reading off display and service code (e.g. Logamatic MC10 control panel/BC10 base controller)

DC	SC	Fault	Effects on control characteristics	Possible causes of the fault	Remedy
A01	808	DHW sensor faulty	– No DHW being charged.	– Sensor incorrectly connected or faulty. – Sensor cable broken or short-circuited. – Old sensor.	● Check DHW sensor connection and change if necessary.
A01	810	DHW remains cold.	– The boiler keeps trying to charge the DHW cylinder. – The solar heating system does not start.	– Constant drawing or system leak. – Sensor incorrectly connected or faulty. – Sensor cable broken or short-circuited. – Old sensor. – Load pump connected incorrectly or faulty.	● Repair the leak. ● Check DHW sensor connection and change if necessary. ● Check the sensor and load pump functions. ● Check the sensor mounting on the DHW cylinder.

Tab. 4 Possible messages when DHW EMS faults occur

DC	SC	Fault	Effects on control characteristics	Possible causes of the fault	Remedy
A01	811	Thermal disinfection	– Thermal disinfection was stopped.	<ul style="list-style-type: none"> – Constant drawing or system leak. – Sensor incorrectly connected or faulty. – Sensor cable broken or short-circuited. – Old sensor. – Load pump connected incorrectly or faulty. 	<ul style="list-style-type: none"> ● Repair the leak. ● Check DHW sensor connection and change if necessary. ● Check the sensor and load pump functions. ● Check the sensor mounting on the DHW cylinder.

Tab. 4 Possible messages when DHW EMS faults occur

EMS faults

DC	SC	Fault	Effects on control characteristics	Possible causes of the fault	Remedy
AD 1	817	Air temperature sensor faulty.	– Fan speed cannot be properly adjusted.	– This fault message is generated if the air temperature sensor records a temperature that is too low (less than –30 °C) or too high (greater than +100 °C)	<ul style="list-style-type: none"> ● Check the air temperature sensor incl. the plug-in connection on the SAFE and replace if necessary.
AD 1	818	The boiler remains cold.	– Not enough power reaching heating system.	– This fault message appears if the boiler stays below the pump logic temperature (47 °C) for a certain length of time, even though the burner is ON.	<ul style="list-style-type: none"> ● Check the system design and the pump parameters and correct if necessary. ● Check the non-return valve is functioning properly and retrofit if necessary. ● Check whether gravity brakes are in working position..
AD 1	819	Continuous oil pre-heater signal	– The burner attempts to start.	– The oil pre-heater receives an enable signal, even though it is switched OFF.	<ul style="list-style-type: none"> ● Check the pin assignment on the SAFE and the oil pre-heater and correct if necessary.
AD 1	820	Oil too cold.	– The burner attempts to start.	– The oil pre-heater does not transmit the signal within six minutes that the oil has reached its operating temperature.	<ul style="list-style-type: none"> ● Check the electrical connection of the oil pre-heater; if OK, replace the oil pre-heater.

Tab. 5 Possible messages when EMS faults occur



USER NOTE

Other faults are described in the documents relating to the individual boiler.

17.3 Maintenance messages on boilers with EMS (only Oil)

DC: Display code (status)

SC	Maintenance	Possible cause	Remedy	EMS with boiler
H 1	Flue gas temperature too high	As soon as the flue gas temperature has exceeded a certain limit (110 °C), the burner is switched to stage 1, and this service message is generated. The message will only be cleared when the command "Reset service message" is issued.	<ul style="list-style-type: none"> ● Clean the boiler. ● Check the position, equipment level and state of the turbulator insert and correct if necessary. 	SAFe
H 2	The burner fan runs too slowly	The SAFe must generate an unusually high PWM signal for the required speed.	<ul style="list-style-type: none"> ● Check the burner fan for contamination and clean or replace if necessary. 	SAFe
H 3	Hours run expired	Does not occur with this control panel.		SAFe
H 4	Low flame probe current	<p>The flame signal is only just above the SAFe shutdown threshold.</p> <ul style="list-style-type: none"> – Flame sensor or holding bracket (on G135) is dirty. – Mixing system incorrectly oriented in relation to sight tube. – Faulty flame sensor/SAFe electrical connection. – Flame sensor or SAFe faulty. 	<ul style="list-style-type: none"> ● Check the flame sensor and holding bracket (mirror) for contamination and clean if necessary. ● Check the orientation of the mixing system in relation to the sight tube and correct if necessary. ● Check the mixing system for contamination and clean if necessary. ● Check the flame sensor plug-in connections on the SAFe. ● Check the burner adjustment and correct if necessary. ● Check the flame sensor signal for stage 1 and 2 using the RC30 . If not OK, replace the flame sensor. 	SAFe
H 5	Long ignition delay	<p>When the burner was last started, there was a long delay before ignition:</p> <ul style="list-style-type: none"> – Faulty oil supply. – Faulty ignition system. – Faulty burner adjustment. – Faulty burner components. 	<ul style="list-style-type: none"> ● Check oil supply. ● Check the ignition using a relay test (RC30); check the ignition electrode for contamination or damage (electrode gap) and replace if necessary. ● Replace the oil nozzle. ● Replace the oil cut-off valve of the oil pre-heater. ● Check the mixing system and clean if necessary. ● Check and correct burner adjustment if necessary. 	SAFe

Tab. 6 Maintenance messages

17 Only for Oil Boilers – Error

SC	Maintenance	Possible cause	Remedy	EMS with boiler
H 6	Frequent flame blow-off	<p>During the previous burner starts, the flame frequently blew off.</p> <ul style="list-style-type: none"> – Faulty oil supply. – Faulty ignition system. – Faulty burner adjustment. – Faulty burner components. 	<ul style="list-style-type: none"> ● Read out the fault memory of blocking faults to check in which phase the flame blew off. <p>If only 6U/511 (no flame established) is present:</p> <ul style="list-style-type: none"> ● Check oil supply. ● Check the flame sensor current using RC30 . ● Check the ignition via a relay test (RC30). ● Replace the oil nozzle. ● Replace the oil cut-off valve of the oil pre-heater. ● Check the mixing system and clean if necessary. ● Check and correct burner adjustment if necessary. <p>If other blocking faults are present (flame blow-off after the flame was established successfully):</p> <ul style="list-style-type: none"> ● Check the burner adjustment and correct if necessary. ● Check the oil supply equipment . ● Check the pin assignments of 1st/2nd solenoid valve (fault 6L/516). ● Check the flame probe current during operation. If signal < 50 µA, check the holding bracket (on G135) and clean if necessary or replace the flame sensor. 	SAFe
H 7	System pressure	The operating pressure has fallen too low.	Top up heating water until the operating pressure > 1.0 bar.	UBA3
H 8	According to date	Does not occur with this control panel.		SAFe

Tab. 6 Maintenance messages

18 Low loss header monitor data

Using the "Monitor" menu you can display the set and actual settings. The display depends on which modules are installed.







Some display settings are separated by a slash (/). The number in front of the slash determines the setting of each respective parameter and the figure behind the slash is the actual setting.

You can display data for the following components:

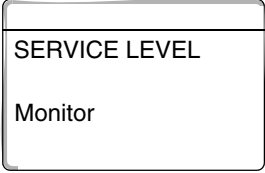
- Low loss header
- Boiler
- Heating circ.
- DHW

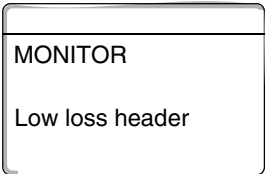

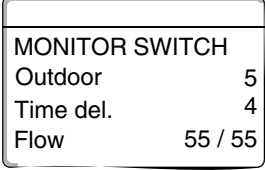





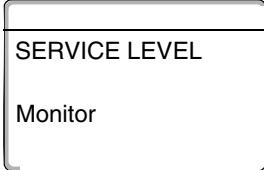

18.1 Low loss header monitor data

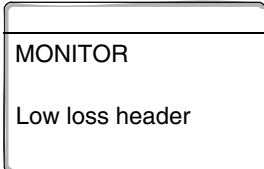
Using the Monitor menu "Low loss header" you can display the low loss header data.

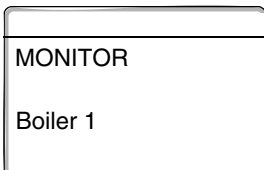
Step	Display	Comments/Notes
Call up the service level.		See "Calling up the service level" page 29.
 Turn the dial until "Monitor" appears.		
 Press and release the button.		The first menu item "Low loss header" appears.
 Press and release the button.		The low loss header data are then displayed. The "Time del." setting describes the outdoor temperature, taking the type of building into consideration which has already been entered, and with which the heating curves were calculated.
 Press once.		Back to the next higher level.

18.2 Boiler monitor data

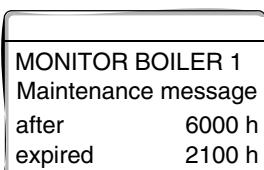
Using the Monitor menu "Boiler" you can display the boiler data.

Step	Display	Comments/Notes
<p>Call up the service level.</p>		<p>See "Calling up the service level" page 29.</p>
<p> Turn the dial until "Monitor" appears.</p>		
<p> Press and release the button.</p>		<p>The first menu item "Low loss header" appears.</p>
<p> Turn the dial until "Boiler 1" appears.</p>		
<p> Press and release the button.</p>		<p>The "Time del." setting describes the outdoor temperature, taking the type of building into consideration which has already been entered, and with which the heating curves were calculated.</p>
<p> Turn the dial to scroll through the boiler monitor data.</p>		<p>Other boiler monitor data is displayed according to the boiler type.</p> <p>See the following tables for descriptions.</p>
<p> Turn the dial again. Finally, any maintenance messages are displayed.</p>	<p>Example: Maintenance message according to hours run (or according to date)</p> 	<p> USER NOTE</p> <p>The maintenance message "after hours run" is only applicable when there is only one boiler.</p> <p>The maintenance message "according to date" is only displayed under boiler 1, but applies to all boilers.</p>
<p> Press once.</p>		<p>Back to the next higher level.</p>

Boiler monitor data for boilers with UBA 1.x

See page 121 for operating instructions.

Display	Explanation	Unit	Range
Outdoor	Outdoor temperature	°C	
time del.	adjusted outdoor temperature, taking the type of building which has been entered into consideration, to calculate the heating characteristic	°C	
ext. heat demand	setting for the boiler flow temperature, only with function module FM456 or FM457 (see page 20)	°C	
Flow	flow temperature set/actual setting	°C	
Return	return temperature/actual setting	°C	
Starts	number of burner starts		
Status	current operating status		
KIM no.	Boiler type (KIM = boiler identification module)		
UBA version	software version of the universal burner control units		
Output	current boiler output	%	0 – 100
Max. output	maximum approved boiler output	%	0 – 100
Pump	current output of the boiler pump for modulating pumps or switching state for single-stage pumps	%	% 0 – 100 or on/of

Tab. 7 Boiler monitor data for boilers with UBA 1.x

Boiler monitor data for boilers with EMS/UBA3

See page 121 for operating instructions.

Display	Explanation	Unit	Range
Outdoor	actual outdoor temperature	°C	
time del.	adjusted outdoor temperature, taking the type of building which has been entered into consideration, to calculate the heating characteristic	°C	
ext. heat demand	setting for the boiler flow temperature, only with function module FM456 or FM457 (see page 20)	°C	
Flow	flow temperature set/actual setting	°C	
Return	return temperature actual setting	°C	
Starts	number of burner starts		
Status	current operating status		
Service code	Service code for identifying the status message		
KIM	Boiler type and KIM version (KIM = boiler identification module)		
UBA3	software version of the universal burner control units		
Output	current boiler output	%	0 – 100
Max. output	maximum approved boiler output	%	0 – 100 or EMS DHW
Pump	current output of the boiler pump for modulating pumps or switching state for single-stage pumps	%	% 0 – 100 or on/of

Tab. 8 Boiler monitor data for boilers with EMS/UBA3

Maximum	maximum boiler output		kW	
Max. output	upper modulation limit		%	0 – 100
Min. output	lower modulation limit		%	0 – 100
Flue gas	actual flue gas temperature		°C	
Air	actual combustion air temperature		°C	
Pressure	actual heating system operating pressure		bar	
Flame current	actual flame current	} Oil Boilers	µA	>100, if less change the flame ignition
Ignition	Ignition			on/off
Flame	Flame			on/off
Valve 1	Burner valve stage 1	} Oil Boilers		open/closed
Valve 2	Burner valve stage 2			open/closed

Tab. 8 Boiler monitor data for boilers with EMS/UBA3

Boiler monitor data for boilers with EMS/SAFe







See page 122 for operating instructions.

Display	Explanation	Unit	Range	
Outdoor	actual outdoor temperature	°C		
time del.	adjusted outdoor temperature, taking the type of building which has been entered into consideration, to calculate the heating characteristic	°C		
ext. heat demand	setting for the boiler flow temperature, only with function module FM456 or FM457 (see page 20)	°C		
Flow	flow temperature set/actual setting	°C		
Return	return temperature actual setting	°C		
Starts	number of burner starts			
Status	current operating status			
Service code	Service code for identifying the status message			
BIM	Burner type and BIM version (BIM = burner identification module)			
MC10	software version of the Logamatic MC10 control panel			
SAFe	Type and software version of the SAFe burner control units			
Output	current boiler output	%	0 – 100	
Max. output	maximum approved boiler output	%	% 0 – 100 or EMS DHW	
Pump	current output of the boiler pump for modulating pumps or switching state for single-stage pumps	%	% 0 – 100 or on/of	
Maximum	maximum boiler output	kW		
Max. output	upper modulation limit	%	0 – 100	
Min. output	lower modulation limit	%	0 – 100	
Flue gas	actual flue gas temperature	°C		
Air	actual combustion air temperature	°C		
Pressure	actual heating system operating pressure	bar		
Flame current	actual flame current	} Oil Boilers	µA	
Ignition	Ignition			on/off
Flame	Flame			on/off
Valve 1	Burner valve stage 1	} Oil Boilers		open/closed
Valve 2	Burner valve stage 2			open/closed

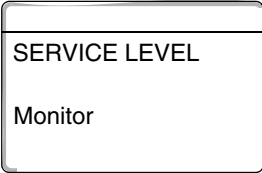
Tab. 9 Boiler monitor data for boilers with EMS/SAFe

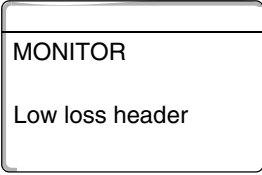
18.3 Heating circuit monitor data

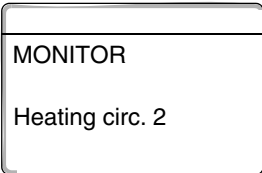
Using the monitor menu "Heating circ" you can display the data for one heating circuit.

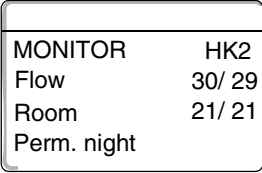
Step	Display	Comments/Notes
<p>Call up the service level.</p>		<p>See "Calling up the service level" page 29.</p>
<p> Turn the dial until "Monitor" appears.</p>		
<p> Press and release the button.</p>		<p>The first menu item "Low loss header" appears.</p>
<p> Turn the dial until the required "Heating circ" appears.</p>		
<p> Press and release the button.</p>		<p>The setting and the actual setting for the flow room temperature are displayed.</p>
		<p>The last line displays one of the following operating modes:</p> <ul style="list-style-type: none"> - Perm. night - Perm. day - Auto night - Auto day - Holiday - Summer - ON optimisation - OFF optimisation - Cement (screed) - DHW priority



Turn the dial to scroll through the heating circuit monitor data.

MONITOR	HK2
Design adapter	75
ON opt.	15 min
OFF opt.	30 min



Turn the dial to scroll through the heating circuit monitor data.

MONITOR	HK2
Actuator	50%
Circ. pump	OFF



Press once.

Design temperature adaptation

This setting displays the design temperature calculated by adaptation.

Switch-ON optimisation

A calculated period, by which the heating system starts its heating operation prior to the actual switching point, so that the set room temperature is reached by the actual start-up time.

Switch-OFF optimisation

A calculated period to commence an early setback to save energy.

Valve

indicates the calculated regulating pulse in percent.

Example:

- 0% = no control command.
- 50 % = valve is commanded in a cycle of 10 seconds, i.e. 5 seconds towards "Open valve" (hotter).
- 100% = valve is commanded in a cycle of 10 seconds, i.e. 10 seconds towards "Close valve" (colder) (constant).

Pump







indicates the operating condition of the pump.

Back to the next higher level.

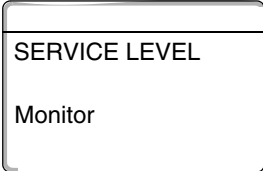
18.4 DHW monitor data

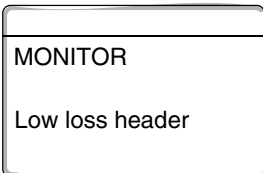
Using the Monitor menu "DHW" you can display the data relating to the DHW settings.

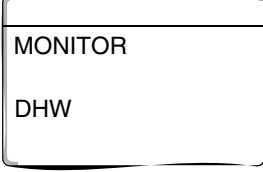
The displays depend on the settings selected under the "DHW" function.

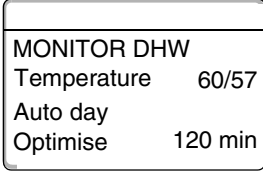
Step	Display	Comments/Notes
<p>Call up the service level.</p>		<p>See "Calling up the service level" page 29.</p>
<p> Turn the dial until "Monitor" appears.</p>		
<p> Press and release the button.</p>		<p>The first menu item "Low loss header" appears.</p>
<p> Turn the dial until "DHW" appears.</p>		
<p> Press and release the button.</p>		<p>Temperature</p> <p>The calculated setting and the actual setting for the domestic hot water temperature are displayed.</p> <p>Possible operating modes:</p> <ul style="list-style-type: none"> - Off - Perm operation - Auto night - Auto day - Holiday - Optimisation - Disinfection - Re-loading <p>Optimise</p> <p>indicates the period, by which the system commences producing domestic hot water before the actual switching point, to achieve the domestic hot water setting in good time.</p>



Turn the dial to scroll through the DHW monitor data.

MONITOR DHW	
Charging	OFF
DHW circulat.	ON



Turn the dial to scroll through the DHW monitor data.

MONITOR DHW	
Sensor ON	50/48
Sensor OFF	55/30
Sensor WT	60/60



Turn the dial to scroll through the DHW monitor data.

MONITOR DHW	
Primary pump	80%
Second. pump	100%
Mix. valve pos.	100%



Press.

Charging

indicates the operating condition of the DHW cylinder load pump.

DHW circulation

indicates the operating condition of the DHW circulation pump.



USER NOTE

These DHW data are only displayed, if module FM 445 was selected under "Module selection".

ON = Temp sensor – central

OFF = Temp sensor – bottom

WT= Temp heat exchanger sensor

The position of the valve indicates a setting between 0 % (closed) and 100 % (open).







USER NOTE

These DHW data are only displayed, if module FM 445 was selected under "Module selection".

Back to the next higher level.

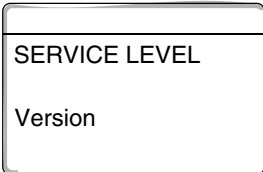

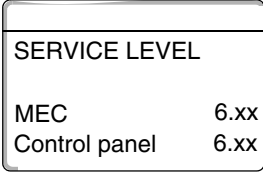



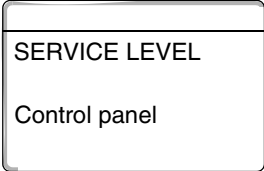

19 Display version

Using the "Version" menu you can display version of the MEC 2 as well as that of the selected control unit.

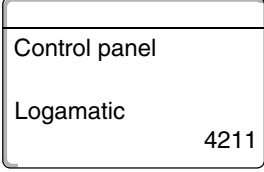
Step	Display	Comments/Notes
<p>Call up the service level.</p>  <p>Turn the dial until "Version" appears.</p>		<p>See "Calling up the service level" page 29.</p>
 <p>Press and release the button.</p>		<p>The version no. for the MEC and the control unit are displayed.</p>
 <p>Press once.</p>		<p>Back to the next higher level.</p>

20 Selecting the control unit

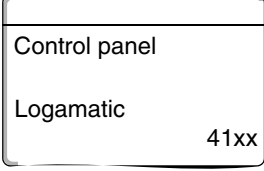
With the "Control panel" menu you can select a control unit, if the **MEC 2 is operated offline**, i.e. without connected control unit or with a separate power supply unit.

Step	Display	Comments/Notes
<p>Call up the service level.</p>  Turn the dial until "Control panel" appears.		<p>See "Calling up the service level" page 29.</p>
 Press button.		<p>The control unit will be displayed.</p>
 Press and hold down		<p>The setting (here: 4211) flashes.</p>
 Turn the dial to the required control unit type.		
 Release the dial to store the setting.		
 Press once.		<p>Back to the next higher level.</p>

21 Reset

21.1 Resetting control unit parameters

With the menu "Reset factory settings" you can change all settings of the operator or service level to the factory default values.





All values are automatically reset.



USER NOTE

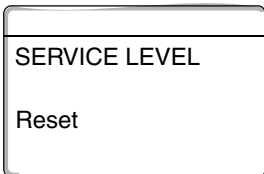

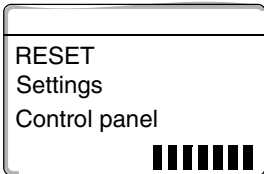



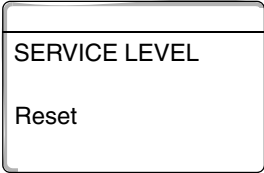

All control unit settings at the operator and service levels are reset to factory settings.

The time switch is not included in the reset. Any set variations remain unchanged, even after the reset.

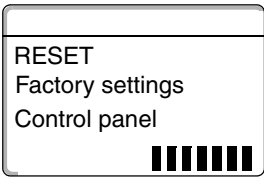
Step	Display	Comments/Notes
<p>Call up the service level.</p> <p> Turn the dial until "Reset" appears.</p>		<p>See "Calling up the service level" page 29.</p>
<p> Press and hold down the button.</p>		<p>The blocks in the last line disappear one after the other. All settings are reset after the final block has disappeared.</p> <p>The reset operation will be terminated if you release the button before all blocks have disappeared.</p>
<p> Release the button.</p>		<p>Back to the next higher level.</p>

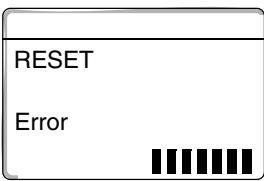
21.2 Reset the error

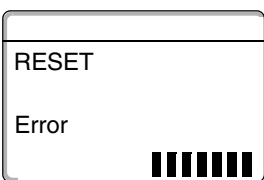
Using the "Reset error" function you can reset the whole fault memory. This deletes all entries into the error log.

Step	Display	Comments/Notes
<p>Call up the service level.</p>		<p>See "Calling up the service level" page 29.</p>
<p> Turn the dial until "Reset" appears.</p>		
<p> Press button.</p>		<p>Then the menu item "Reset factory settings" is displayed.</p>
<p> Turn the dial until "Reset Error" appears.</p>		
<p> Press and hold down the button.</p>		<p>The blocks in the last line disappear one after the other. The error log is reset after the final block has disappeared.</p>
<p> Release the button.</p>		<p>The reset operation will be terminated if you release the button before all blocks have disappeared. Back to the next higher level.</p>

21.3 Resetting the maintenance message









After maintenance is completed, the maintenance message must be reset. This means that the maintenance message no longer appears if the flap is closed.

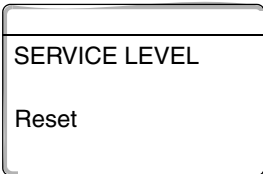

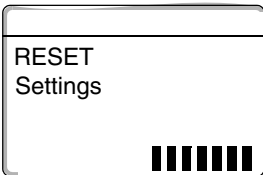
USER NOTE

Resetting the maintenance message restarts the maintenance interval.

Please note that with maintenance messages set according to date, the next maintenance date will be fixed at one year in the future.

Step	Display	Comments/Notes
 <p>Call up the service level. Turn the dial to "Reset".</p>		<p>See "Calling up the service level" page 29.</p>
 <p>Press button.</p>		<p>The menu item "Reset factory settings" is displayed</p>
 <p>Turn the dial to "Reset Maintenance message"</p>		
 <p>Press and hold down the button.</p>		<p>The blocks in the last line disappear one after the other. The maintenance message is reset after the final block has disappeared.</p>
 <p>Release the button.</p>		<p>The reset operation will be terminated if you release the button before all blocks have disappeared. Back to the next higher level.</p>

22 Sensor curves

22.1 Sensor curves

- Isolate the system before taking any readings.

You can check using the diagram, whether temperature and resistance correlate.

Error checking (without room temperature sensor)

- Remove the sensor terminals.
- Check the resistance at the sensor cable ends using an Ohmmeter.
- Check the sensor temperature with a thermometer.

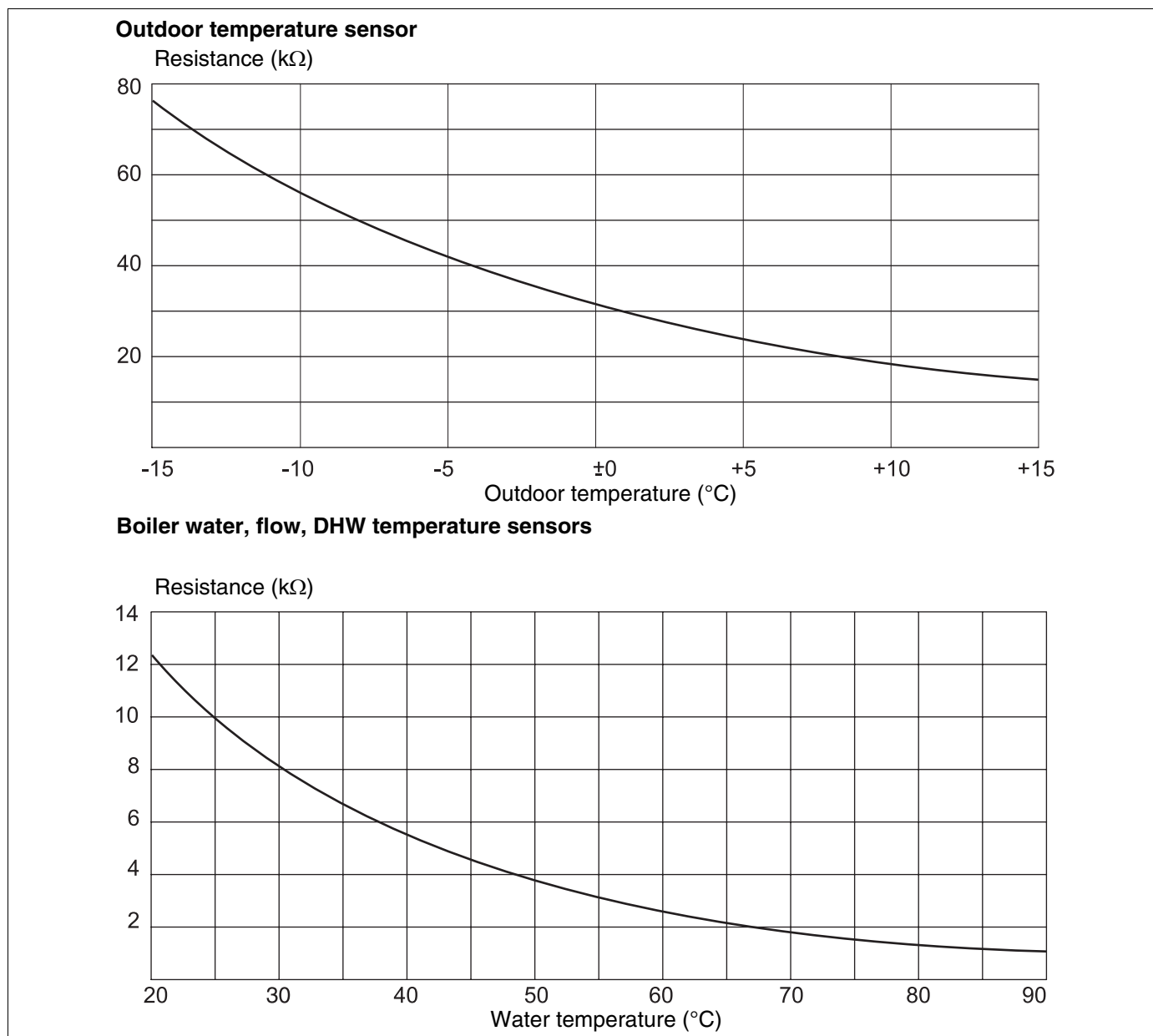
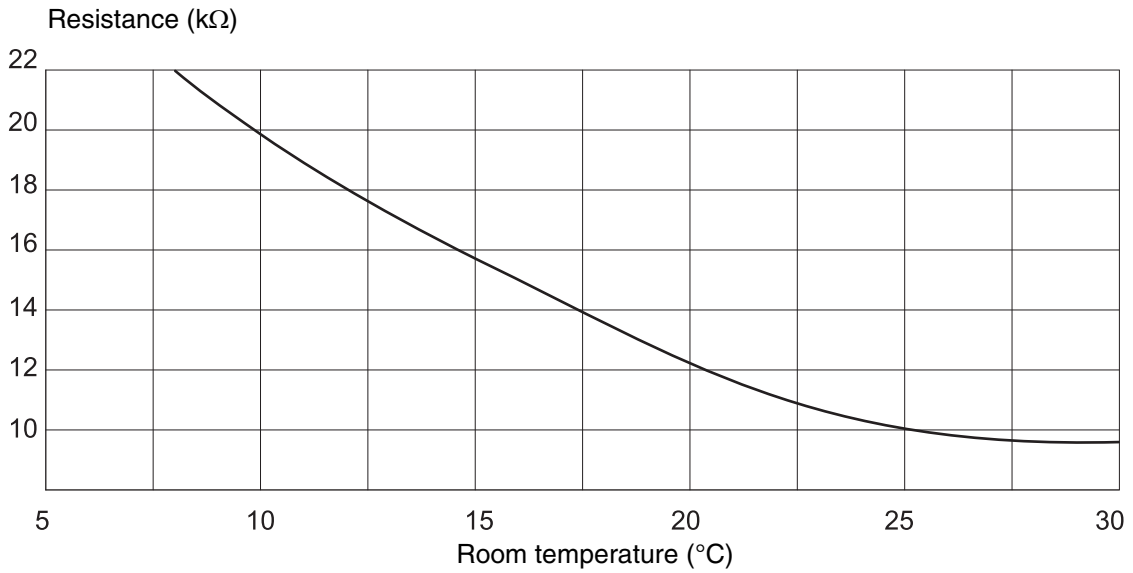

Fig. 19 Outside temperature sensor and boiler water, flow, DHW temperature sensors

Room temperature sensor



Flue gas temperature sensor

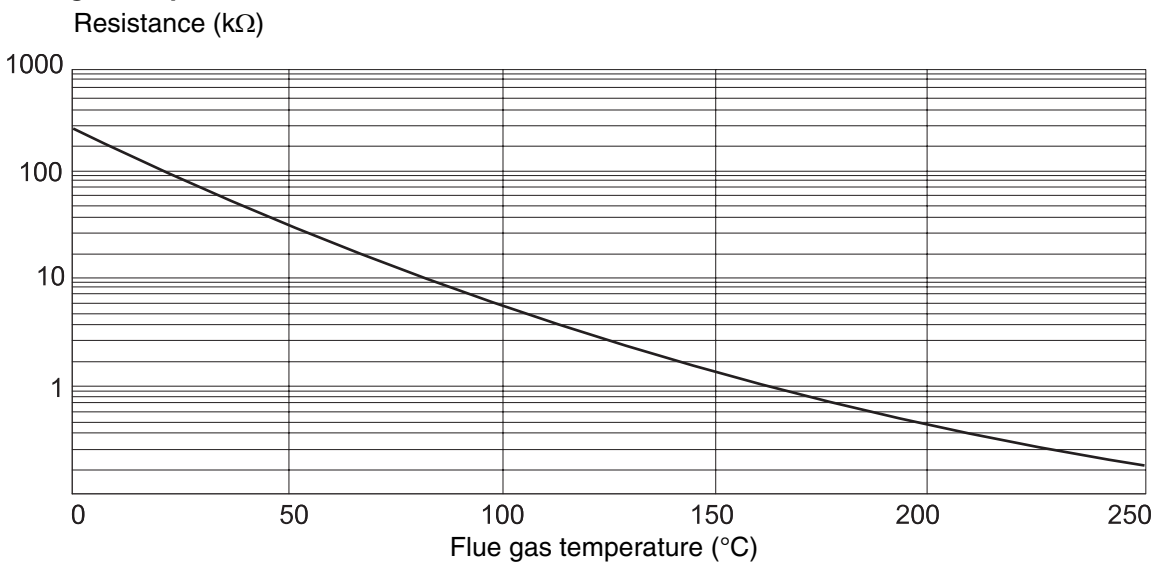

Fig. 20 Room temperature and flue gas temperature sensors

We reserve the right to make any changes due to technical modifications.

22.2 Heating curves

Notes on adjusting the heating curve:

You can adjust the heating curve gradient using the design point. The design point consists of the minimum outdoor temperature for the region and the design temperature of the selected heating system (e.g. radiators).

The heating curve moves in parallel as you adjust the required room temperature. If you change the room temperature by 1 K, the flow temperature changes by approx. 3 K.

Figure 21 shows how heating curve (1) for design point $-10\text{ }^{\circ}\text{C}/75\text{ }^{\circ}\text{C}$ moves in parallel (2, 3 and 4) through various set room temperatures. Heating curves (5 and 6) show the changed gradient for other design points.

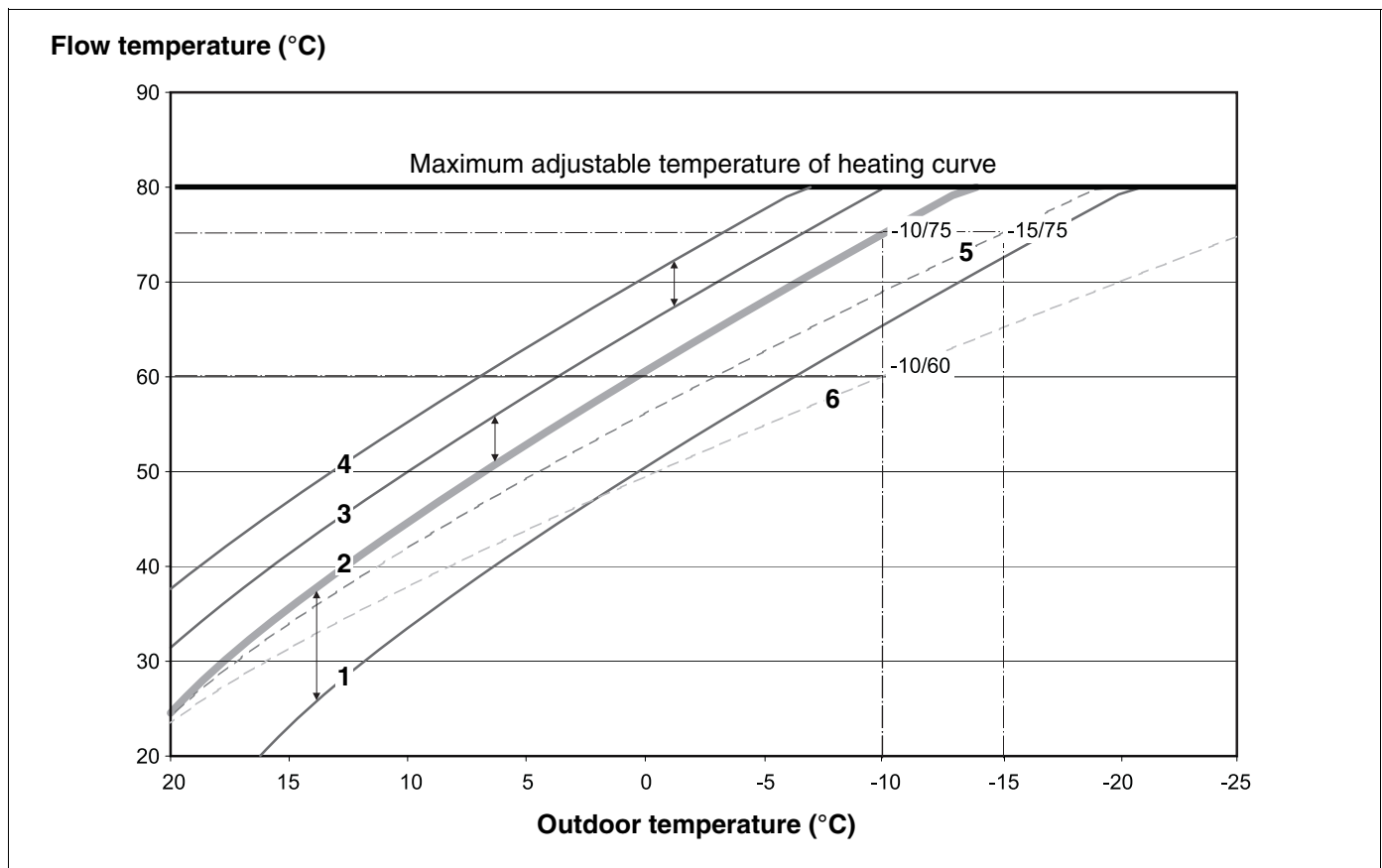

Fig. 21 Heating curve for a "radiator" heating system

- Item 1:** Set room temperature $17\text{ }^{\circ}\text{C}$, min. outdoor temperature $-10\text{ }^{\circ}\text{C}$, design temperature $75\text{ }^{\circ}\text{C}$
- Item 2:** Set room temperature $21\text{ }^{\circ}\text{C}$, min. outdoor temperature $-10\text{ }^{\circ}\text{C}$, design temperature $75\text{ }^{\circ}\text{C}$
- Item 3:** Set room temperature $23\text{ }^{\circ}\text{C}$, min. outdoor temperature $-10\text{ }^{\circ}\text{C}$, design temperature $75\text{ }^{\circ}\text{C}$
- Item 4:** Set room temperature $25\text{ }^{\circ}\text{C}$, min. outdoor temperature $-10\text{ }^{\circ}\text{C}$, design temperature $75\text{ }^{\circ}\text{C}$
- Item 5:** Set room temperature $21\text{ }^{\circ}\text{C}$, min. outdoor temperature $-10\text{ }^{\circ}\text{C}$, design temperature $75\text{ }^{\circ}\text{C}$
- Item 6:** Set room temperature $21\text{ }^{\circ}\text{C}$, min. outdoor temperature $-10\text{ }^{\circ}\text{C}$, design temperature $60\text{ }^{\circ}\text{C}$

23 Keyword Index

A	
Actual room temperature	67
Adjusting the setting	60
B	
Base point	53
Basic equipment	12
Boiler temperature	50, 96
Boiler type	47
Boiler type codes	22
C	
Cellar	55
Cement (screed)	78
Changeover between summer and winter	60
Changing the operating mode	60
Circulation pump intervals	106
CM 431	10
Constant	53
Control device address	10
Control panel	130
Controls	8
Convector heater	53
D	
Design temperature	57
DHW	85
DHW circulation pump	105, 107
DHW functions	19
DHW priority	74
Disinfection	98
Disinfection temperature	102
Domestic hot water functions	13, 15
E	
EMS/SAFE	22
EMS/UBA 3	22
Error	112, 132
F	
Faults	113
Flow setback	66
Flow temperature	59
FM 441	14
FM 442	16
FM 445	18, 91, 92, 93
FM 456	20
FM 457	20
Frost protection temp.	73
G	
General Data	32
H	
Heating charact.	108
Heating circ. no	55
Heating circ. valve	75
Heating circ., apartment	55
Heating circ., bath	55
Heating circ., building	55
Heating circ., swimming pool	55
Heating circuit functions	13, 15, 17, 19, 21
Heating circulate data	53
Heating system	53
Holiday function	60
Hysteresis	90
I	
Increasing boil.	77
Input 0 - 10V	20
Inserted modules	8
J	
Jumper block	21
L	
LCD test	111
Low loss header	121
M	
Manual control fault message	38
Max flow temp.	59
Max room infl	62
MEC 2 programmer	25
Module selection	41
Monitor data	121

N

Night setback with room temperature stop60
 No. of boilers42

O

Offset67
 Optimisation69
 Optimisation, DHW87

P

Party function60
 Password29
 Pause function60

R

Radiator53
 RC3024
 Relay test109
 Reload the cylinder90
 Remote control60
 Remote control without display (BFU)60
 Remote system37
 Rename the heating circuit55
 Reset131
 Reset all settings.131
 Rest heat use88
 Room53
 Room controller53

S

Select the heating system53
 Select the remote control60
 Sensor curves134
 Sequence contrl51
 Set the low end56
 Set the outside stop temperature65
 Setback type63
 Setting parameters7
 Single load98

T

Thermal disinfection100
 Type of building32
 Type of setback, outside stop65

U

UBA22
 Under53
 Under floor55
 Under floor heating53, 55
 Universal burner control22

V

Valve75
 Version129

W

Water connection85

Z

ZM 42412

Your installer:

Buderus

Buderus
Cotswold Way, Warndon, Worcester WR4 9SW
Tel.: 01905 752794, Fax: 01905 753130
www.buderus-commercial.co.uk

BBT Thermotechnik GmbH
D-35573 Wetzlar
www.heiztechnik.buderus.de
info@heiztechnik.buderus.de

In the UK, Buderus is a trading name of
BBT Thermotechnology Ltd.