

USER'S GUIDE

Installation of this appliance must be carried out by a competent installer who will install it according to the proper norms and procedures.

The installation of this appliance must be in accordance with the relevant requirements of the Gas Safety (Installation & Use) Regulations (1984), the Local Building Regulations, the current I.E.E. Wiring Regulations, the by-laws of the local water undertaking, and in Scotland, in accordance with the Building Standards (Scotland) Regulation. Health and safety document n5 635 "Electricity at work regs. 1989".

In order to take full advantage of the quality built into your boiler, we suggest that you consult the manual before use. Keep this guide and the manual handy since you may need it in the future.

The boiler has been designed for supplying your central heating and domestic hot water directly.

Gaining access to the the control panel

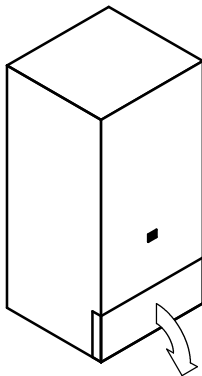
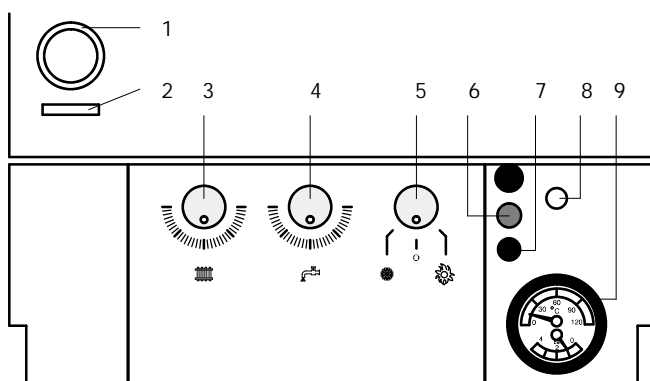

fig. 1.1

To reach the control panel rotate the small panel as indicated in fig. 1.1.

Control panel



- 1 Time Switch (barrel)
- 2 Time Switch function selector
- 3 Central heating (c.h.) temperature adjustment
- 4 Domestic hot water (d.h.w.) temperature adjustment
- 5 Function switch
- 6 Shut-down warning light
- 7 Reset push-button
- 8 Overheat thermo-stat reset push-button
- 9 Main circuit temperature-pressure gauge

To operate the appliance

Before lighting the appliance, check central heating system pressure.

It must be at least 1 bar gauge (14,5 p.s.i.).

If it is below this do not light the appliance but consult your installer for checking and refilling the system.

Lighting the appliance

- Ensure that gas supply cock, c.h. cocks and d.h.w. cock (located on the bottom of the appliance) are open.
- Switch on the mains electricity.

Operating domestic hot water

- Turn the function switch "5" in  position;

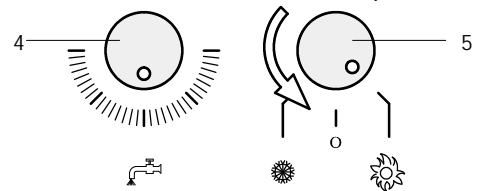

- open hot water tap.

The boiler will now go through an ignition sequence and the burner will light.

Use temperature adjustment "4" () for setting the desired temperature.

The adjustment knob can be set between 35 °C minimum and 65 °C.

Set the temperature of domestic hot water to the temperature you require during actual use. This minimizes the necessity of mixing cold water with water which is too hot, and takes full advantage of the automatic temperature regulation system.

If the flow through the cock on the domestic hot water system is too great, the hot water will not be adequately heated. If this occurs, call an authorized service technician, who will install a flow limiter.

Please note: with the function switch "5" in  position the Time Switch doesn't run.

Operating heating + domestic hot water

- Turn the function switch "5" in  position;

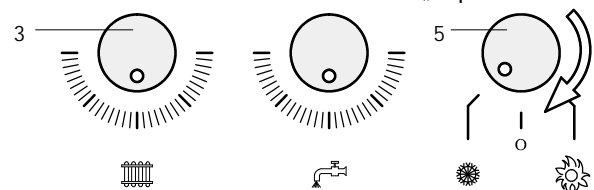

- switch on the Time Switch (position "1" see section *Time Switch*);
- adjust room temperature control devices (room thermostat, thermostatic radiator valves) to high settings.

The boiler will now go through an ignition sequence and the burner will light.

Use temperature adjustment "3" () for setting the desired temperature.

To obtain the maximum degree of economy and comfort, we advise adjusting the temperature of c.h. water to suit the outside temperature.

User's guide

When c.h. is operating, the circulation will be interrupted when d.h.w. is being drawn off. This will normally not affect the level of heating.

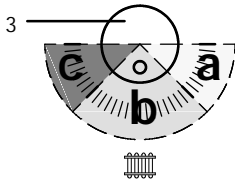

- a** For outside temperature from +15 to +5 °C
i.e **spring – autumn**
- b** For outside temperature from +5 to –5 °C
i.e **mid winter**
- c** For outside temperature less than –5 °C
i.e **severe cold weather**

Time Switch

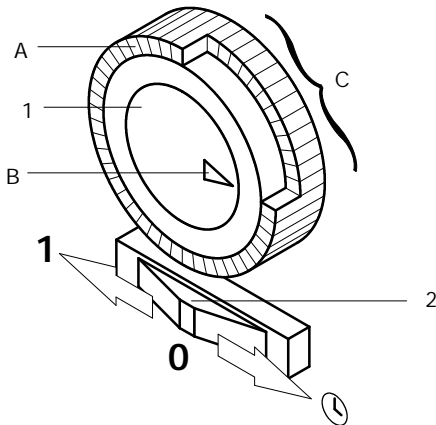

This boiler is provided with a Time Switch "1" which permits you to program the central heating cycle of the boiler during a 24 hour period.

Please note: the Time Switch "1" operates the central heating cycle only. With the function switch "5" in  or "0" position the Time Switch doesn't run.

To enter the time

Turn the clock barrel "A" in clockwise direction until the indicator "B" corresponds with the current time showed on the barrel.

To enter the activity periods of the heating

Press in the areas ("C" in the figure) corresponding with the time in which the heating is requested. Any individual area corresponds to a 15 minutes time span.

Function selector

With the function selector "2", it is possible to select the function of the Time Switch without moving the pattern already selected.

With the selector in position "1" (left) the central heating function is switched on continuously and it is controlled only by the room thermostat (if fitted).

With the selector in position "0" (central) the central heating function is totally switched off.

With the selector in position "🕒" (right) the central heating function is switched on during the pattern set on the time switch.

To shut down the appliance

For short periods turn the function switch "5" on "0" position.

For long periods switch off the mains electricity and close the gas supply cock.

If the appliance is to be shut down for long periods when there is risk of freezing, then the appliance should be drained.

Draining and refilling must be done by a competent person following approved procedures.

Electricity supply

WARNING – THIS APPLIANCE MUST BE EARTHED

This appliance requires a 240 V~ 50 Hz supply and should be protected by a 3 A fuse.

If a 3 A plug to BS 1363 is used or any other type of plug is used the circuit should be fused 3 A.

To connect a plug

As the colour of the wire in the mains lead of the appliance may not correspond with the coloured markings identifying the terminals in your plug, proceed as follows:

- the wire which is coloured green and yellow must be connected to the terminal in the plug which is marked with the letter E or by the symbol  or coloured green or green and yellow;
- the wire which is coloured blue must be connected to the terminal which is marked with the letter N or coloured black;
- the wire which is coloured brown must be connected to the terminal which is marked with the letter L or coloured red.

Cleaning outer casing

Use a clean damp cloth. Do not use abrasive cleaners. Control panel can be wiped with damp cloth and dried. Spray polishes must not be used on control panel surface or knobs.

Care must be taken in preventing any liquid entering the appliance.

Care of appliance and system

It is good practice to clean and service the appliance and central heating system every year.

Call an authorized Service Centre.

Safety lockout

If, one of the following faults occur during normal work:

- troubles on gas feeding;
- failure of the full sequence control;
- bad ignition;
- over-heat;

the boiler will go to lockout and the shut down warning light will appear.

To reset the boiler depress the reset push button "7" marked with the symbol: 

In the event of operating failure

If there is a fault with the appliance it must not be used until the fault is rectified by an authorized Service Centre.