

# **Instructions for the installer**

**Boilers mod.**

**120MFS**

**124MFS**

**120RFS**



**Savio**

# Important

## The manual...

must be read thoroughly, so that you will be able to use the boiler in a safe and sensible way;

must be carefully kept. It may be necessary for reference in the future.

## Installation...

must be carried out by a qualified person who will be responsible for observing the current Regulations.

## First lighting up...

must be carried out by a competent and responsible person; the guarantee is valid from the date it is carried out.

## Repairs...

(under guarantee)

must be carried out only by a competent and responsible person, using genuine spare parts. Thus do no more than switching off the boiler yourself (see the instructions).

## Your boiler...

allows heating up of water to a temperature less than the boiling point;  
must be connected to a central heating system and/or a hot water supply system, compatible with its performance and output;  
can be used only for those purposes for which it has been specially designed;  
must not be touched by children or by those unfamiliar with its operation;  
must not be exposed to the elements.

## The manufacturer...

disclaim all liability for any translations of the present manual from which incorrect interpretation may occur;

accepts no responsibility for unsatisfactory performance of the appliance and flue due to failure to comply the following instructions.



**This manual has been printed on recycled paper.  
A contribution to the protection of the environment.**

# TABLE OF CONTENTS

<b>1</b>	<b>General</b> .....	<b>2</b>	<b>3.8</b>	Joits .....	<b>19</b>
1.1	Overview .....	2			
1.2	Combined control panel .....	3			
1.3	Heating only control panel .....	3	<b>4</b>	<b>Commissioning</b> .....	<b>20</b>
1.4	Main diagram 120MFS, 124MFS ..	4	4.1	Electrical installation .....	20
1.5	Main diagram 120RFS .....	5	4.2	Gas supply installation .....	20
1.6	Technical data mod. 120MFS .....	6	4.3	Filling the D.H.W. system .....	20
1.7	Technical data mod. 124MFS .....	8	4.4	Initial filling of the system .....	20
1.8	Technical data mod. 120RFS .....	10	4.5	Lighting the boiler .....	21
1.9	Hydraulic specifications .....	12	4.6	Checking gas pressure at the burner	22
1.10	Expansion tank .....	12	4.7	Checking the flue system .....	22
			4.8	Checking the ignition device .....	22
<b>2</b>	<b>General requirements</b> .....	<b>13</b>	4.9	Selecting the circulator modes .....	23
2.1	Related documents .....	13	4.10	Adjusting the burner ignition .....	23
2.2	Location of appliance .....	13	4.11	Adjustment of useful c/h output .....	24
2.3	Flue system .....	13	4.12	Instructing the user .....	25
2.4	Gas supply .....	13			
2.5	Air supply .....	14	<b>5</b>	<b>Gas conversion</b> .....	<b>26</b>
2.6	Ventilation .....	14	5.1	Warnings .....	26
2.7	Water circulation (central heating) ..	14	5.2	Procedures .....	26
2.8	Domestic water .....	15			
2.9	Electrical supply .....	15	<b>6</b>	<b>Maintenance</b> .....	<b>27</b>
<b>3</b>	<b>Installation</b> .....	<b>16</b>	6.1	Warnings .....	27
3.1	Warnings .....	16	6.2	Dismantling the external panels .....	27
3.2	Precautions for installation .....	16	6.3	Emptying the d.h.w. system (Combination boilers only) .....	27
3.3	Installing the template .....	17	6.4	Emptying the central heating system	28
3.4	Mounting the boiler .....	17	6.5	Cleaning the primary heat exchanger	28
3.5	Fitting the exhaust fume duct .....	17	6.6	Checking the pressurisation in the expansion tank .....	28
3.6	Electrical connections .....	18	6.7	Cleaning the burner .....	28
3.7	Dimensions .....	19	6.8	Checking the exhaust duct .....	28

This appliance complies with the EEC directive 90/396 and, therefore, the use of the



mark is allowed.

It also complies with the EEC directive 87/308 relative to the prevention and elimination of radio interference.

This appliance is made in accordance with current European standards regarding the safety of gas appliances and safety in using electrical household appliances.

The manufacturer, in his continuous search to improve his products, reserves the right to modify the data given herein without prior notice.

This documentation is for information purposes only and is not to be considered a contract.

# 1 GENERAL

## 1.1 Overview

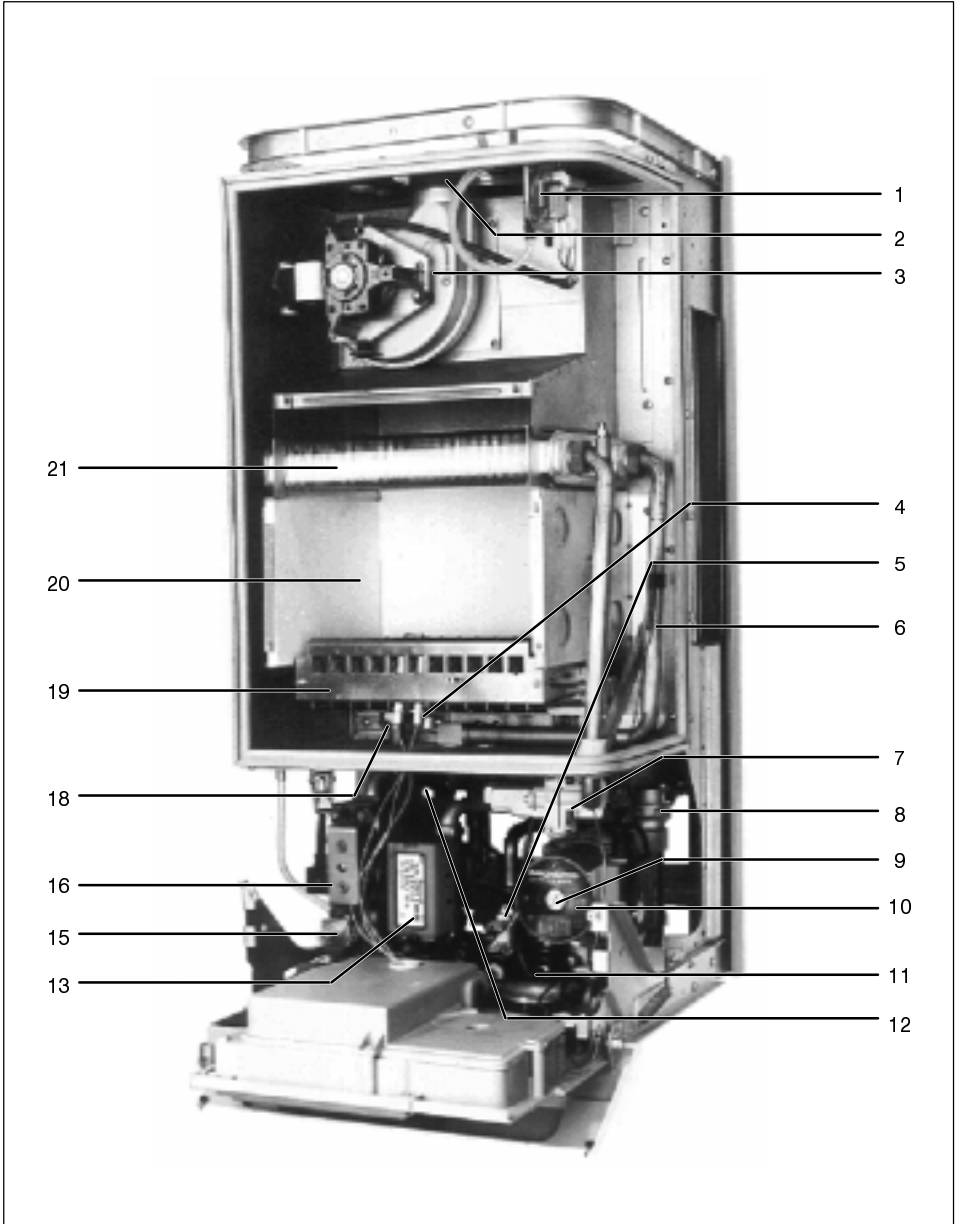

fig. 1.1

## General

- 1 Air pressure switch
- 2 Venturi device
- 3 Fan
- 4 Flame–detecting electrode
- 5 Domestic hot water flow switch
- 6 Safety thermostat
- 7 Central heating flow switch
- 8 Automatic bleed valve
- 9 Pump vent plug
- 10 Pump
- 11 Domestic hot water probe NTC
- 12 Central heating probe NTC
- 13 Three–way diverter valve
- 14 Gas valve inlet pressure tap
- 15 Modulation operator
- 16 Modulation gas valve
- 17 Gas valve outlet pressure tap
- 18 Ignition electrode
- 19 Burner
- 20 Combustion chamber
- 21 Primary heat exchanger
- 22 Manual bleed valve
- 23 Domestic hot water heat exchanger
- 24 By–pass
- 25 Domestic hot water filter
- 26 Domestic hot water flow limiter (optional)
- 27 Three–way diverter valve body
- 28 Expansion tank
- 29 Gas cock
- 30 Central heating return cock
- 31 Central heating flow cock
- 32 Cold water in cock
- 33 Domestic hot water out cock
- 34 3 bar pressure relief valve
- 35 Main circuit drain cock

- 36 Domestic hot water circuit drain cock
- 37 Flue outlet pipe
- 38 Air intake pipe

### 1.2 Combined control panel

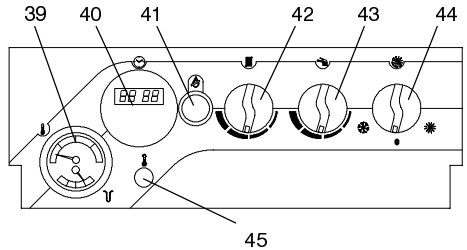

fig. 1.2

### 1.3 Heating only control panel

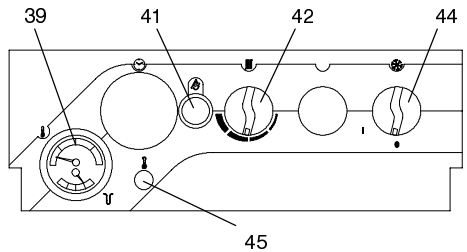

fig. 1.3

- 39 Central heating circuit temperature and pressure gauge
- 40 Time switch (central heating control)
- 41 Stop signal light and reset button
- 42 Central heating temperature adjustment knob
- 43 Domestic hot water temperature adjustment knob
- 44 Function switch
- 45 Safety thermostat reset button

**1.4 Main diagram**  
**120MFS, 124MFS**

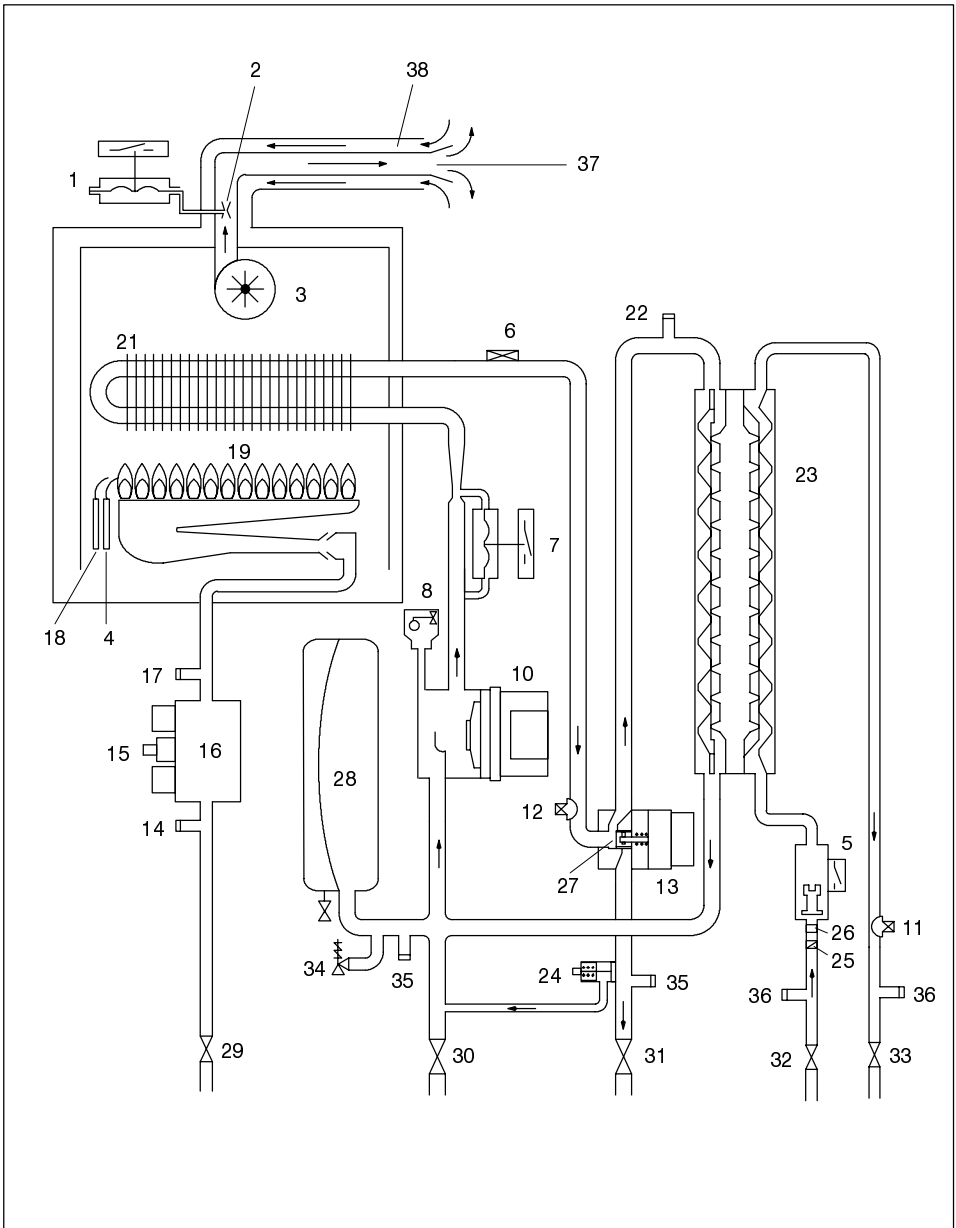

fig. 1.4 (key on page 3)

**1.5** Main diagram  
**120RFS**

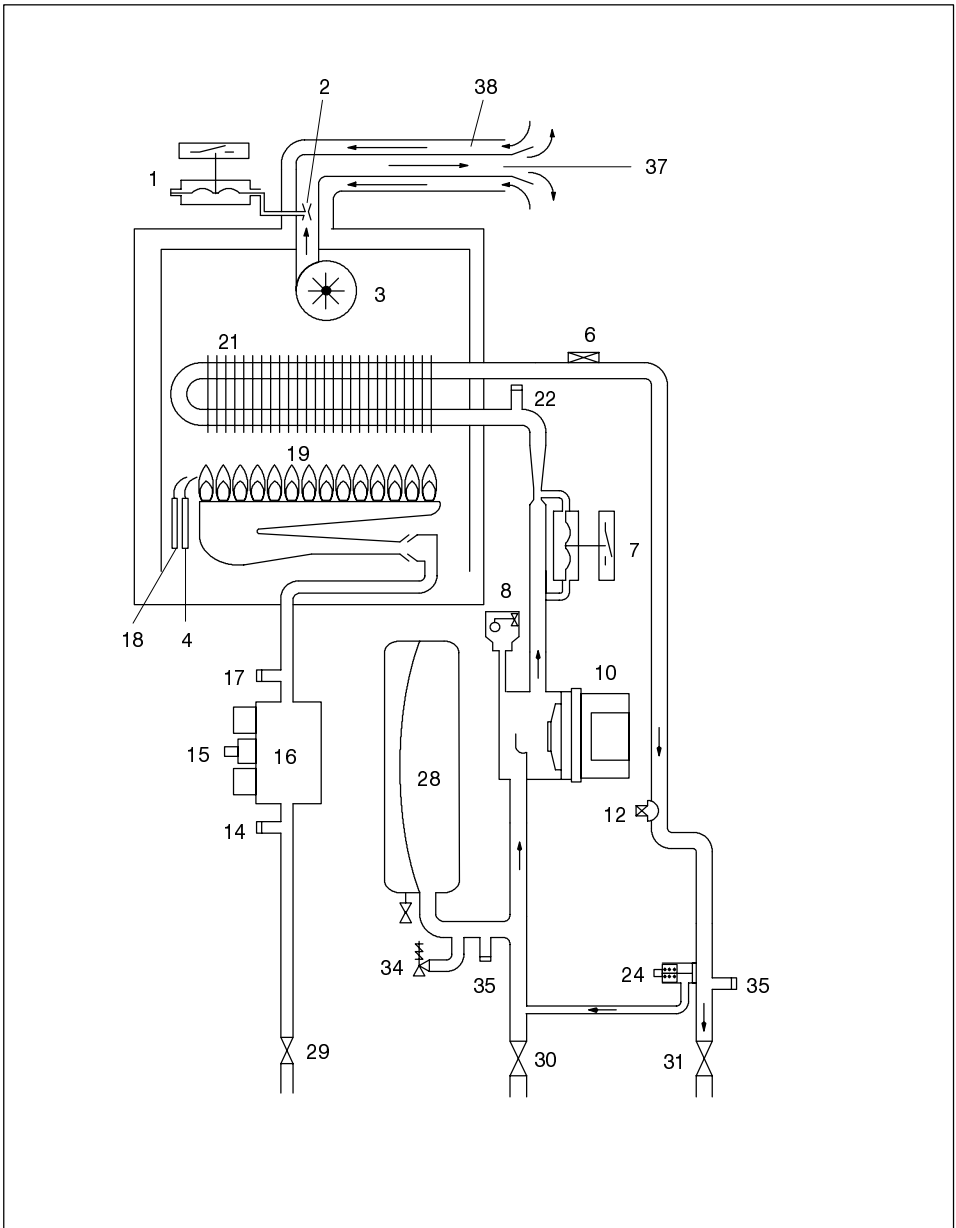

fig. 1.5 (key on page 3)

## General

### 1.6 Technical data mod. 120MFS

Nominal heat input	kW	25,84
	BTU/h	88 175
Minimum heat input	kW	11,00
	BTU/h	37 540
Maximum useful output	kW	23,26
	BTU/h	79 365
Minimum useful output	kW	9,16
	BTU/h	31 280

Central heating		
Maximum temperature	°C	90
Minimum temperature	°C	35
Maximum pressure	kPa	300
	bar	3
Minimum pressure	kPa	30
	bar	0,3
Available head (in 1000 l/h)	kPa	32
	bar	0,32

Domestic hot water		
Maximum temperature	°C	60
Minimum temperature	°C	37
Maximum pressure	kPa	1 000
	bar	10
Minimum pressure	kPa	20
	bar	0,2
Flow rate		
minimum	l/min	2
30° rise	l/min	11,1
35° rise	l/min	9,5
40° rise	l/min	8,3

Gas supply pressures				
Gas		norm.	min	max
Natural G20	Pa	2 000	1 700	2 500
	mbar	20	17	25
Butane G30	Pa	2 900	2 000	3 500
	mbar	29	20	35
Propane G31	Pa	3 700	2 500	4 500
	mbar	37	25	45

Maximum gas pressures at the burner		
Natural G20	Pa	950
	mbar	9,5
Butane G30	Pa	2 750
	mbar	27,5
Propane G31	Pa	3 550
	mbar	35,5
Maximum gas rate		
Natural G20	m <sup>3</sup> /h	2,73
Butane G30	kg/h	2,04
Propane G31	kg/h	2,00

Minimum gas pressures at the burner		
Natural G20	Pa	140
	mbar	1,4
Butane G30	Pa	480
	mbar	4,8
Propane G31	Pa	700
	mbar	7,0
Minimum gas rate		
Natural G20	m <sup>3</sup> /h	1,16
Butane G30	kg/h	0,87
Propane G31	kg/h	0,85

Injectors	
Natural G20	135
Butane G30	77
Propane G31	77

G 20 p.c.i. 35,9 MJ/m<sup>3</sup>

G 30 p.c.i. 45,6 MJ/kg

G 31 p.c.i. 46,4 MJ/kg

1 mbar approximately equals 10 mm H<sub>2</sub>O



---

## General

---

<b>Electrical Data</b>		
Voltage	V~	220–240
Frequency	Hz	50
Power consumption	W	150
Protection degree		IP44
External fuse rating	A	3
Internal fuse rating	A	1,6 T

<b>Flue data</b>		
Minimum venturi pressure	mbar	-1,4
Flue pipe diameter		
Coaxial	mm	60/100
Twin split pipes	mm	80
Roof	mm	80/120
Exhaust temperature*	°C	120
Smoke production*	kg/h	75
<i>* Values refer to tests with a 0,5 m chimney working at the nominal heat input</i>		

<b>Other specifications</b>		
Height	mm	853
Width	mm	400
Depth	mm	370
Weight	kg	49

## General

### 1.7 Technical data mod. 124MFS

Nominal heat input	kW	31,00
	BTU/h	105 794
Minimum heat input	kW	14,00
	BTU/h	47 777
Maximum useful output	kW	27,90
	BTU/h	95 238
Minimum useful output	kW	11,7
	BTU/h	40 130

<b>Central heating</b>		
Maximum temperature	°C	90
Minimum temperature	°C	35
Maximum pressure	kPa	300
	bar	3
Minimum pressure	kPa	30
	bar	0,3
Available head (in 1000 l/h)	kPa	32
	bar	0,32

<b>Domestic hot water</b>		
Maximum temperature	°C	60
Minimum temperature	°C	37
Maximum pressure	kPa	1 000
	bar	10
Minimum pressure	kPa	20
	bar	0,2
Flow rate		
minimum	l/min	2
30° rise	l/min	13,3
35° rise	l/min	11,4
40° rise	l/min	10,0

<b>Gas supply pressures</b>				
Gas		norm.	min	max
Natural G20	Pa	2 000	1 700	2 500
	mbar	20	17	25
Butane G30	Pa	2 900	2 000	3 500
	mbar	29	20	35
Propane G31	Pa	3 700	2 500	4 500
	mbar	37	25	45

<b>Maximum pressures at the burner</b>		
Natural G20	Pa	1 100
	mbar	11,0
Butane G30	Pa	2 650
	mbar	26,5
Propane G31	Pa	3 570
	mbar	35,7
<b>Maximum gas rate</b>		
Natural G20	m <sup>3</sup> /h	3,28
Butane G30	kg/h	2,45
Propane G31	kg/h	2,40

<b>Minimum pressures at the burner</b>		
Natural G20	Pa	180
	mbar	1,8
Butane G30	Pa	510
	mbar	5,1
Propane G31	Pa	670
	mbar	6,7
<b>Minimum gas rate</b>		
Natural G20	m <sup>3</sup> /h	1,43
Butane G30	kg/h	1,10
Propane G31	kg/h	1,09

<b>Injectors</b>	
Natural G20	130
Butane G30	77
Propane G31	77

G 20 p.c.i. 35,9 MJ/m<sup>3</sup>

G 30 p.c.i. 45,6 MJ/kg

G 31 p.c.i. 46,4 MJ/kg

1 mbar approximately equals 10 mm H<sub>2</sub>O

---

## General

---

<b>Electrical Data</b>		
Voltage	V~	220–240
Frequency	Hz	50
Power consumption	W	150
Protection degree		IP44
External fuse rating	A	3
Internal fuse rating	A	1,6 T

<b>Flue data</b>		
Minimum venturi pressure	mbar	–1,4
Flue pipe diameter		
Coaxial	mm	60/100
Twin split pipes	mm	80
Roof	mm	80/120
Exhaust temperature*	°C	120
Smoke production*	kg/h	90
<i>* Values refer to tests with a 0,5 m chimney working at the nominal heat input</i>		

<b>Other specifications</b>		
Height	mm	853
Width	mm	400
Depth	mm	370
Weight	kg	49

## General

### 1.8 Technical data mod. 120RFS

Nominal heat input	kW	25,84
	BTU/h	88 175
Minimum heat input	kW	11,00
	BTU/h	37 540
Maximum useful output	kW	23,26
	BTU/h	79 365
Minimum useful output	kW	9,16
	BTU/h	31 280

<b>Central heating</b>		
Maximum temperature	°C	90
Minimum temperature	°C	35
Maximum pressure	kPa	300
	bar	3
Minimum pressure	kPa	30
	bar	0,3
Available head (in 1000 l/h)	kPa	32
	bar	0,32

<b>Gas supply pressures</b>				
Gas		norm.	min	max
Natural G20	Pa	2 000	1 700	2 500
	mbar	20	17	25
Butane G30	Pa	2 900	2 000	3 500
	mbar	29	20	35
Propane G31	Pa	3 700	2 500	4 500
	mbar	37	25	45

<b>Maximum gas pressures at the burner</b>		
Natural G20	Pa	950
	mbar	9,5
Butane G30	Pa	2 750
	mbar	27,5
Propane G31	Pa	3 550
	mbar	35,5
<b>Maximum gas rate</b>		
Natural G20	m <sup>3</sup> /h	2,73
Butane G30	kg/h	2,04
Propane G31	kg/h	2,00

<b>Minimum gas pressures at the burner</b>		
Natural G20	Pa	140
	mbar	1,4
Butane G30	Pa	480
	mbar	4,8
Propane G31	Pa	700
	mbar	7,0
<b>Minimum gas rate</b>		
Natural G20	m <sup>3</sup> /h	1,16
Butane G30	kg/h	0,87
Propane G31	kg/h	0,85

<b>Injectors</b>	
Natural G20	135
Butane G30	77
Propane G31	77

G 20 p.c.i. 35,9 MJ/m<sup>3</sup>

G 30 p.c.i. 45,6 MJ/kg

G 31 p.c.i. 46,4 MJ/kg

1 mbar approximately equals 10 mm H<sub>2</sub>O

---

## General

---

<b>Electrical Data</b>		
Voltage	V~	220–240
Frequency	Hz	50
Power consumption	W	150
Protection degree		IP44
External fuse rating	A	3
Internal fuse rating	A	1,6 T

<b>Flue data</b>		
Minimum venturi pressure	mbar	–1,4
Flue pipe diameter		
Coaxial – wall	mm	60/100
Twin split pipes	mm	80
Coaxial – roof	mm	80/120
Exhaust temperature*	°C	120
Smoke production*	kg/h	75
<i>* Values refer to tests with a 0,5 m chimney working at the nominal heat input</i>		

<b>Other specifications</b>		
Height	mm	853
Width	mm	400
Depth	mm	370
Weight	kg	44,5

## 1.9 Hydraulic specifications

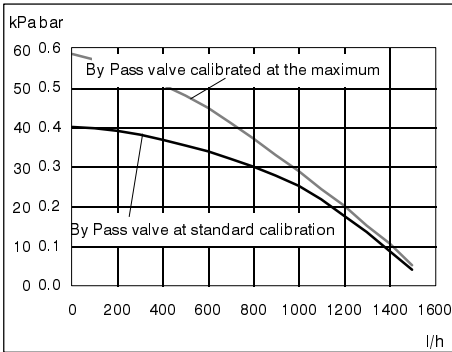

fig. 1.6

The hydraulic specifications in fig. 1.6 represent the available (delivery) pressure of the central heating system as a function of output.

Boiler load loss has already been subtracted.

### Output with thermostat cocks shut off

The boiler is fitted with an automatic by-pass valve (24 on page 3), which protects the primary heat exchanger.

In case of excessive reduction or total blockage of water circulation in the central heating system owing to closure of the thermostatic valves or system component taps, the by-pass valve ensures a minimum flow of water inside the primary heat exchanger.

The by-pass valve is calibrated for a minimal output of 500–600 l/h into the primary heat exchanger.

## 1.10 Expansion tank

The height difference between the pressure relief valve and the highest point in the system may be 7m at most.

For greater differences, increase the pre-load pressure in the expansion tank (28 on page 3) and the system, when cold, by 0.1 bar for each additional 1m.

Total capacity		7,5
Pre-load pressure	kPa	70
	bar	0,7
Available capacity		4,3
Maximum volume of water in the system *		150

tab. 1.1

\* Where conditions are:

- Average maximum temperature of the system is 80°C
- Initial temperature when filling up the system is 10°C

For systems with volumes greater than 150l, an additional expansion tank must be provided.

## 2 GENERAL REQUIREMENTS

This appliance must be installed by a competent person in accordance with the Gas Safety (Installation & Use) Regulations 1984.

### 2.1 Related documents

The installation of this appliance must be in accordance with the relevant requirements of the current Gas Safety (Installation & Use) Regulations, the Local Building Regulations, the current I.E.E. Wiring Regulations, the by-laws of the local water undertaking, and in Scotland, in accordance with the Building Standards (Scotland) Regulation, Health and safety document n° 635 "Electricity at work regs."

It should be in accordance also with the British Standard Codes of Practice:

### 2.2 Location of appliance

The appliance may be installed in any room or internal space, although particular attention is drawn to the requirements of the current I.E.E. Wiring Regulations, and in Scotland, the electrical provisions of the Building Regulations applicable in Scotland, with respect to the installation of the combined appliance in a room containing a bath or shower.

**Where a room – sealed appliance is installed in a room containing a bath or shower, any electrical switch or appliance control, utilising mains electricity should be so situated that it cannot be touched by a person using the bath or shower.**

The location must permit the provision of an adequate flue and termination.

For unusual locations special procedures may be necessary and BS 6798–1987 gives detailed guidance on this aspect.

A compartment used to enclose the appliance must be designed specifically for this purpose.

This appliance is not suitable for external installation.

### 2.3 Flue system

The provision for satisfactory flue termination must be made as described in BS 5440–1.

The appliance must be installed so that the flue terminal is exposed to external air.

It must not be installed so that the terminal discharges into an other room or space as an out-house or lean-to. It is important that the position

of the terminal allows a free passage of air across at all times.

The terminal should be located with due regard for the damage or discoloration that might occur to building products in the vicinity.

In cold and/or humid weather water vapour may condense on leaving the flue terminal; the effect of such "steaming" must be considered.

The minimum acceptable spacing from the terminal to obstructions and ventilation openings are specified in fig. 2.1.

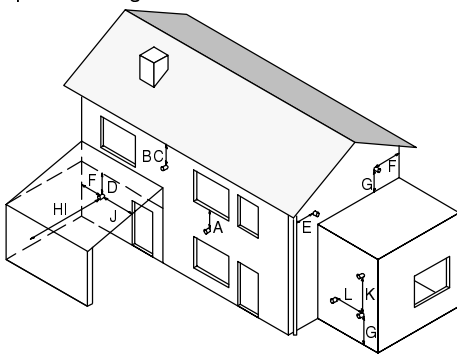

fig. 2.1

Terminal position	mm
A . . . . . Directly below a window or other opening . . . . .	300
B . . . . . Below gutters, solid pipes or drain pipes . . . . .	75
C . . . . . Below eaves . . . . .	200
D . . . . . Below balconies or car port roof . . . . .	650*
E . . . . . From vertical drain pipes and soil pipes . . . . .	75
F . . . . . From internal or external corners . . . . .	450*
G . . . . . Above ground or below balcony level . . . . .	300
H . . . . . From a surface facing a terminal . . . . .	600
I . . . . . From a terminal facing a terminal . . . . .	1 200
J . . . . . From an opening in the car port (e.g. door, window) into dwelling . . . . .	1 200
K . . . . . Vertically from a terminal in the same wall . . . . .	1 500
L . . . . . Horizontally from a terminal in the same wall . . . . .	300

\* specific manufacturer requirements

### 2.4 Gas supply

Gas meter is connected to the service pipe by the local gas region or a local gas region contractor.

If the gas supply for the boiler serves other appliances ensure that an adequate supply is available both to the boiler and the other appliance when they are in use at the same time.

---

## General requirements

---

Pipework must be of adequate size. Pipes of a smaller size than the boiler inlet connection should not be used.

Installation pipes should be fitted in accordance with BS 6891 – 1988 and the complete installation should be tested for soundness.

### **2.5** Air supply

The room in which the boiler is installed does not require a purpose provided air vent.

### **2.6** Ventilation

If installed in a cupboard or compartment, ventilation is also required for cooling.

Recommendations for air supply are detailed in BS 5440 – 2 .

### **2.7** Water circulation (central heating)

Detailed recommendations are given in BS 6798 – 1987 and BS 5449 – 1 1990; the following notes are given for general guidance.

#### **Pipework**

Copper tubing to BS 2871 – 1 1977 is recommended for water pipes. Jointing should be either with capillary soldered or with compression fittings.

Where possible pipes should have a gradient to ensure air is carried naturally to air release points and water flows naturally to drain taps.

The appliance has a built-in automatic air release valve anyway, it should be ensured as far as possible that the appliance heat exchanger is not a natural collecting point for air.

Except where providing useful heat, pipes should be insulated to prevent heat loss and to avoid freezing.

Particular attention should be paid to pipes passing through ventilated spaces in roofs and under floors.

#### **By-pass**

The appliance includes an automatic by-pass valve which protects the main heat exchanger in case of reduced or interrupted water circulation through the heating system due to the closing of thermostatic valves or cock-type valves within the system.

The by-pass is calibrated to assure a minimum flow of 500 – 600 lts/hr through the main heat exchanger.

If you are installing a system that includes thermostatic radiator valves (TRV) and/or small bore (8 – 10 mm) it may be necessary to fit an external by-pass to facilitate correct operations of the boiler.

It may also be necessary to adjust the internal boiler by-pass to the fully open position.

This procedure is explained in the section *By-pass* of the commissioning part of this manual.

#### **Air release points**

These must be fitted at all high points where air will naturally collect and must be sited to facilitate complete fitting of the system.

The appliance has an integral sealed expansion vessel to accommodate the increase of water volume when the system is heated.

It can accept up to 7 lts (1,5 gals.) of expansion water.

If the heating circuit has an unusually high water content, calculate the total expansion and add additional sealed expansion vessel with adequate capacity.

#### **Mains water feed: central heating**

There must be no direct connection to the mains water supply even through a non return valve, without the approval of the Local Water Authority.

#### **Filling**

A method for initially filling the system and replacing water lost during servicing must be provided and it must comply with local water authority regulations.



## General requirements

A possible method is shown in fig. 2.2.

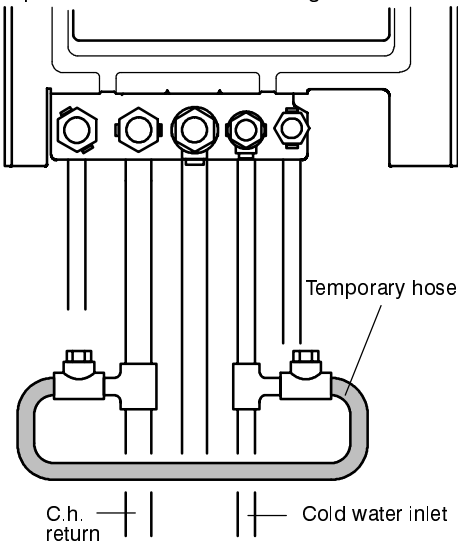

fig. 2.2

The installer should ensure that no leaks exist as frequent filling of the system could cause premature scaling of the heat exchanger.

## 2.8 Domestic water

The domestic water must be in accordance with the relevant recommendations of BS 5546. Copper tubing to BS 2871 – 1 is recommended for water carrying pipework and must be used for pipework carrying potable water.

## 2.9 Electrical supply

**Warning, this appliance must be earthed.**

External wiring to the appliance must be carried out by a competent person and be in accordance with the current I. E. E. Regulations and local regulations which apply.

The boiler is supplied for connection to a 240 V~ 50 Hz supply. The supply must be fused at 3A.

The method of connection to the electricity supply must facilitate complete electrical isolation of the appliance by the use of a fused double pole isolator having a contact separation of at least 3 mm in all poles or alternatively, by the use of a 3A fused three pin plug and unswitched shuttered socket outlet both complying with BS 1363.

The point of connection to the electricity supply must be readily accessible and adjacent to the appliance except where the appliance is installed in a bathroom this must be sited outside the bathroom.

## 3 INSTALLATION

### 3.1 Warnings

The appliance must discharge combustion products directly outside or into a suitable exhaust duct designed for this purpose.

Combustion products must be discharged using Savio flue kits only, since they are integral parts of the boiler.

For LPG, the appliance must also conform with the requirements of the distributors and comply with current Regulations and laws in force.

The safety relief valve must be connected to a suitable drain, in order to prevent flooding if it cuts in.

The electrical wiring must conform with current Regulations, in particular:

- the boiler **must** be earthed using the correct bonding clamp.
- a multi-way switch, with a gap of at least 3 mm between the contacts (fig. 3.1) must be installed near to the boiler. Refer to section 3.6 in this chapter for the electrical connections.

**In no circumstances may the manufacturer be held responsible if the warnings and instructions contained in this manual should not have been complied with.**

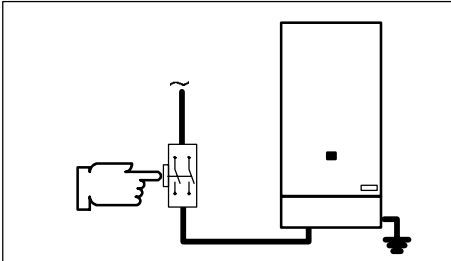

fig. 3.1

### 3.2 Precautions for installation

For the installation proceed as follows:

- The boiler must be attached to a strong wall (fig. 3.2).

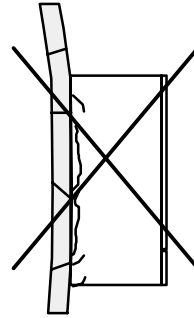

fig. 3.2

- The dimensions for the exhaust fume duct detailed in section 3.5, and the correct procedures for installing the duct, depicted in the instruction leaflet included with the flue kit, must be complied with during installation.
- To allow maintenance procedures it is necessary to leave the minimum gaps indicated in fig. 3.3.

$$\text{I} \quad \left| \begin{array}{l} a=400, b=50 \\ c=300, d=50 \end{array} \right.$$

Or:

$$\text{II} \quad \left| \begin{array}{l} a=200, b=50 \\ c=600, d=50 \end{array} \right.$$

Or:

$$\text{III} \quad \left| \begin{array}{l} a=200, b=130 \\ c=300, d=50 \end{array} \right.$$

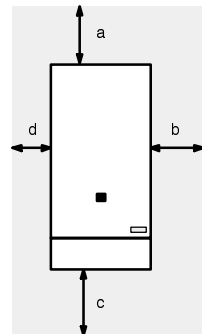

All dimensions in mm

fig. 3.3

- When installing the boiler in a cupboard, cover or in an alcove, further than the distances defined in fig. 3.3, bear in mind that any possible obstacle in front of the boiler (the cupboard door for example) must be at least 10 cm away from it.
- If the boiler is installed outside, cover the appliance to protect it against the elements and add some special anti-freeze (neutralised) to

## Installation

the central heating system.

An optional anti-freeze kit is available to be fitted with this appliance.

- Where there is an existing central heating system, flush it out thoroughly before fitting the boiler, so as to remove muddy deposits developed over time.
- It is advisable to equip the system with a sediment filter, or use a water-treatment product in the circulating water.  
The latter option in particular, not only cleans out the system, but also has an anti-corrosive effect by promoting formation of a protective skin on metal surfaces and neutralising gases present in the water.  
We recommend the use of a suitable universal inhibitor to protect the central heating system from corrosion.

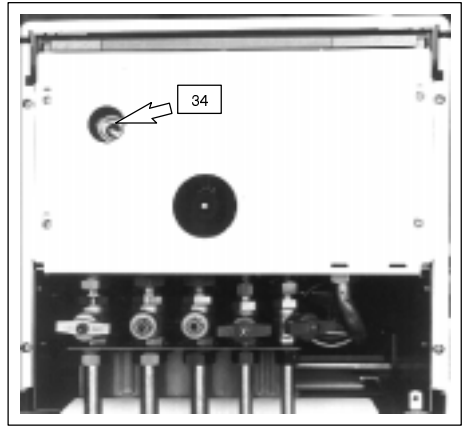

fig. 3.4

### 3.3 Installing the template

Dimensions and useful data for fitting the boiler are detailed in sections 3.7 and 3.8 of this chapter. Refer to the instruction leaflet included with the template kit, packed separately.

#### Precautions

Before mounting the template, check that the dimensions for fitting the exhaust fume duct are complied with (refer to the leaflet included with the flue kit, packed separately).

After mounting the template and before mounting the boiler, make sure the gas supply system is not leaking.

### 3.4 Mounting the boiler

- 1 Take the protective caps off the boiler pipework.
- 2 Thoroughly clean the taps fixed on the template.
- 3 Mount the boiler on its brackets.
- 4 Connect the pipework using the original seals supplied with the taps. You are recommended to tighten up the water and gas joints well.
- 5 Connect the pressure relief valve's outlet to a drain (34 in fig. 3.4).

### 3.5 Fitting the exhaust fume duct

Refer to the leaflet included in the chosen kit, packed separately.

The following kits for connecting the boiler to the flue are available:

- 1 Exhaust fumes from wall and possible co-axial extensions  $\varnothing$  60/100 mm
- 2 Vertical outlet  $\varnothing$  60/100 mm
- 3 Connection for co-axial flue  $\varnothing$  60/100 mm
- 4 Additional co-axial 90° or 45° elbow  $\varnothing$  60/100 mm
- 5 Twin split pipes kit and possible extensions  $\varnothing$  80 mm
- 6 Additional 90° elbow  $\varnothing$  80 mm
- 7 Roof duct and possible extensions  $\varnothing$  mm

Kit 1 allows the flue to be fitted on any side of the boiler and it can be **shortened to a minimum** of 0.55 m. Use of extensions allows the exhaust fume duct to be lengthened.

For model **124** the **greatest total length** is 1.85 m, while the **greatest total length** is 3 m for model **120**.

Kit 2 is an accessory that allows use of a section of vertical ducting from the boiler.

## Installation

In fitting, only one type kit 2 can be used.

Kit 3 is an accessory that allows the fumes to be discharged through co-axial flues.

Each additional 90° elbow  $\varnothing$  60/100 mm reduces the greatest length of the fume duct by 1 m, whilst those of 45° reduce it by 0.5 m.

Kit 5 is an accessory that allows separation of the air supply pipe from the pipe that discharges fumes in the flue.

Kit 6 is an accessory that allows changing the direction of the pipes of kit 5.

Each additional 90° elbow  $\varnothing$  80 mm reduces the maximum length of the duct by 1 m.

Kit 7 allows venting of fumes directly to the roof. The greatest total height is 5 m.

### 3.6 Electrical connections

#### Connection to the electricity supply

- 1 Connect the electrical supply cable coming from the multi-way switch to the supply connector for the boiler (fig. 3.5) keeping the same connections for the live (brown wire) and the neutral (blue wire).

External 3 A fuse or fused plug with same current rating is recommended.

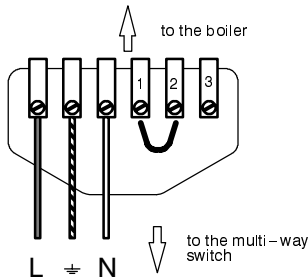

fig. 3.5

#### 2 Connect the earth wire (yellow/green).

The cable or wire for the appliance's electricity supply must be of not less than 0.75 mm<sup>2</sup> gauge but must adhere to the current Regulations.

#### Connection of a room thermostat

To connect a room thermostat to the boiler, use the same connector as the electricity supply terminal block (fig. 3.6 and fig. 3.7).

**When connecting any type of room thermostat, the jumper present between 1 and 2 must be removed.**

**Take care not to connect live wires to terminals 1 and 2.**

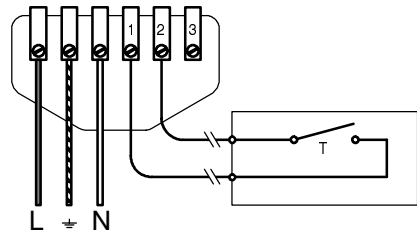

fig. 3.6 Two-wire thermostat. (240 V only).

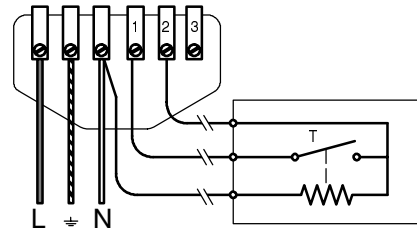

fig. 3.7 Two-wire thermostat with delay resistor

## Installation

### 3.7 Dimensions

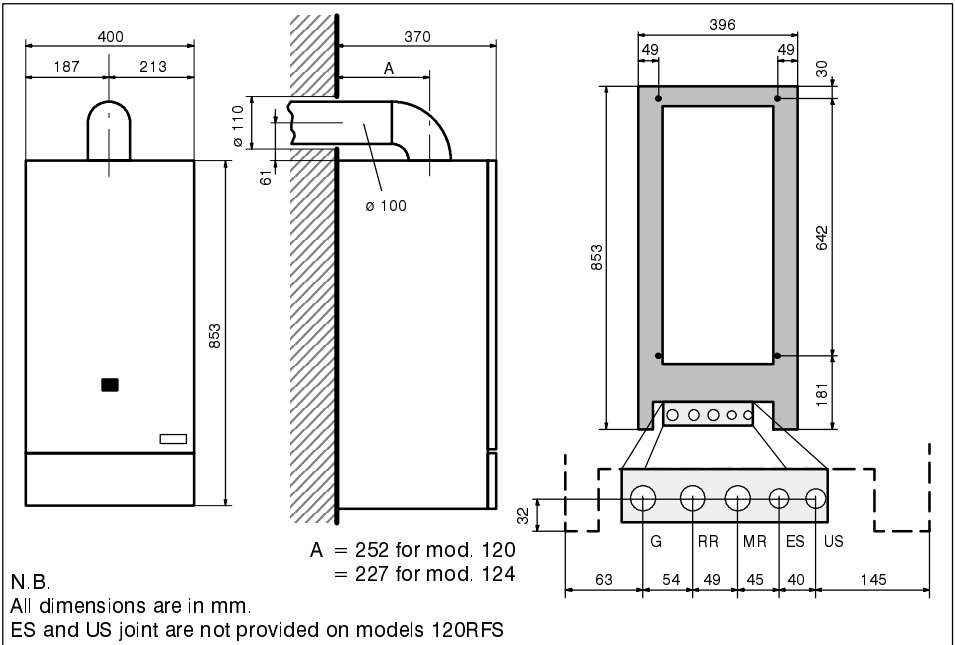

fig. 3.8

### 3.8 Joints

Initials	Function	Tap thread	Elbow	Threaded joint (optional)
G	Gas	G 3/4 M	ø 22 o.d.	G 3/4 M
RR	Central heating return	G 3/4 M	ø 22 o.d.	G 3/4 M
MR	Central heating flow	G 3/4 M	ø 22 o.d.	G 3/4 M
ES	Cold water in	G 1/2 M	ø 15 o.d.	G 1/2 M
US	Domestic hot water out	G 1/2 M	ø 15 o.d.	G 1/2 M
3 bar pressure relief valve joint				G 1/2 F
<p>Nota: the letters "M" and "F" denote a male or female socket system attachment. "ES" and "US" joint is not provided on <b>Central heating only</b> boilers.</p>				

tab. 3.1

## 4 COMMISSIONING

### 4.1 Electrical installation

Preliminary electrical system checks to ensure electrical safety shall be carried out by a competent person. i.e. polarity, earth continuity, resistance to earth and short circuit.

If a fault has occurred on appliance the fault finding procedure should be followed as specified under the servicing section of this document.

### 4.2 Gas supply installation

Inspect the entire installation including the gas meter, test for soundness and purge, all as described in BS 6891;

Open the gas cock (shown in fig. 4.1 with the knob in "open" position) on the appliance and check the gas connector on the appliance for leaks.

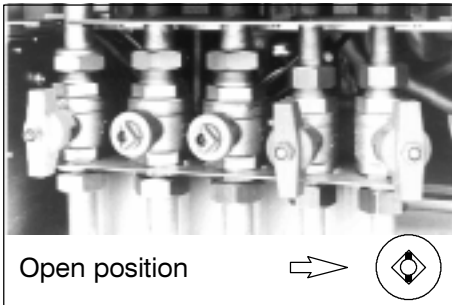

fig. 4.1

### 4.3 Filling the D.H.W. system

Close all hot water draw-off taps.

Open the cold water inlet cock.

Slowly open each draw-off tap and close it only when clear water, free of bubbles, flows out.

### 4.4 Initial filling of the system

Open central heating flow and return cocks.

Remove the front panel of the case, the lower protection plate and lower the control panel (see the section *Access to and emptying the hydraulic circuits* in the service manual).

Unscrew the cap on the automatic air release valve (fig. 4.2) one full turn and leave open permanently;

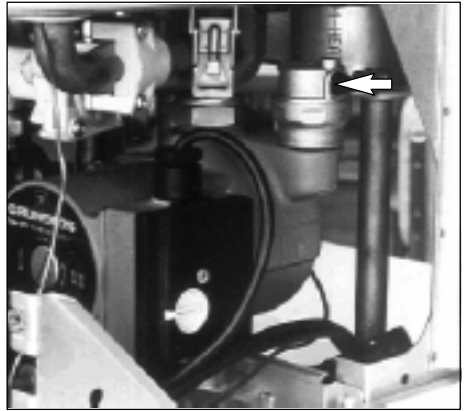

fig. 4.2

On the combination boilers unscrew the manual bleed valve fitted to the primary water pipe of the secondary heat exchanger (fig. 4.3).

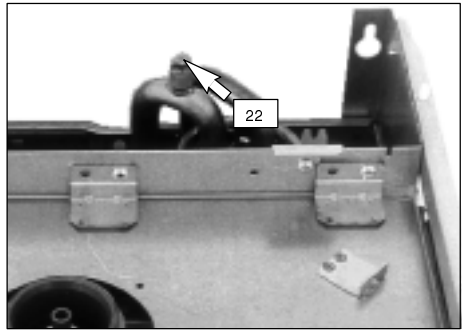

fig. 4.3

Gradually open stopcock at the filling point connection to the central heating system until water is heard to flow; do not open fully.

Open each air release tap starting with the lower point and close it only when clear water, free of bubbles, flows out;

Purge the air from the pump by unscrewing the pump plug indicated (fig. 4.4); release the pump

## Commissioning

by turning the rotor in the direction indicated by the arrow on the information plate;

close the pump plug;

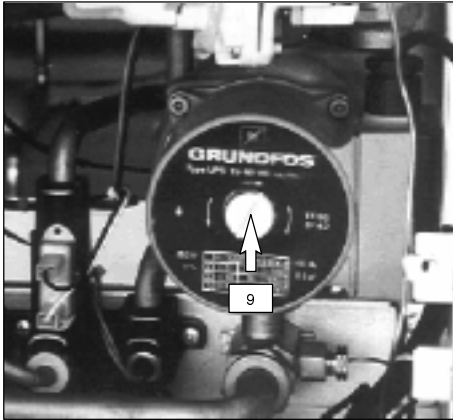

fig. 4.4

continue filling the system. The actual reading should ideally be 1 bar and not less than 0,3 bar. Close all air release valves on central heating system.

inspect the system for water soundness and remedy any leaks discovered.

**When the installation and filling are completed turn on the central heating system and run it until the temperature has reached the boiler operating temperature. The system must then be immediately flushed through.**

**The flushing procedure must be in line with BS7593: 1992 *Treatment of Water in Domestic Hot Water Central Heating Systems*.**

**This procedure must be repeated twice more.**

During this operation we highly recommend the use of a central heating flushing detergent in the quantities as specified by the appropriate manufacturer, whose function it is to dissolve any foreign matter which may be in the system

The above operation could save the invalidation of your boilers guarantee and will also pre-

**vent problems which you may experience in the future if an inhibitor is not used.**

### 4.5 Lighting the boiler

If external controls are fitted (e. g. Timeclock, room thermostat) ensure they "call for heat".

Switch on the mains electricity and turn the function switch as indicated in fig. 4.5 (combined boilers) or fig. 4.6 (central heating only boilers).

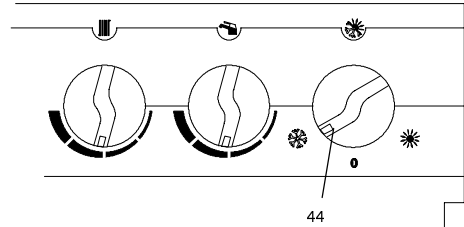

fig. 4.5

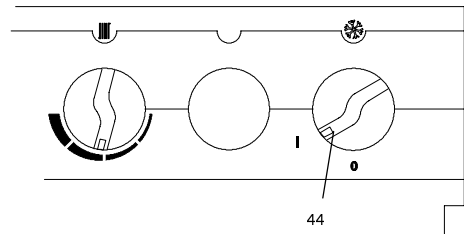

fig. 4.6

The boiler will now go through an ignition sequence and the burner will light.

If during the ignition attempt period the boiler fails to light, the full sequence control p.c.b. will go to lockout and the shut-down warning light will appear.

To reset the boiler depress the reset push button.

### 4.6 Checking the gas pressure at the burner

This boiler has been tested to the highest quality controls standards.

The maximum and minimum gas pressures are already pre-set during this quality control process.

It is therefore not normally necessary to undertake further adjustments however, a full explanation of pressure testing procedure is given below and the adjustment procedure is given in the service manual, *Gas Valve* section, if these operations are ever required.

Remove the front panel of the case and lower the control panel.

Remove the screw A (fig. 4.7) on the pressure test point for measuring outlet pressure at the gas valve and fit a pressure gauge using a hose;



fig. 4.7

Switch on the boiler.

On the combined boilers open the hot water tap fully.

Set the d.h.w. temperature adjustment and the c.h. temperature adjustment to their maximum position.

Check the maximum gas pressure and compare the value on the manometer with the values indicated on the section *General – Technical data*

Check the maximum gas flow at the gas meter and compare with the values indicated on the section *General – Technical data*

turn off the electricity supply;

disconnect the gas modulator removing the connector B (fig. 4.7).

Switch on the boiler.

check the minimum gas pressure and compare the value on the manometer with the values indicated on the section *General – Technical data*

switch off the appliance and re-connect the line to the gas modulator;

close the domestic hot water cock.

### 4.7 Checking the flue system

The flue system should be visually checked for soundness. Check all clamps, gaskets and fixings are secure and tight.

To check the exhaust gas, remove the screw indicated and connect the analyzer to the exhaust gas sampling point (fig. 4.8).

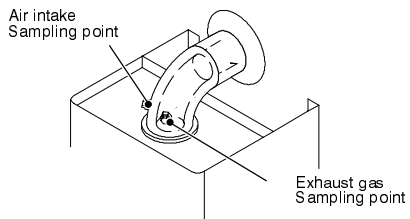

fig. 4.8

### 4.8 Checking the ignition device

With the burner on high flame close the gas cock. about 10 seconds after, the shut-down warning light must appear.

To reset the boiler depress the reset push button marked with the symbol:



### 4.9 Selecting the circulator modes

When the boiler heats, three operating modes can be selected in the pump through a jumper connection on the electronic control circuit.

To adjust the jumper proceed as follows:

Turn off the electricity supply to the boiler using the multi-way switch provided with the appliance;

Insert a small flat-bladed screwdriver into the two slots indicated in fig. 4.9.

Lever upwards **gently** with the screwdriver so as to unfasten panel "A" by rotating it downwards.

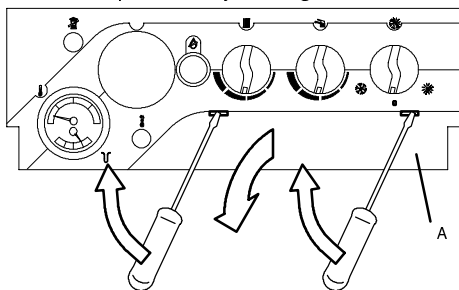

fig. 4.9

Reposition the jumper for the pump for the function required (fig. 4.10).

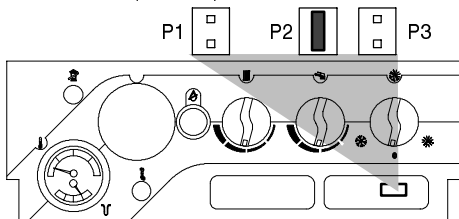

fig. 4.10

With the jumper on terminals P1 the pump is on only when output is demanded, that is when the main burner is lit.

With the jumper on terminals P2 the pump is on, controlled by the room thermostat.

With the jumper on terminals P3 the pump is always on.

Whatever the mode chosen, in all cases the pump is automatically started during delivery of domestic hot water, both when the boiler is set up for cen-

tral heating/domestic hot water operation and for domestic hot water only.

**The jumper must never be removed.**

### 4.10 Adjusting the burner ignition

- 1 Turn off the boiler by means of the multi-way switch provided with the appliance.
- 2 Make sure that the function switch (44) is set to the position in fig. 4.11 or fig. 4.12 and that the room thermostat, if fitted, is set to "heat demand".

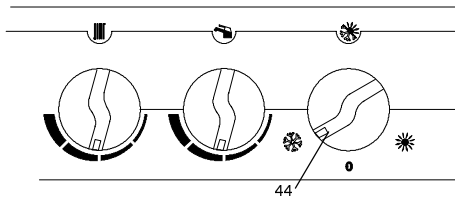

fig. 4.11

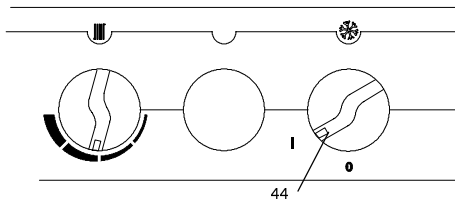

fig. 4.12

- 3 Unscrew the gas valve's outlet pressure tap (A in fig. 4.7) and connect a pressure gauge.
- 4 Insert a small flat-bladed screwdriver into the two slots indicated in fig. 4.9. Lever upwards **gently** with the screwdriver so as to unfasten panel "A" by rotating it downwards.
- 5 Turn on the boiler.
- 6 Check that the boiler lights up uniformly and adjust the flame height, if necessary. To adjust the ignition, set dip-switch "3" (fig. 4.13) to the OFF position and adjust potentiometer marked "ACC" with a screwdriver until correct lighting up is obtained (refer to tab. 4.1). Having finished this procedure, reset dip-switch "3" to the ON position.

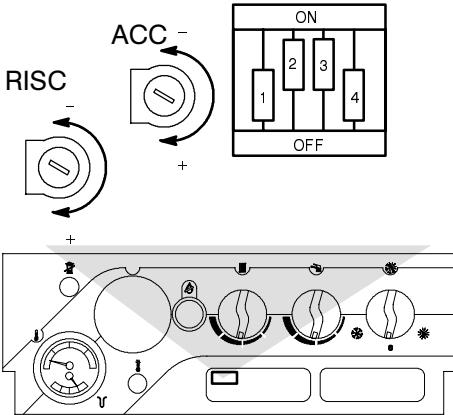

fig. 4.13

Ignition pressure			
		120MFS 120RFS	124MFS
Natural G20	Pa	400	400
	mbar	4,0	4,0
Butane G30	Pa	480	510
	mbar	4,8	5,1
Propane G31	Pa	700	670
	mbar	7,0	6,7

tab. 4.1

### 4.11 Adjustment of useful central heating output

Use a suitable screwdriver to turn the adjustment potentiometer marked “RISC” (fig. 4.13). Rotating the potentiometer anti-clockwise reduces the maximum supply current to the gas modulator device.

Set the gas pressure according to the useful output chosen and adjust the gas flow rate according to fig. 4.14, fig. 4.15, and fig. 4.16.

Shut the lower cover of the control circuit board.

**Close the pressure taps well** and re-mount the case properly.

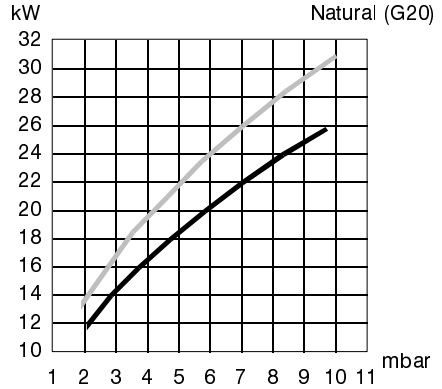

fig. 4.14

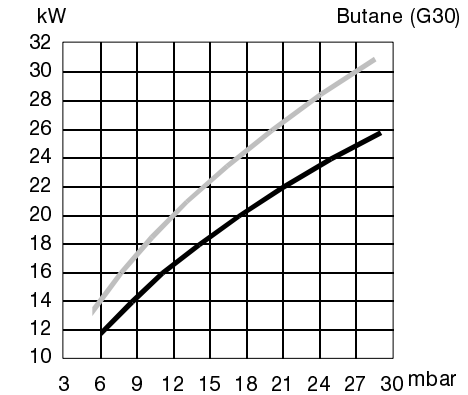

fig. 4.15

---

## Commissioning

---

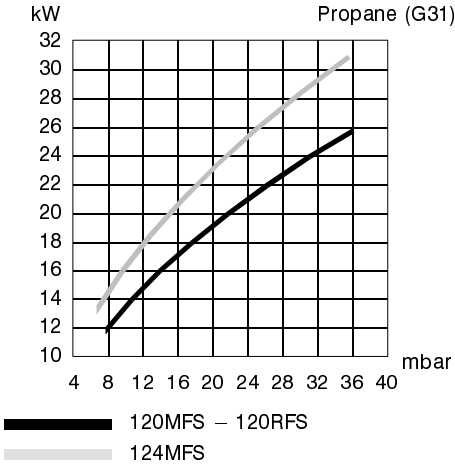

fig. 4.16

### 4.12 Instructing the user

Hand over the *User's instructions* supplied with the appliance and explain how to use the unit in both c.h. and d.h.w. modes;

take the User step by step through the lighting instructions;

show the User how to switch off the appliance quickly and indicate the position of the electric supply isolator;

explain the proper use and adjustment of all system controls; this will ensure the greatest possible fuel economy;

explain the function and use of the function switch;

explain and demonstrate the function of time and temperature controls (if fitted);

explain how to turn off the appliance for both short and long periods and advise on the precautions necessary to prevent damage should the appliance be inoperative when freezing conditions may occur;

finally, advise the User that, for continued safe and efficient operation, the appliance must be serviced by a competent person at least once a year.

## 5 GAS CONVERSION

### 5.1 Warnings

Procedures to adapt the boiler to the type of gas available **must be carried out** by a competent and responsible person.

Components used to adapt it to the type of gas available must be genuine parts only.

More detailed instructions, relating to the procedures for adapting the boiler to the type of gas available and subsequent calibration described below, are presented in the instruction leaflet for the conversion kit.

### 5.2 Procedures

- 1 Check that the gas cock (29 on page 3) fitted under the boiler is turned off and the appliance is not live.
- 2 Take off the front and right-hand side panels as shown in chapter *maintenance*, section 6.2 of this manual.
- 3 Take off the removable side of the air-tight chamber.
- 4 Undo the two screws "A" indicated fig. 5.1 and turn over the control panel towards you.

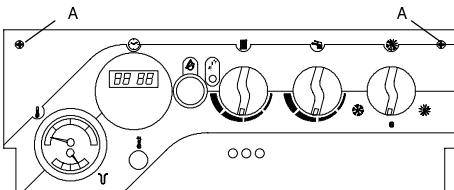

fig. 5.1

- 5 Take the front panel of the combustion chamber off and remove the burner (19 on page 3).
- 6 Carry out the conversion for the type of gas, replacing the burner injectors (19 on page 3) correctly.
- 7 Re-assemble the burner (19 on page 3), the front panel of the combustion chamber and the removable side of the air-tight chamber.
- 8 Insert a small flat-bladed screwdriver into the two slots indicated in fig. 5.2. Lever upwards **gently** with the screwdriver so as to unfasten panel "A" by rotating it downwards.

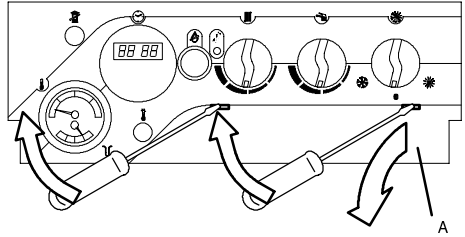

fig. 5.2

- 9 set correctly the dip-switch "2" (fig. 5.3) in accordance with the following table referring to the colour of the gas modulating cartridge.

Gas modulating cartridge colour (on the gas valve)	Gas supply	Position of dip-switch n. 2
White	Natural gas	Off
Black	L.P.G.	Off
Red	Natural gas	On
	L.P.G.	Off

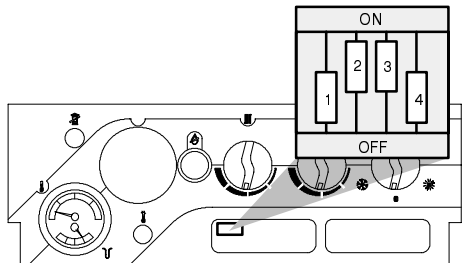

fig. 5.3

- 10 Calibrate the gas valve according to the instructions given in the leaflet included with the conversion kit.
- 11 Fix the control panel in its original position. Replace the the control circuit board cover, the front panel and the right-hand side panel of the case.
- 12 Stick a label indicating the type of gas, and the pressure level to which the appliance has been set, on the front panel of the case. The self-adhesive label is included with the conversion kit.

## 6 MAINTENANCE

### 6.1 Warnings

The procedures detailed in this chapter **must be carried out only by a professionally qualified person**. Thus you are advised to contact an Authorised Service Centre.

For efficient and continuous operation of the boiler you are advised to have, at least once a year, maintenance and cleaning done by an Authorised Service Centre engineer.

**Isolate the appliance from the electricity supply** by turning off the multi-way switch fitted with the appliance and **turn off the gas cock**, before carrying out any procedures, whatsoever, for cleaning, maintenance, opening or dismantling boiler panels.

### 6.2 Dismantling the external panels

#### Front panel

- 1 Open the front panel and undo the two screws "A". Take off the front panel "B" by moving it up so as to free it from the hooks above (fig. 6.1)

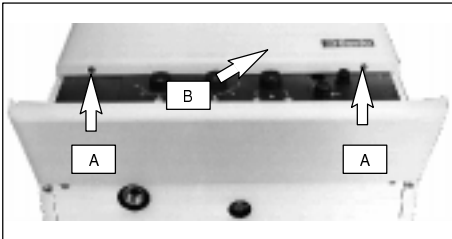

fig. 6.1

#### Side panels

- 2 Slacken off screws "A" (fig. 6.2) and remove the two side panels.

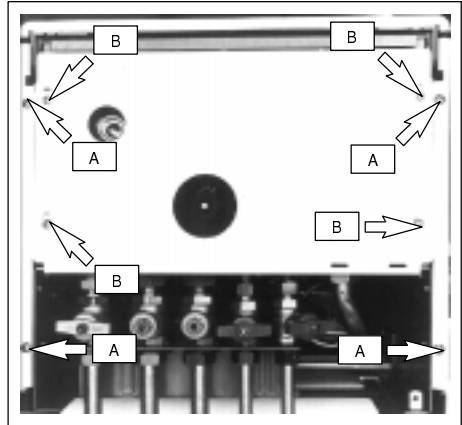

fig. 6.2

#### Lower protection plate

- 3 Slacken off screws "B" (fig. 6.2) and remove the lower protection plate moving it towards the back side of the boiler.

### 6.3 Emptying the domestic hot water system (Combination boilers only)

- 1 Turn off the cold water in (32) and domestic hot water out (33) cocks in fig. 6.3

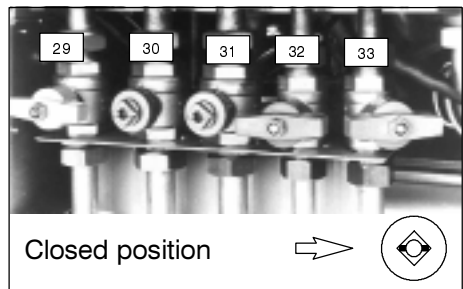

fig. 6.3

- 2 Loosen the domestic hot water circuit drain cocks (36 in fig. 6.4).

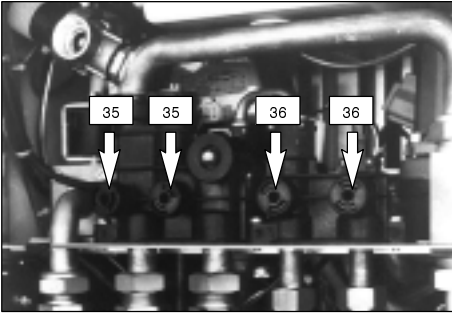

fig. 6.4

### 6.4 Emptying the central heating system

- 1 Turn off the central heating system flow (31) and return (30) cocks (fig. 6.3).
- 2 Loosen the boiler drain cocks (35 in fig. 6.4).
- 3 To empty **Combination** boilers more easily, slacken off the manual bleed valve fitted to the primary water pipe of the domestic hot water heat exchanger (22 in fig. 6.5).
- 4 To empty **Central heating** boilers more easily, remove the front panel, the right panel of the case and the sealed chamber cover (section 6.2 in this chapter); slacken off the manual bleed valve fitted to the primary water pipe of the main heat exchanger (fig. 6.6).

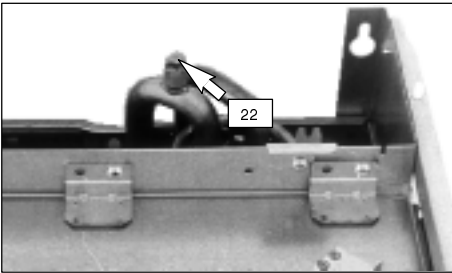

fig. 6.5

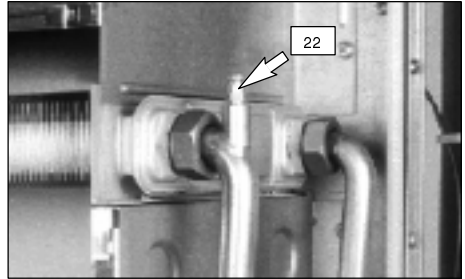

fig. 6.6

### 6.5 Cleaning the primary heat exchanger

Take off the front and right-hand side panels of the case, then the removable side of the air-tight chamber and the front panel of the combustion chamber.

If you notice dirt on the fins of the primary heat exchanger (21 on page 3), cover the sloping surfaces of the burner (19 on page 3) entirely in a protective layer (sheets of newspaper or similar). Brush out the primary heat exchanger (21 on page 3) with a bristle paintbrush.

### 6.6 Checking the pressurisation in the expansion tank

Empty the central heating system as described in section 6.4 of this chapter and check that the pressure in the expansion tank is not less than 0.7 bar.

If the pressure should be lower, take steps to correct the pressure level.

### 6.7 Cleaning the burner

The sloping and multi-gas type burner (19 on page 3) does not need special maintenance, but it is sufficient to dust it with a bristle paintbrush.

### 6.8 Checking the exhaust duct

Have the integrity of the exhaust fume duct (37 on page 3) air duct (38 on page 3), checked periodically, the venturi (2 on page 3) cleaned and the efficiency of the exhaust safety circuit checked at least once a year.





17962.0485.0 9610

**BIASI U.K Ltd**  
Unit 32/33, Planetary Road  
Industrial Estate, Neachelles Lane  
Willenhall, Wolverhampton WV13 3XB