

BAXI

User's Operating Instructions &
Important Warranty Information

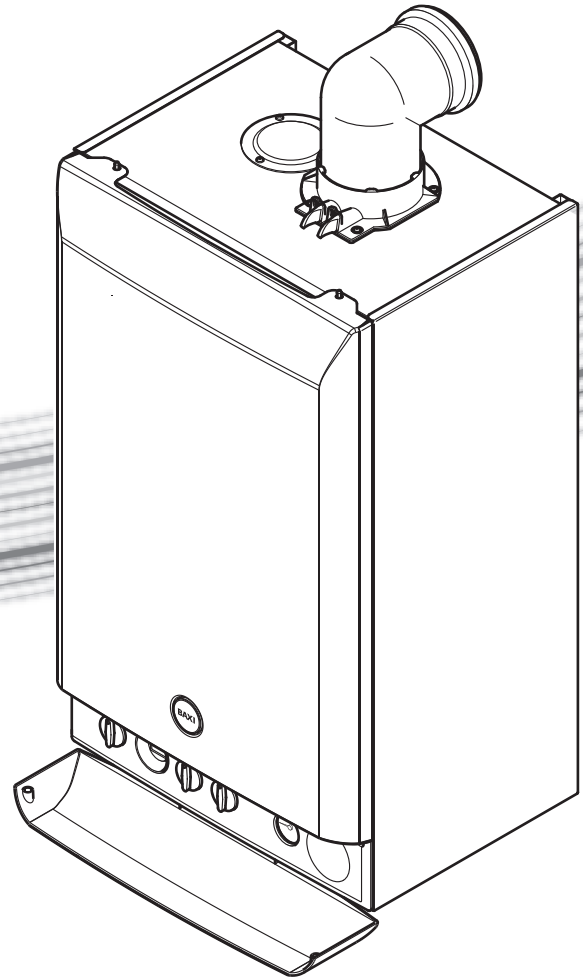

Baxi Megaflo System HE IE Range

Gas Fired Wall Mounted Condensing Boiler

Please keep these instructions in a safe place.
If you move house, please hand them over to the next occupier.

Section	Page
1.0 Quick Reference Guide	3
2.0 Troubleshooting	4
3.0 Repressurising System	6
4.0 Clearances	7
5.0 Care of the Boiler	8
6.0 Legislation	9
7.0 Notes	10
8.0 Emergency	11
9.0 Warranty & Service	12

Natural Gas

Baxi Megaflo System 15 HE IE

Baxi Megaflo System 18 HE IE

Baxi Megaflo System 24 HE IE

Baxi Megaflo System 28 HE IE

Baxi Megaflo System 32 HE IE

Propane Gas

Baxi Megaflo System 24 HE IE LPG

Baxi Megaflo System 28 HE IE LPG

© Baxi Heating UK Ltd 2011 All rights reserved. No part of this publication may be reproduced or transmitted in any form or by any means, or stored in any retrieval system of any nature (including in any database), in each case whether electronic, mechanical, recording or otherwise, without the prior written permission of the copyright owner, except for permitted fair dealing under Copyrights, Designs and Patents Act 1988.

Applications for the copyright owner's permission to reproduce or make other use of any part of this publication should be made, giving details of the proposed use, to the following address:

The Company Secretary, Baxi Heating UK Ltd,
Brooks House, Coventry Road, Warwick. CV34 4LL

Full acknowledgement of author and source must be given.

WARNING: Any person who does any unauthorised act in relation to a copyright work may be liable to criminal prosecution and civil claims for damages.

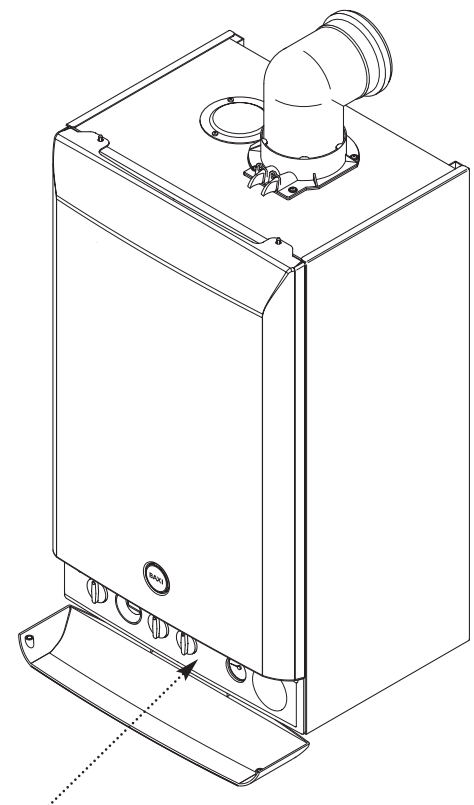

Boiler Controls - see opposite page for Operating Quick Reference Guide



ISO 9001
FM 00866

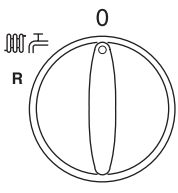

ON/OFF/Reset Selector Switch

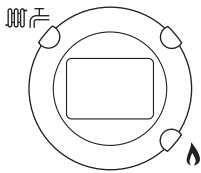

Display

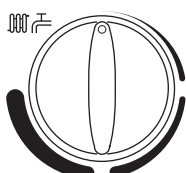

Central Heating Temperature Control

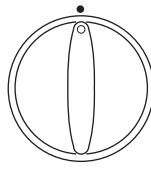

Calibration Control

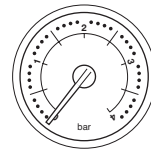

System Pressure Gauge

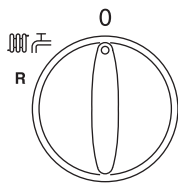
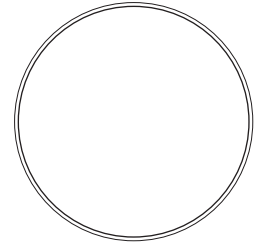

OFF Position

The boiler will not operate.

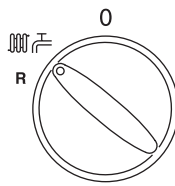

Central Heating & Hot Water

Both Heating & Hot Water will operate.

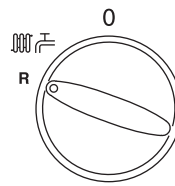

Reset

Hold for approx 5 seconds and release.

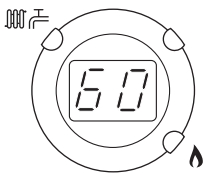

Display



Central Heating & Hot Water Indicator - The indicator will illuminate when the boiler is in the central heating/hot water mode.



Burner On Indicator - The indicator will illuminate when the burner has fired and is heating your central heating or domestic hot water.

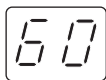

Boiler Output Temperature - In either the central heating or domestic hot water position the display will illuminate showing the current boiler temperature in degrees centigrade.

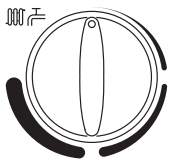

Central Heating Temperature Control

Turn the knob clockwise to increase or anticlockwise to decrease the temperature. Range 25 - 80° C.

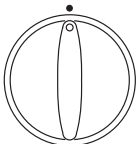

Calibration Control

This control is for use only by the installer or service engineer.



Central Heating System Pressure - The normal operating water pressure is at least 0.2 bar. If the pressure exceeds 3 bar the safety pressure valve will operate and a fault is indicated. Contact your Installer.

Boiler not working

2.0 Troubleshooting

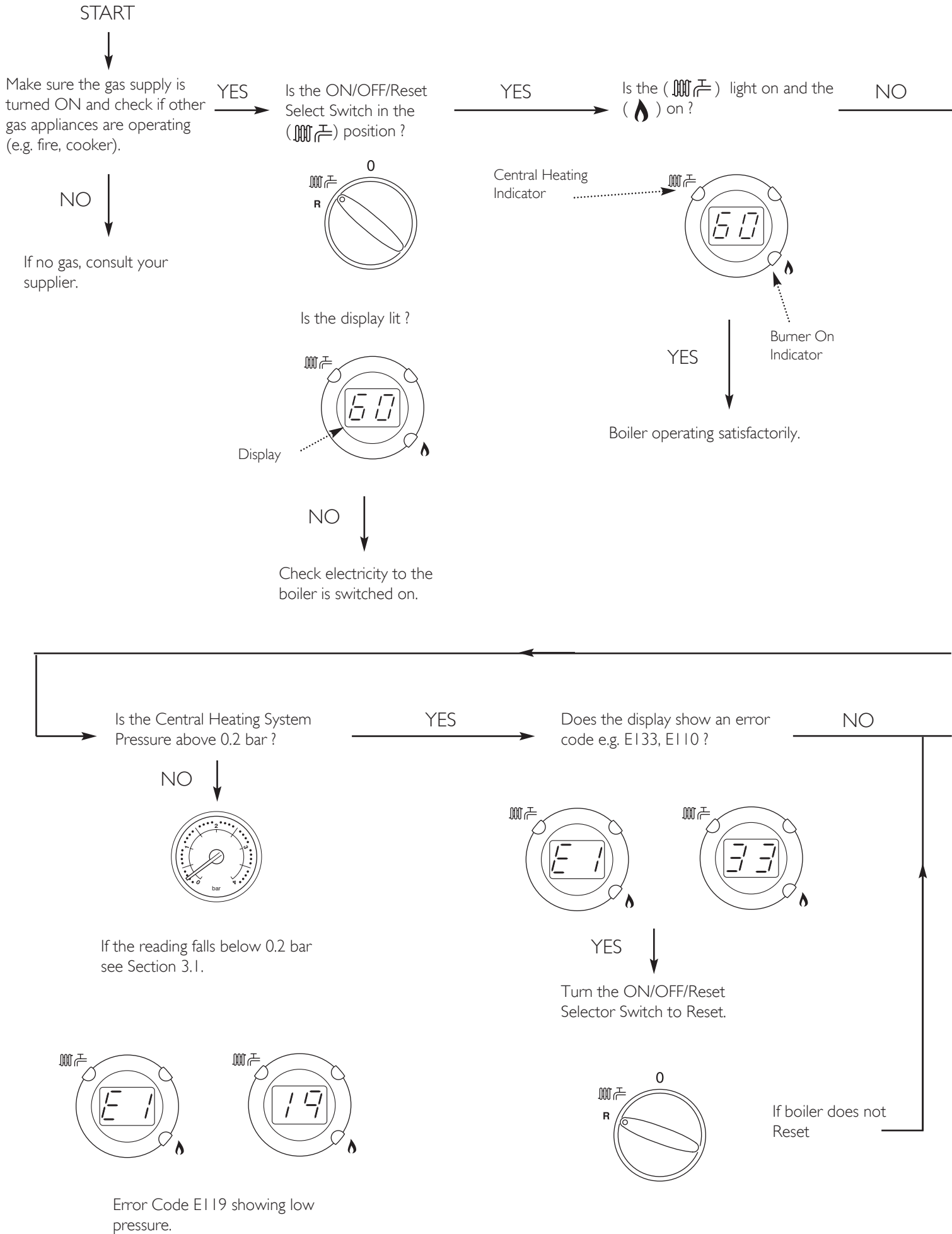

Is the Timer ON and calling for heat ?

YES

Is the Room Thermostat (if fitted) set high enough ?

YES

Typical examples of external timer

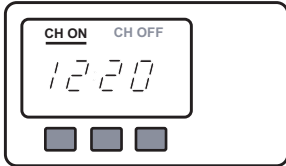
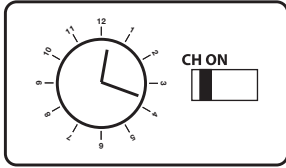

NO

Ensure timer is set for Central Heating ON (see any instructions supplied with timer).

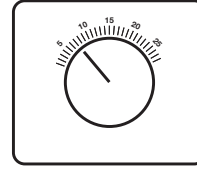

NO

Turn Room Thermostat to maximum setting (typical example shown).

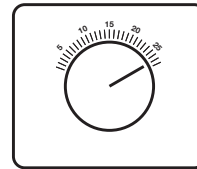

CONTACT YOUR INSTALLER OR SERVICE ENGINEER.

If you don't know what you need to do to get the boiler to light, or need help with the system and controls, contact your installer as soon as possible.

3.0 System Pressure

3.1 Central Heating System Pressure

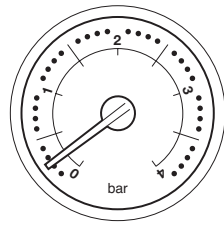

Fig. 1

Normal MINIMUM Pressure

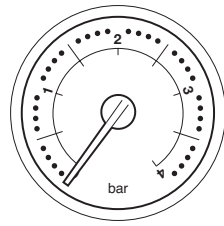

Fig. 2

Requires
Repressurising

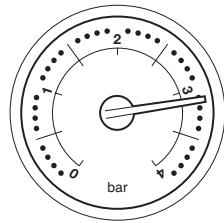

Fig. 3

Fault

1. The boiler may be installed in two types of heating system, 'sealed' or 'semi - sealed'. Your installer will be able to advise you of the type of system and explain the operation.

2. The 'sealed' type is pressurised from the mains by means of a device called the filling loop, which may also be used to re-pressurise the system.

3. The 'semi - sealed' type relies on a header tank of water to fill the system through a non - return valve. This type of system should automatically maintain suitable pressure.

4. The normal operating water pressure must be at least 0.2 bar (Fig. 1) for the boiler to operate. If the pressure exceeds 3 bar (Fig. 3) the safety pressure valve will operate and a fault is indicated. Contact your installer.

'Sealed' Systems Only

5. It may be necessary to repressurise the system occasionally (Fig. 2). A filling device (the filling loop) will be fitted on the system.

6. If you are unsure of its position, or cannot identify it, consult the installer who fitted the boiler.

7. The filling loop consists of two taps and a separate metal braided hose with connection fittings.

8. Only when repressurising should the hose be connected between the two taps. Ensure that the nuts on the pipe ends are tightened onto the taps.

9. Fully open one of the taps first, and then while watching the pressure gauge, carefully open the second tap.

10. When the needle on the gauge is indicating 0.2 or more turn both taps off.

11. Disconnect the metal braided hose from the taps (a small amount of water may be present) and remove it. Keep the hose in a safe place for future use.

'Semi - Sealed' Systems Only

12. The header tank on the 'semi - sealed' system should maintain the pressure at a minimum of 0.2 bar. If the pressure drops below this consult your installer.

4.0 Clearances

4.1 For your Safety

1. This appliance must have been installed in accordance with the manufacturer's instructions and the regulations in force.

2. Any modification that may interfere with the normal operation of the appliance without express written permission from the manufacturer or his agent could invalidate the appliance warranty.

3. Your boiler must not be operated without the casing correctly fitted.

4. Do not interfere with any sealed components on this boiler.

5. Take note of any warning labels on your boiler.

6. Your boiler should have the following minimum clearances for Safety and Maintenance (Figs. 4 & 5):-

Top	- 200mm
Bottom	- 150mm
Left side	- 5mm
Right Side	- 5mm
Front	- 5mm (In Operation)
	- 450mm (For Servicing)

*This is the MINIMUM recommended dimension. Greater clearance than this will aid installation and maintenance.

7. If your boiler is installed in a compartment, do not use it for storage purposes. Do not obstruct any purpose provided ventilation openings.

8. Flammable materials must not be stored in close proximity to your boiler.

9. Avoid skin contact when your boiler is in operation, as some surfaces may get hot e.g. pipework.

10. Ensure that the flue terminal, outside the house, does not become damaged or obstructed, particularly by foliage.

11. It is important that the condensate drain system is not blocked, modified or damaged in any way as this would affect the operation of your boiler. Your installer should have insulated any exposed pipework.

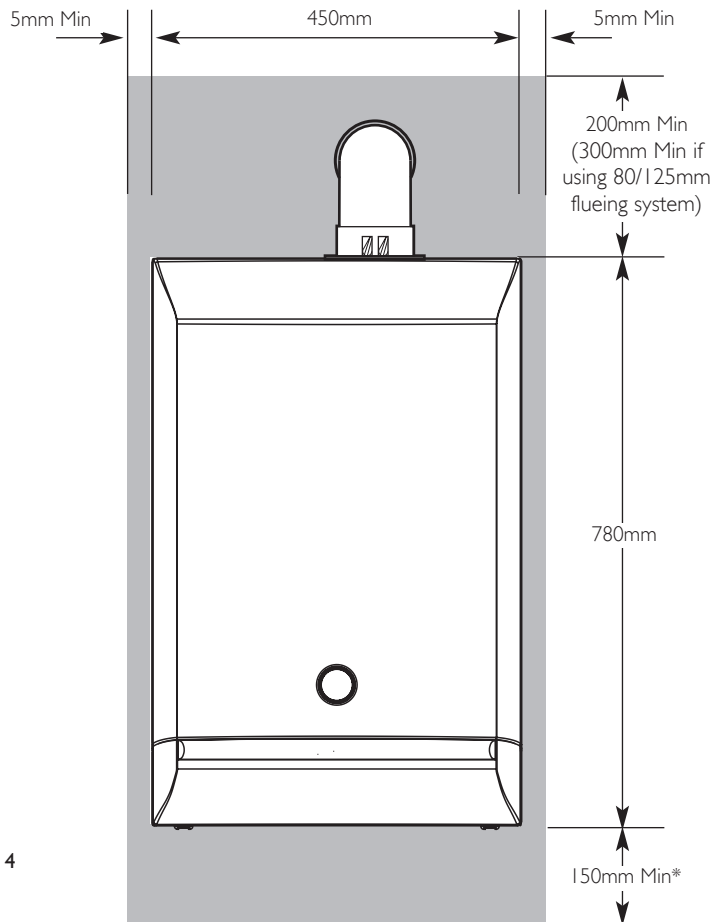

Fig. 4

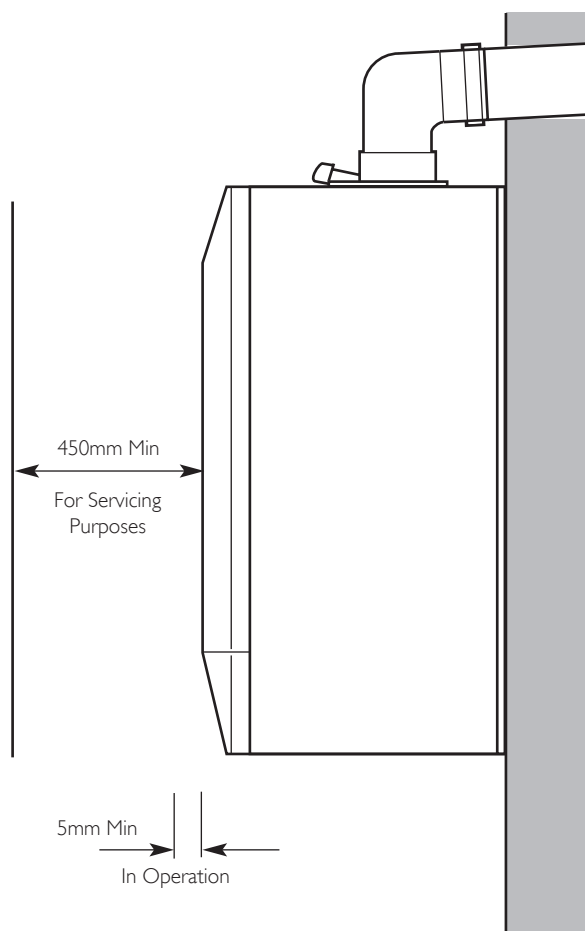



Fig. 5

5.0 Care of the Boiler

5.1 Cleaning the Outer case

1. The painted panels should be wiped with a damp cloth and then dried completely. **DO NOT USE ABRASIVE CLEANING AGENTS.**

5.2 Protection & Precaution

1. The boiler incorporates an integral frost protection feature that will operate when the selector switch is in () position. If the boiler temperature falls below 5° C, then the boiler will operate until the water temperature has been raised.

2. If a system frost thermostat has been fitted (your installer will be able to advise you), then to operate correctly and protect your system, the gas and electricity must be left on and the appliance set in the central heating mode.

3. The boiler incorporates an integral pump protection feature which continually monitors the time since the pump last operated. To prevent seizure, the pump will operate for approximately 1 minute if it has not run in the last 24 hours.

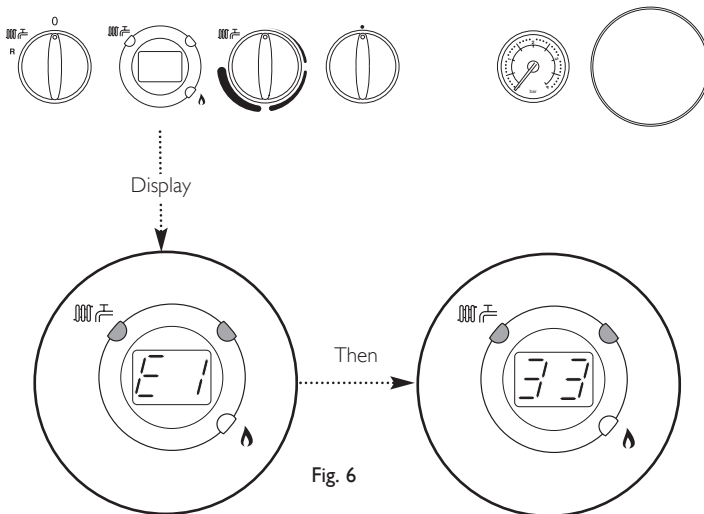

Fig. 6

Table of Error Codes

E20	Central Heating NTC Fault
E28	Flue NTC Fault
E50	Hot Water NTC Fault
E110	Safety Thermostat Operated
E119	Water Pressure Switch Not Operated
E125	Circulation Fault (Primary Circuit)
E130	Flue NTC Operated
E133	Interruption Of Gas Supply or Flame Failure
E160	Fan or Fan Wiring Fault

5.3 Fault Indication

1. If a fault occurs on the boiler an error code may be shown on the facia display.

2. The codes are either two or three digit, preceded by the letter 'E'. For example, code E133 will be displayed by 'E1' alternating with '33'. E50 is shown as 'E' then '50'.

3. E20, E28, E50, E125 & E160 indicate faulty components. You should make a note of the displayed error code and contact your installer or service engineer.

4. If E110 or E130 is displayed overheat of the primary water or flue system has occurred. Turn the selector switch to the reset position and hold for at least 5 seconds. If the boiler does not relight, or the code is displayed regularly contact your installer or service engineer.

5. E119 is displayed when the primary water pressure is less than 0.5 bar. After repressurising the system the boiler should operate. Your installer will be able to advise you about the method of repressurising. See page 6 for further details.

6. E133 indicates that the gas supply has been interrupted, ignition has failed or the flame has not been detected. Ensure that the gas supply has not been turned off, and turn the selector switch to the reset position and hold for at least 5 seconds. If the boiler does not relight, or the code is displayed regularly contact your installer or service engineer.

6.0 Legislation & Maintenance

6.1 Installation, Commissioning, Service & Repair

1. This appliance must be installed in accordance with the manufacturer's instructions and the regulations in force. Read the instructions fully before installing or using the appliance.

2. The installation must be carried out by a competent person as stated in I.S. 813 "Domestic Gas Installations".

6.2 Spare Parts

IMPORTANT - Only a competent person should be used to service or repair this boiler.

1. Any repairs to the boiler will usually be the responsibility of the Installer during the guarantee period after which spare parts may be obtained from Heatmerchants if required.

2. Quote the appliance name, model number and where possible the part number when ordering spares. A parts list is included in the Installation and Servicing Instructions.

3. The name, model number and serial number can be found on the information label on the back of the hinged lower door.

6.3 After Sales Service

1. If After Sales Service is required please telephone:-
090 6424 062.

The boiler meets the requirements of Statutory Instrument "The Boiler (Efficiency) Regulations 1993 No 3083" and is deemed to meet the requirements of Directive 92/42/EEC on the energy efficiency requirements for new hot water boilers fired with liquid or gaseous fuels:-

Type test for purpose of Regulation 5 certified by:
Notified Body 0085.

Product/Production certified by:
Notified Bodies 0085 & 0086.

For IE only.

Warning !

If you smell gas

Turn off the gas supply at the meter and call your gas supplier immediately. It is possible to isolate the boiler at the isolating valve (Fig. 8).

Faulty boiler

If it is known or suspected that a fault exists on the boiler, it must not be used until the fault has been corrected by a competent person.

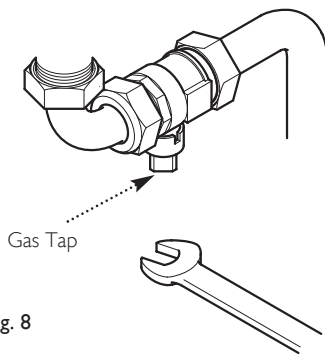
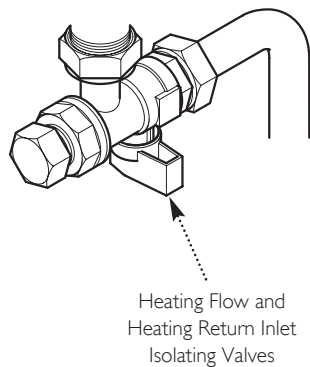

Fig. 9



In an Emergency

If a water or gas leak occurs or is suspected, the boiler can be isolated at the inlet valves as follows:

1. Using a suitable open ended spanner, turn the square nut on the gas tap through 90° (1/4 turn) in a clockwise direction to isolate the gas supply at the boiler (Fig. 8).
2. The water isolating valves are positioned under the boiler and can be closed by turning their taps to the right towards the wall (Fig. 9).
3. Call your Installer or Service Engineer as soon as possible.

Please complete the boxes below

Serial Number

Date of Installation

□	□	□	□	□	□
D	D	M	M	Y	Y

Installer Details (name, address and contact number(s))

Contact us

For general enquiries contact branches nationwide

For technical advice please contact
056 7720 023

For in warranty service contact
090 6424 062

Branches Nationwide
www.heatmerchants.ie

For technical enquiries please contact
warrantyapp@heatmerchants.ie

All descriptions and illustrations provided in this leaflet have been carefully prepared but we reserve the right to make changes and improvements in our products which may affect the accuracy of the information contained in this leaflet. All goods are sold subject to our standard Conditions of Sale which are available on request.

BAXI
A Trading Division of Baxi Heating UK Ltd (3879156)
Brooks House, Coventry Road, Warwick. CV34 4LL
Website www.baxi.co.uk
e&oe

PART OF BDR THERMEA