CHALLENGER

Installation and servicing instructions
MODEL :

80 E

Type C
with Sealed Combustion Chamber

G.C. NUMBER: 4711605

Produced by Merloni TermoSanitari ^{spa} - Italy

**LEAVE THESE INSTRUCTIONS
ADJACENT TO THE GAS METER**

TABLE OF CONTENTS

Sect. No.	Subject	Page	Sect. No.	Subject	Page
1	GENERAL INFORMATION		6.15	Gas modulator cartridge	26
1.1	Overall view	2	6.16	Gas modulator coil	27
1.2	Technical data	3	6.17	On-off operator coils	27
1.3	Available pump head	4	6.18	Gas valve	27
1.4	Flue pipes optional extras	4	6.19	Removing the fan	28
1.5	Design principles and operating sequence	4	6.20	Air pressure switch	28
			6.21	Main heat exchanger	29
			6.22	Automatic air purger	29
2	GENERAL REQUIREMENTS		6.23	Pump	30
2.1	Related documents	6	6.24	Pump pressure switch	30
2.2	Location of appliance	6	6.25	Main circuit flow switch	30
2.3	Flue system	6	6.26	Temperature pressure gauge	31
2.4	Gas supply	6	6.27	Removing diverter valve	31
2.5	Air supply	7	6.28	Secondary exchanger	31
2.6	Water circulation	7	6.29	Expansion vessel	32
2.7	Domestic water	8	6.30	Safety valve	32
2.8	Electrical supply	8			
3	INSTALLATION		7	FAULT FINDING	
3.1	Delivery	9	7.1	Total check system	33
3.2	Measurements for installing the appliance	9	7.2	Special defects	33
3.3	Unpacking the boiler	10	7.2.1	Water leaks	33
3.4	Positioning of the boiler	10	7.2.2	Difficulty in lighting the burner	33
3.5	Mounting the flue exhaust pipes	11	7.2.3	Incorrect combustion	34
3.6	Flue terminal guard	13	7.2.4	Traces of gas or exhaust flues	34
3.7	Electrical connections	13	7.3	Installation of the TCS	34
			7.4	Fault finding	34
			7.5	Fault finding without the utilization of the total check system	48
4	COMMISSIONING		7.5.1	Appliance completely shut down	48
4.1	Electrical installation	15	7.5.2	Appliance doesn't attempt to ignite the burner (no sparks)	49
4.2	Gas supply installation	15	7.5.3	Appliance ignition frequently fails with consequent lockout (red light on the reset push button)	50
4.3	Filling the d.h.w. system	15	7.5.4	Fault on "hot water-space heating" switching	51
4.4	Initial filling of the system	15			
4.5	Setting the system pressure	16			
4.6	Lighting the boiler	16			
4.7	Checking the full sequence control	16			
4.8	Testing the d.h.w. system flow	16			
5	MAINTENANCE		8	ELECTRIC DIAGRAMS	
5.1	General	17	8.1	Electrical connection	52
5.2	Recommended routine maintenance	17	8.2	Functional flow connection	53
6	SERVICING INSTRUCTIONS		9	SHORT SPARE PARTS LIST	54
6.1	Replacement of parts	18	.	Control panel	
6.2	To gain access	18	.	Residual head of circulator	
6.3	To drain the main circuit of the boiler	19	.	Regulating heating power for Natural Gas (G20)	
6.4	To drain the d.h.w. circuit of the boiler	19	.	Regulating heating power for Butane Gas (G30)	
6.5	Setting gas pressure	20	.	Regulating heating power for Propane Gas (G31)	
6.6	Overheat thermostat	22			
6.7	Removing ignition electrodes	22			
6.8	Removing flame sensor	23			
6.9	Removing d.h.w. thermostat	24			
6.10	Boiler thermostat	24			
6.11	EMC filter (radio interference surpressor)				
25					
6.12	Microswitches on diverter valve	25			
6.13	Burner and injectors	25			
6.14	Insulation panel	26			

IMPORTANT INSTRUCTIONS

Read the instructions and recommendations in this owner's manual carefully to ensure proper installation, use and maintenance of the appliance.

Keep this owner's manual in a safe place. You may need it for your own reference while our Servicing Centre technicians or your installer may need to consult it in the future.

WARNING

This appliance is designed to produce hot water. It must be connected to a central heating system or to hot water mains system suited to its specifications and capacity.

This appliance **MUST BE USED ONLY** for the purpose for which it is designed. The manufacturer declines all liability for damage caused by improper or negligent use.

BEFORE CONNECTING the appliance check that the information shown on the data plate and the table on pages 4-5 comply with the electric, water and gas mains of your home. You will find the data plate on the control panel. The gas with which this appliance operates is also shown on the label at the bottom of the boiler.

DO NOT install this appliance in a damp environment or close to equipment which spray water or other liquids.

DO NOT PLACE objects on the appliance.

DO NOT ALLOW children or inexperienced persons to use the appliance without supervision.

If you smell gas in the room, **DO NOT TURN ON** light switches, use the telephone or any other object which might cause sparks.

Open doors and windows immediately to ventilate the room. Shut the gas mains tap (on the gas meter) or the valve of the gas cylinder and call your Gas Supplier immediately. If you are going away for a long period of time, remember to shut the mains gas tap or the gas cylinder valve.

ALWAYS DISCONNECT the appliance either by unplugging it from the mains or turning off the mains switch before cleaning the appliance or carrying out maintenance.

IN THE CASE OF FAULTS OR FAILURE, switch off the appliance and turn off the gas tap. Do not tamper with the appliance.

For repairs, call your local Authorized Servicing Centre and request the use of original spare parts. For in guarantee repairs contact MTS (GB) LIMITED

NEVER block the ventilation outlet of the compartment in which the boiler is installed with rags or paper.

CHECK the following at least once a year:

- 1 -Check the seal of water connections, replacing the gaskets if necessary.
- 2 -Check the seal of the gas connections, replacing the gaskets if necessary.
- 3 -Check the general condition of the appliance and of the combustion chamber visually
- 4-Visual check of the combustion: clean burners if necessary.
- 5 -With reference to point 3, dismount and clean the combustion chamber if necessary.
- 6 -With reference to point 4, dismount and clean the injectors if necessary.
- 7 -Visual check of the primary heat exchanger:
 - check for overheating of the exchangers fins;
 - clean the fume side of the exchanger if necessary.
- 8 -Regulate the gas pressure, ignition pressure, partial flame, maximum flame.
- 9 -Check proper operation of the heating safety system:
 - maximum safety temperature;
 - maximum safety pressure.
- 10 -Check the proper operation of the gas safety system:
 - gas or flame safety device;
 - gas valve safety device.
- 11 -Check that the electric connections have been made in compliance with the instructions shown in the owner's manual.
- 12 -Check the efficiency of the hot water supply (flow and temperature).
- 13 -General operating check of the appliance.
- 14 -Check room ventilation.
- 15 -Check the exhaust system for the combustion products.

**FAILURE
TO FOLLOW THE
ABOVE INSTRUCTIONS
MAY COMPROMISE
THE SAFETY OF THE
APPLIANCE**

1 GENERAL INFORMATION

1.1 OVERALL VIEW

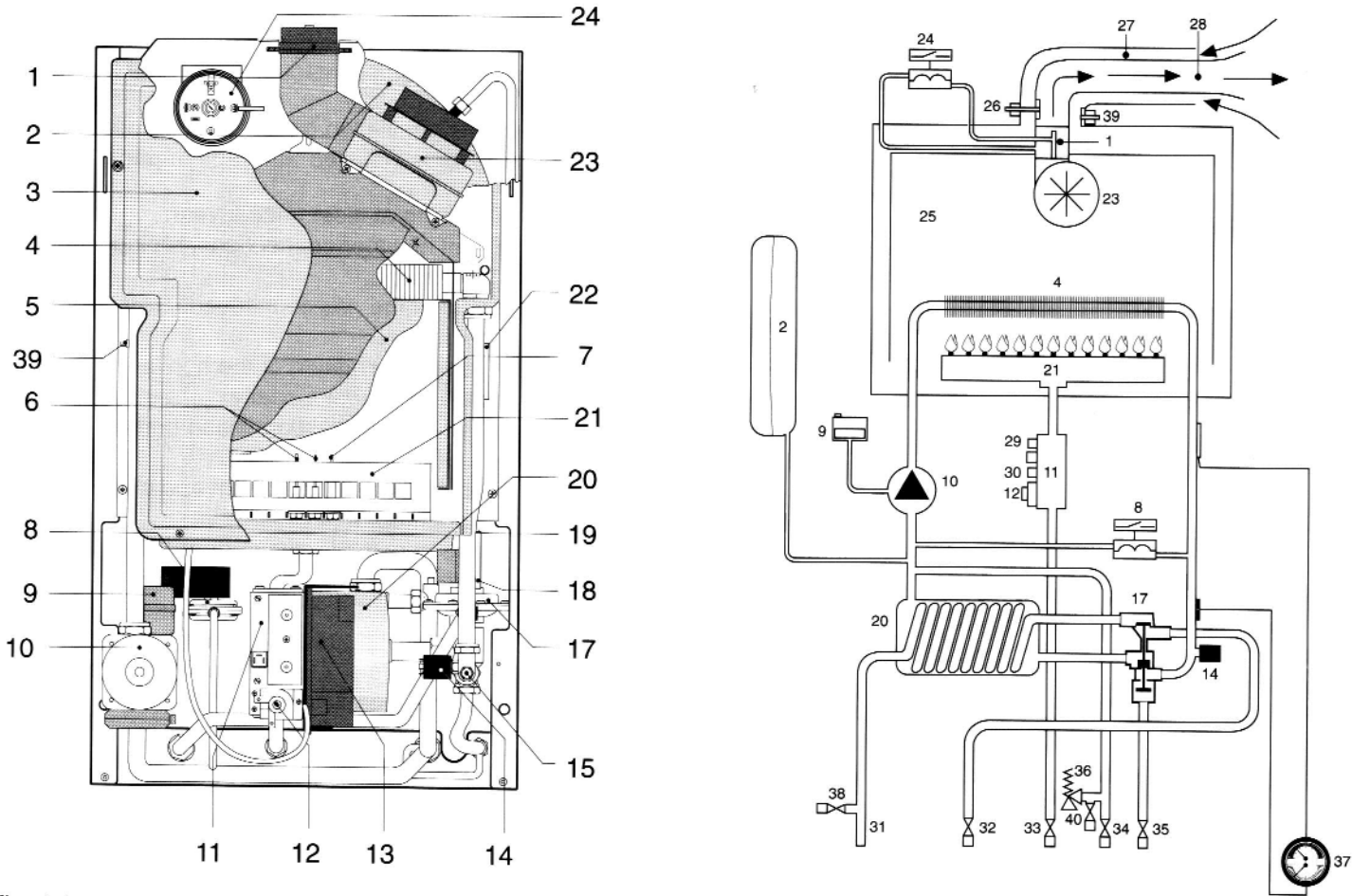

fig. 1.1

- | | |
|---|---|
| 1 - Venturi device | 23- Fan |
| 2 - Expansion vessel | 24- Air pressure switch |
| 3 - Sealed combustion chamber | 25- Combustion chamber |
| 4 - Main heat exchanger | 26- Flue gas sampling point |
| 5 - Combustion chamber insulation panel | 27- Air intake |
| 6 - Ignition electrode | 28- Flue outlet |
| 7 - Detection electrode | 29- Pressure test point for measuring outlet pressure at the gas valve ⁽¹⁾ |
| 8 - Main circuit flow switch | 30- Pressure test point for measuring inlet pressure at the gas valve ⁽¹⁾ |
| 9 - Automatic air release valve | 31- D.h.w. (domestic hot water) outlet |
| 10- Pump | 32- D.w. inlet |
| 11- Gas valve | 33- Gas inlet |
| 12- Gas modulator | 34- C.h.w. (central heating water) return |
| 13- Electronic P.C.B. | 35- C.h.w. flow |
| 14- Pump pressure switch | 36- Safety valve |
| 15- D.H.W. thermostat probe | 37- Water pressure/temperature gauge |
| 17- Divertor valve | 38- D.h.w. drain cock |
| 18- Thermometer probe | 39- Air intake temperature sampling point |
| 19- Central heating thermostat probe | 40- Main circuit drain cock |
| 20- Secondary exchanger | |
| 21- Main burner | |
| 22- Overheat thermostat probe | |

(1) Gas valve components.

General information

1.2 TECHNICAL DATA

The CHALLENGER 80 E is a combined central heating (c.h.w.) and domestic hot water (d.h.w.) appliance. It is produced as a room sealed category appliance. It is suitable for wall mounting applications only. It is suitable for sealed systems only.

Heating input	max	25.6 kW	87364 Btu/h
Heating input	min	11.0 kW	37539 Btu/h
Heating output	max	23.1 kW	78832 Btu/h
Heating output	min	8.8 kW	30031 Btu/h

CENTRAL HEATING			
Operating temperature	max	85 °C	
Operating temperature	min	45 °C	
Working pressure	max	2.5 bar	36.25 p.s.i.
Water content		2.7 lts	0.6 gals.
Built-in expansion vessel - Total capacity		7 lts	1.53 gals.
Built-in expansion vessel - Pre-charge pressure		1 bar	14.5 p.s.i.
Available head at 1000 lts./h (220 gals./h)		2.50 m w.g.	98.42 ins w.g.
Temp. difference for flow and return		20 °C	
Flow rate of water through the appliance		1000 lts./h	219.3 gals./h
Max permissible cold water capacity without additional expansion vessel ⁽¹⁾		70 lts./h	15.3 gals./h

DOMESTIC HOT WATER			
Working pressure	max	6 bar	87 p.s.i.
Working pressure	min	0.2 bar	2.9 p.s.i.
Water content		0.30 lts	0.08 gals.
Flow rate	min	2.4 lts./min	0.5 gals./min
Flow rate	30 °C rise	11.0 lts./min	2.4 gals./min
Flow rate	35 °C rise	9.5 lts./min	2.1 gals./min
Flow rate	40 °C rise	8.3 lts./min	1.8 gals./min

COMPONENT DETAILS	
Gas control valve	SIT 837 TANDEM
Burner	Atmosferic steel - POLIDORO

ELECTRICAL DATA	
Electrical supply	230 V~
Frequency	50 Hz
Power consumption	150 W
Internal fuse rating	2 A

CONNECTIONS	
Gas connection	15 mm o.d.
C.h. flow	22 mm o.d.
C.h. return	22 mm o.d.
D.c.w. inlet	15 mm o.d.
D.h.w. outlet	15 mm o.d.
Safety discharge pipe	15 mm o.d.

FLUE PIPES SPECIFICATIONS			
Outer diameters	Flue exhaust pipe	60 mm	2.36 ins
Outer diameters	Air intake pipe	100 mm	3.93 ins
Standard length		1000 mm	39.38 ins
Maximum length ⁽²⁾		3000 mm	118.1 ins

OTHER SPECIFICATIONS		
Height	796 mm	31.34 ins
Width	456 mm	17.95 ins
Depth	370 mm	14.57 ins
Dry weight	46 Kg	101.4 lb

GAS REQUIREMENTS		NATURAL GAS (G20)		BUTANE GAS (G30)		PROPANE GAS (G31)	
Gas rate	max	2.7 m ³ /h	96.0 ft ³ /h	0.8 m ³ /h	28.2 ft ³ /h	1.0 m ³ /h	36.5 ft ³ /h
Gas rate	min	1.1 m ³ /h	38.8 ft ³ /h	0.3 m ³ /h	10.6 ft ³ /h	0.4 m ³ /h	14.7 ft ³ /h
Inlet pressure		20 mbar	7.8 in w.g.	28 mbar	10.9 in w.g.	37 mbar	14.4 in w.g.
Burner pressure (Natural gas)	max	12.3 mbar	4.8 in w.g.	28 mbar	10.9 in w.g.	37 mbar	14.4 in w.g.
Burner pressure (Natural gas)	min	2.0 mbar	0.8 in w.g.	5.1 mbar	2.0 in w.g.	7.0 mbar	2.7 in w.g.
Burner injectors		13 x 1.25		13 x 0.72		13 x 0.72	

(1) If required, an external expansion vessel can be fitted

(2) Using one or more horizontally elongated flue pipes kits (see sect. 1.4)

General information

1.3 AVAILABLE PUMP HEAD

The curve at pag.57 shows the water pressure (head) available to the central heating (c.h.) circuit as a function of flow; the load loss of the appliance has already been subtracted.

1.4 FLUE PIPE OPTIONAL EXTRAS

For a full report about flue pipe optional extras, please consult the flue pipe accessories !

1.5 DESIGN PRINCIPLES AND OPERATING SEQUENCE

Water system design

The basic purpose of a boiler is to generate heat through the combustion of gas and to direct the heat through a water circuit.

A combination-type appliance allows the heat to be used either for heating the environment or for heating hot water for domestic use.

Main water circuit

This is an internal water circuit in the appliance which passes through the main heat exchanger and absorbs heat directly from the combustion of gas. The water in this circuit is the same water that is circulated by the pump and flows through the c.h. system.

The direction of the water in the main water circuit can be changed by a diverter valve. The main water circuit is connected to the c.h. circuit during operation with the c.h. system (see fig. 1.2)

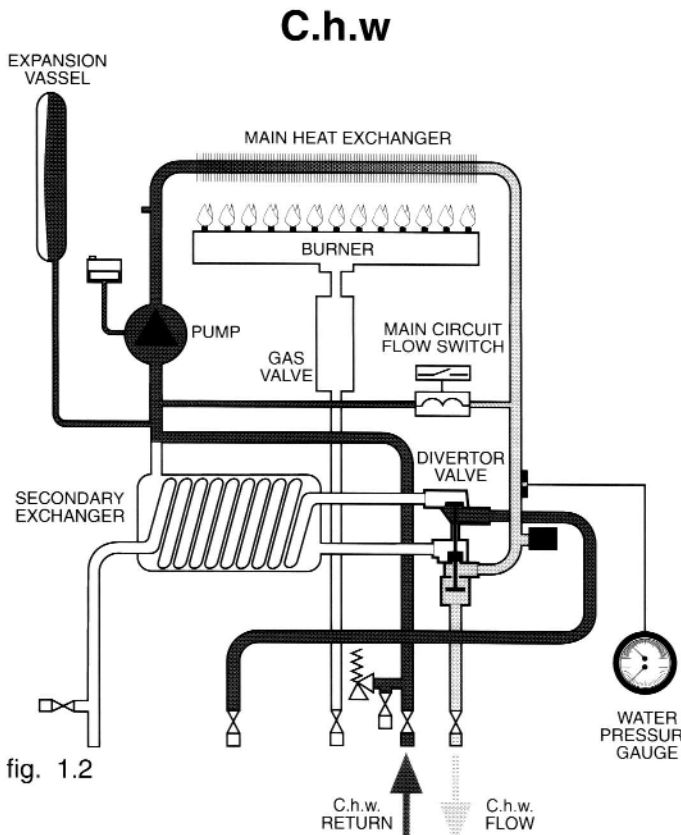

fig. 1.2

When d.h.w. is required, the main water circuit is directed through the d.h.w. heat exchanger via the diverter valve (see fig. 1.3).

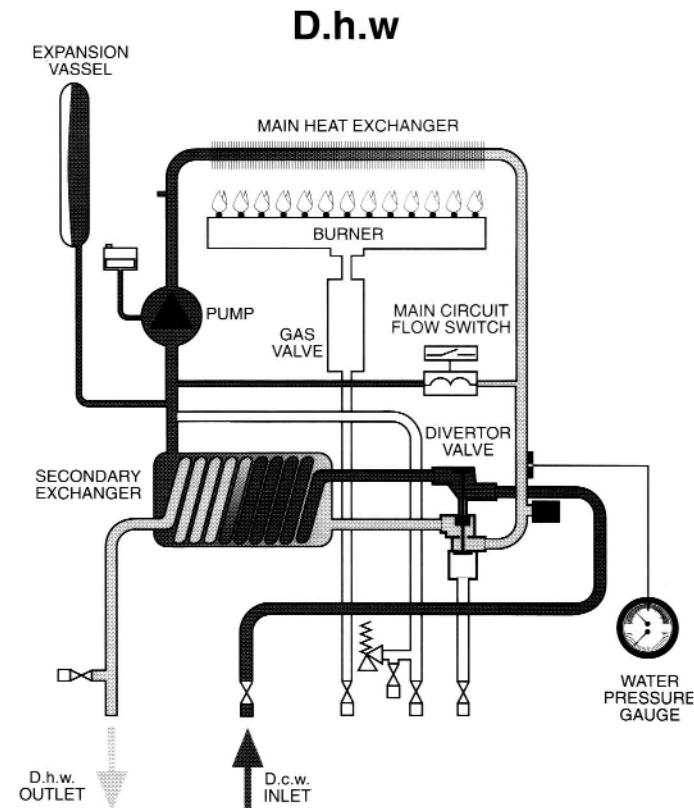

fig. 1.3

Safety device

If the flow rate in the main water circuit is insufficient, the flow switch on main water circuit disconnects the supply to the full sequence control p.c.b.

In this case the boiler is turned off in order to prevent damage.

An overheat thermostat disconnects the two ON-OFF operators on the gas valve; as a result, the burner is shut down and the shut down warning light will appear.

A safety valve is provided to relieve excess pressure from the main circuit.

The appliance is equipped with a safety system (venturi device and air pressure switch) which detects the velocity of the exhaust flues.

If the air pressure switch does not detect the correct velocity, the burner will shut down.

Operating sequence on central heating mode

The function switch must be set on position III ? .

The water in the main circuit is sent to the c.h. system when the diverter valve is in the c.h. position.

In this configuration, the diverter is in the normal position and the d.h.w. heat exchanger circuit is cut out.

The appliance is controlled by an electronic thermostat; water delivery temperature can be adjusted from 35° C to 85° C.

General information

When heat is required a command starts the fan, which switches the air pressure switch.

After the air pressure switch has been switched, the combustion chamber is purged of any residual unburned gasses for a few seconds. Next, the lighting cycle begins with a spark from the ignition electrode; at the same time, electrical power is fed to the two ON-OFF operators on the gas valve.

If the flame detection electrode does not sense the flame within 10 seconds from the beginning of the cycle, the full sequence control p.c.b. interrupts the lighting cycle, the electric spark is shut off and the power is disconnected from the two ON-OFF operators on the gas valve; as a result, the burner is shut down.

At this point, the shut down warning light appears and the reset push-button must be pressed to restart the lighting cycle.

If the detection electrode senses flame within 10 seconds from the beginning of the cycle, the full sequence control p.c.b. interrupts the electrical sparks and holds the burner alight.

At the same time, the temperature of the heating circuit is measured by the main circuit temperature probe and this temperature is compared with the value set on the c.h. temperature adjustment (III).

After lighting has been accomplished, the flow from the gas valve is determined by the electronic regulation p.c.b. :

-When the temperature of the circuit heating water (c.h.w.) is 5°C (or more) under the preset temperature, the appliance will supply its maximum preset power .

-When the temperature of the circuit heating water (c.h.w.) is just few degrees under (<5°C) the preset temperature, the appliance will supply its minimum preset power (that corresponds to 35% of the maximum rated power).

D.h.w. only operation

When the function switch is set on position Ⅱ the c.h. adjustment system is deactivated, the diverter valve is actuated and the shutter closes water delivery to the d.h.w. heat exchanger. When d.h.w. is drawn from the d.h.w. system, the appliance operates in the same way as when the function switch set on position III Ⅱ.

2 GENERAL REQUIREMENTS

This appliance must be installed by a competent installer in accordance with the 1984 Gas Safety (installation & use) Regulations (as amended)

2.1 RELATED DOCUMENTS

The installation of this appliance must be in accordance with the relevant requirements of the 1984 Gas Safety (installation & use) Regulations, the Local Building Regulations, the current I.E.E. Wiring Regulations, the by laws of the local water undertaking, and in Scotland, in accordance with the Building Standards (Scotland) Regulation. Health and safety document n° 635 " Electricity at work regs. 1989 ".

Installation should also comply with the following British Standard Codes of Practice:

Low pressure pipes	BS 6891	1988
Boilers of rated input not exceeding 60 kW	BS 6798	1987
Forced circulation hot water system	BS 5449	1990
Installation of gas hot water supplies for domestic purposes (2 nd family gases)	BS 5546	1990
Flues	BS 5540-1	1990
Air supply	BS 5540-2	1989

2.2 LOCATION OF APPLIANCE

The appliance may be installed in any room or indoor area, although particular attention is drawn to the requirements of the current I.E.E. Wiring Regulations, and in Scotland, the electrical provisions of the Building Regulations applicable in Scotland, with respect to the installation of the combined appliance in a room containing a bath or shower.

Where a room-sealed appliance is installed in a room containing a bath or shower, any electrical switch or appliance control, utilising mains electricity should be situated so that it cannot be touched by a person using the bath or shower.

The location must permit adequate space for servicing and air circulation around the appliance (see fig. 3.1-a and 3.1-a).

The location must permit the provision of an adequate flue and termination.

For unusual locations special procedures may be necessary.

BS 6798-1987 gives detailed guidance on this aspect.

A compartment used to enclose the appliance must be designed specifically for this purpose.

This appliance is not suitable for outdoor installation.

2.3 FLUE SYSTEM

The provision for satisfactory flue termination must be made as described in BS 5440-1.

The appliance must be installed so that the flue terminal is exposed to outdoor air.

The terminal must not discharge into another room or space such as an outhouse or lean-to.

It is important that the position of the terminal allows a free passage of air across at all times.

The terminal should be located with due regard for the damage or discoloration that might occur on buildings in the vicinity.

In cold and/or humid weather water vapour may condense on leaving the flue terminal.

The effect of such " steaming " must be considered.

The minimum acceptable spacing from the terminal to obstructions and ventilation openings are specified in fig. 2.1.

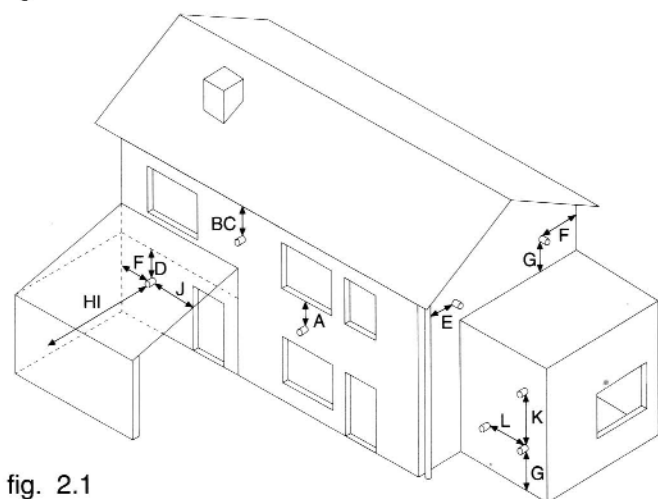

fig. 2.1

TERMINAL POSITION	mm
A - Directly below an open window or other opening	300
B - Below gutters, solid pipes or drain pipes	75
C - Below eaves	200
D - Below balconies or car port roof	200
E - From vertical drain pipes and soil pipes	75
F - From internal or external corners	300
G - Above ground or below balcony level	300
H - From a surface facing a terminal	600
I - From a terminal facing a terminal	1200
J - From an opening in the car port (e.g. door, window) into dwelling	1200
K - Vertically from a terminal in the same wall	1500
L - Horizontally from a terminal in the same wall	300

2.4 GAS SUPPLY

The gas meter is connected to the service pipe by the local gas region contractor.

If the gas supply for the boiler serves other appliances ensure that an adequate supply is available both to the boiler and the other appliance when they are in use at the same time.

Pipework must be of an adequate size. Pipes of a smaller size than the boiler inlet connection should not be used.

Installation pipes should be fitted in accordance with BS 6891-1988 and the complete installation should be tested for soundness.

General requirements

2.5 AIR SUPPLY

The room in which the boiler is installed does not require a purpose provided air vent.

If installed in a cupboard or compartement, ventilation is required for cooling.

Recommendations for air supply are detailed in BS 5440-2;

the following notes are for general guidance:
the minimum effective area requirement is

230.4 cm² / 34.9 in² at high level

230.4 cm² / 34.9 in² at low level

The figures quotes relate to the ventilation requirement if the ventilation is into a room. If the ventilation is to the outside then the above sizes can be halved.

2.6 WATER CIRCULATION (Central heating)

Detailed recommendations are given in BS 6798-1987 and BS 5449-1 1990; the following notes are given for general guidance.

Pipework

Copper tubing to BS 2871-1 1977 is recommended for water pipes. Jointing should be either with capillary soldered or compression fittings.

Where possible pipes should have a gradient to ensure air is carried naturally to air release points and water flows naturally to drain taps.

should be ensured as far as possible that the appliance heat exchanger is not a natural collecting point for air. Except where providing useful heat, pipes should be insulated to prevent heat loss and avoid freezing. Particular attention should be paid to pipes passing through ventilated spaces in roofs and under floors.

Installation of by-pass

The installation of a by-pass is essential if all of the radiators are to be fitted with thermostatic radiator valves. The suggested method of installation is shown in the diagram below, in figure 2.3.

System design

This boiler is suitable only for sealed systems.

A typical lay-out is illustrated in fig. 2.3.

Drain cocks

These must be located in accessible positions to permit the draining of the whole system. The taps must be at least 15 mm nominal size and manufactured in accordance with BS 2870-1980.

Air release points

These must be fitted at all high points where air naturally collects and must be sited to facilitate complete filling of the system.

The appliance has an integral sealed expansion vessel to accomodate the increase of water volume when the

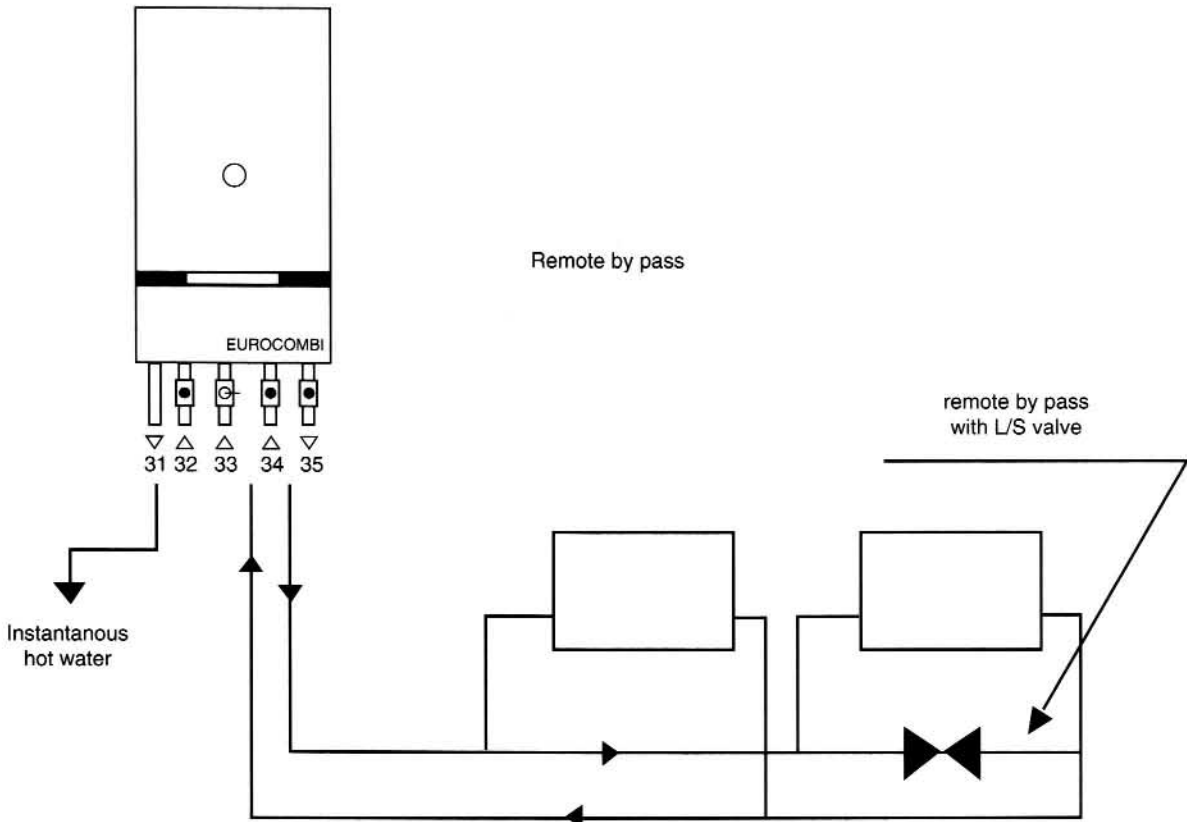

fig. 2.3

General requirements

It can accept up to 7 lts (1,5 gals.) of expansion water.

If the heating circuit has an unusually high water content, calculate the total expansion and add additional sealed expansion vessel with adequate capacity.

Mains water feed: central heating

No direct connection to the mains water supply even through a non return valve, may be made without the approval of the Local Water Authority.

Filling

A method for initially filling the system and replacing water lost during servicing must be provided and it must comply with local water authority regulations.

A possible method is shown in fig. 2.4.

The installer should ensure that no leaks exist as frequent filling of the system could cause premature scaling of the heat exchanger.

2.7 DOMESTIC WATER

The domestic water must be in accordance with the relevant recommendations of BS 5546. Copper tubing to BS 2871-1 is recommended for water carrying pipework and must be used for pipework carrying drinking water.

2.8 ELECTRICAL SUPPLY

Warning, this appliance must be earthed.

External wiring to the appliance must be carried out by a qualified technician and be in accordance with the current I.E.E. Regulations and applicable local regulations .

More over this appliance is supplied for connection to a 230 V- 50 Hz supply.

The supply must be fused at 3 A.

The method of connection to the electricity supply must facilitate complete electrical isolation of the appliance by the use of a fused double pole isolator having a contact separation of the least 3 mm in all poles or alternatively, by means of a 3 A fused three pin plug and unswitched shuttered socket outlet both complying with BS 1363.

The point of connection to the Electricity supply must be readily accessible and adjacent to the appliance unless the appliance is installed in bathroom when this must be sited outside the bathroom.

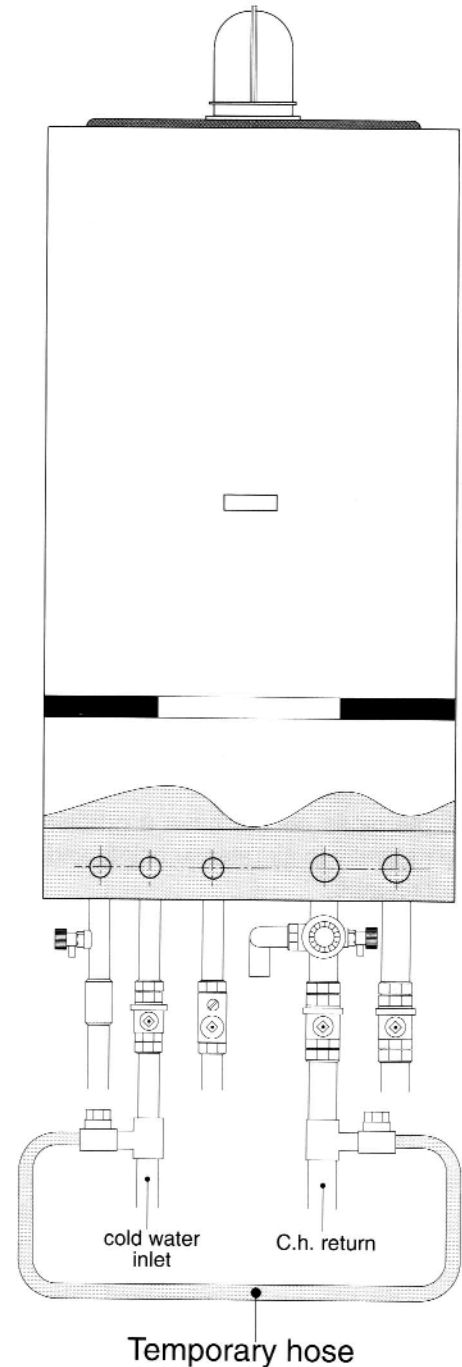

fig. 2.4

3 INSTALLATION

3.1 DELIVERY

There will be 3 items:

- 1- The fully assembled boiler;
- 2- A box containing cocks and pipes;
- 3- Standard flue assembly which include flue pipes and 90° elbow

3.2 MEASUREMENTS FOR INSTALLING THE APPLIANCE

Model CHALLENGER 80 E

To allow easy access to the interior of the boiler for maintenance work, ensure that at least the minimum dimensions shown in the drawing are used.

IMPORTANT!

To allow easy access to the interior of the boiler for maintenance work, keep to the minimum dimensions shown in the drawing.

fig. 3.1

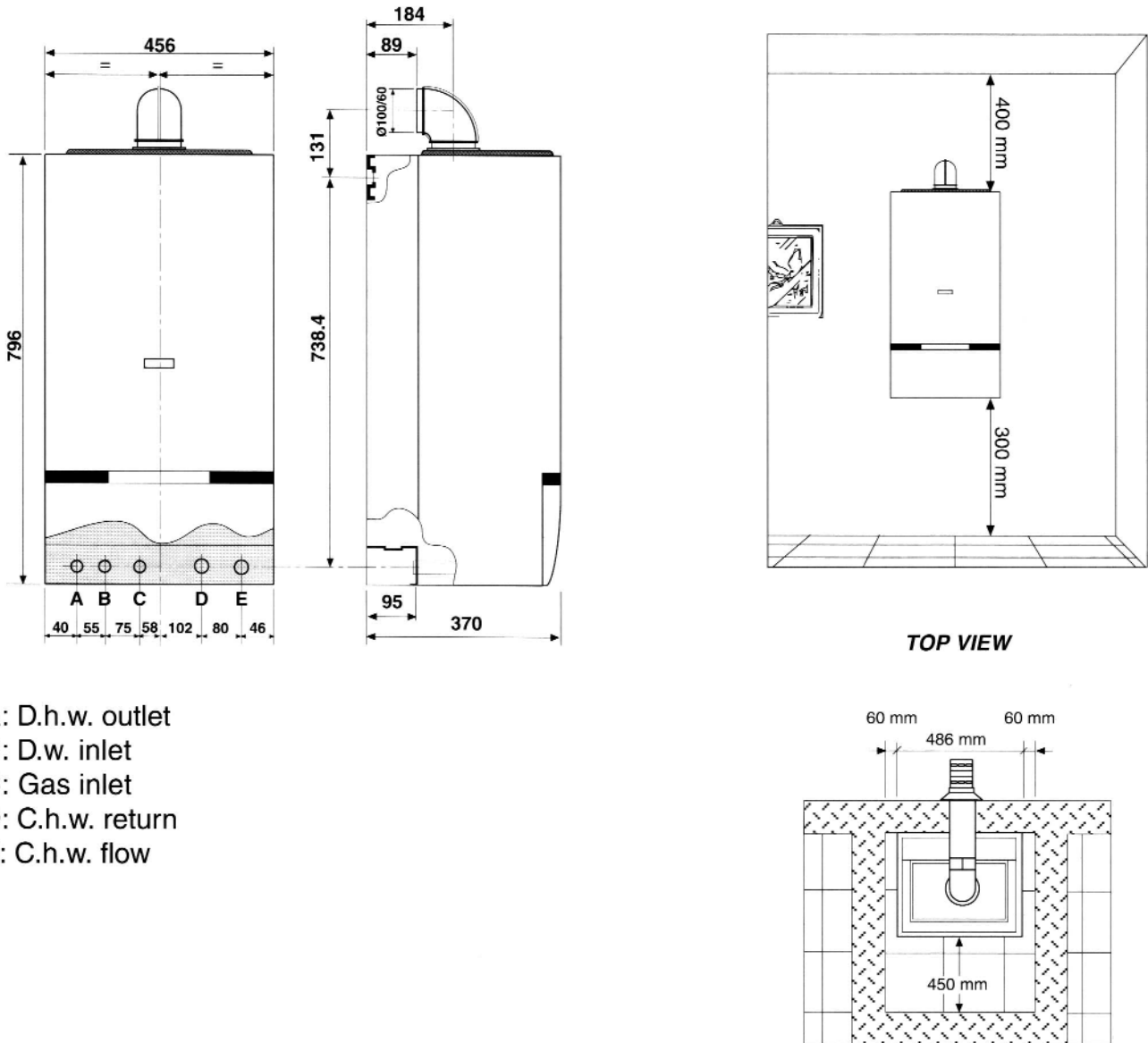

Installation

3.3 UNPACKING THE BOILER

(see fig. 3.2).

- 1- Rest the carton on the floor (keeping the flap open);
- 2- Turn the carton over, with the boiler inside and then remove the carton;
- 3- Rest the boiler on the floor and remove the polystyrene packing;
- 4- When lifting the boiler, it is important to lift it by its frame as shown.

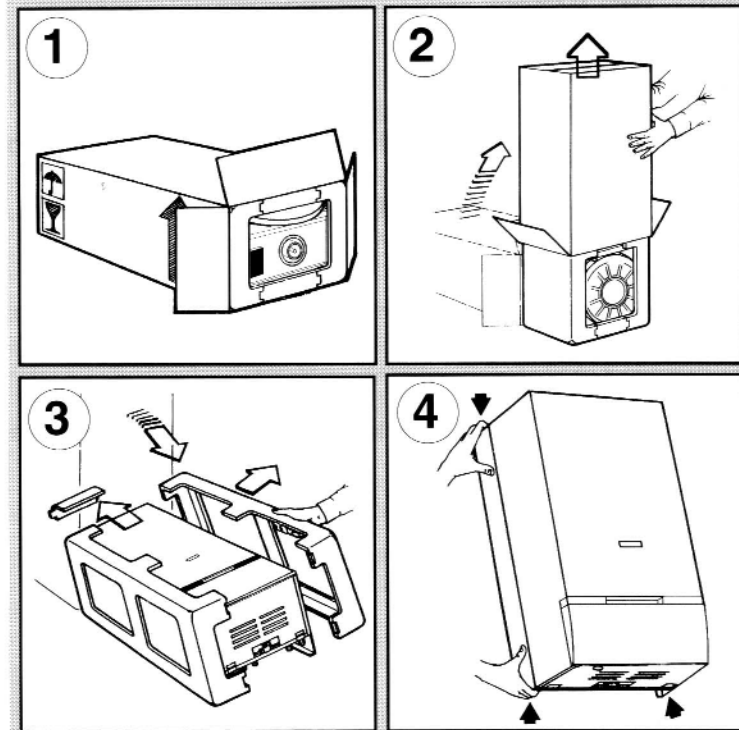
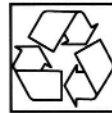

fig. 3.2

IMPORTANT!

All of the boiler packaging (carton and polystyrene) is fully recyclable.



IMPORTANT!

All packaging must be properly and thoroughly disposed of, as some components (i.e. : polythene, staples etc.) could prove to be dangerous to young children.

3.4 POSITIONING OF THE BOILER

(see fig. 3.3).

- 1- After the siting position has been determined, allowing for clearances as shown in section 3.1, fix paper template to the wall;
- 2- Drill holes for flue "A" (A = 110 mm diam.) and wall plate fixing "B" (B = 14 mm diam.);
- 3- Plumb service pipes to position "C";
- 4- Remove template from wall.
Position hanging plate "D" and secure to wall via pre-drilled holes "B" ensuring that it is level.
Important : please ensure that the fixing method used is able to support 60 Kg.

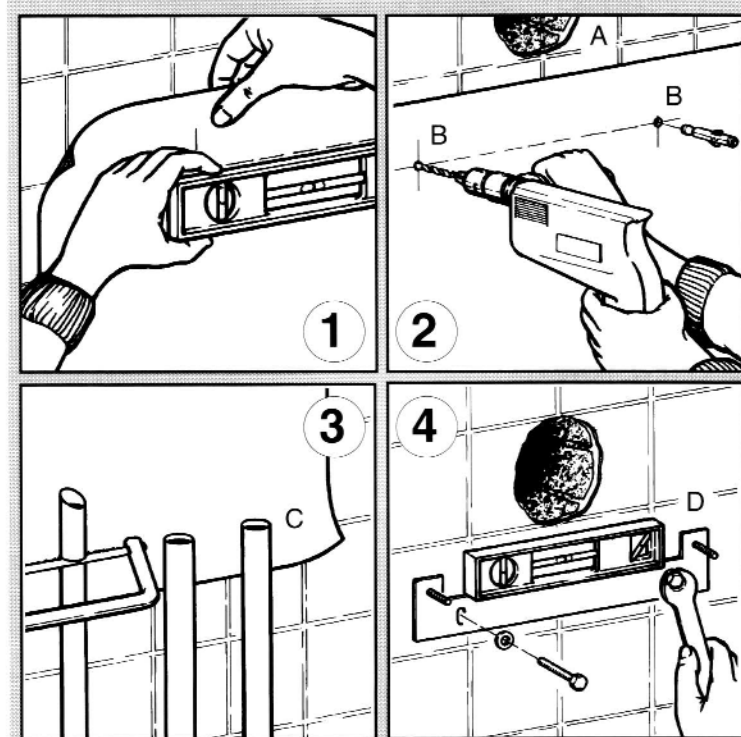

Installation

5- Mount fitting valves connections;

6- Hang the boiler on to bolts via holes in the boiler frame "F";

7- Secure boiler with nuts "G" ensuring that washers are positioned between the nut and the boiler frame.

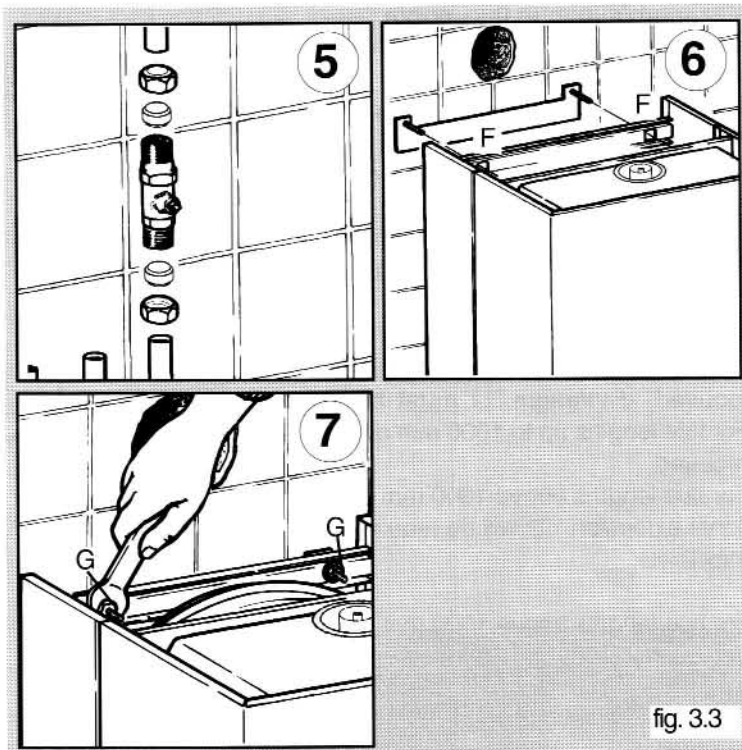

fig. 3.3

NOTE:

During the drilling of hole for the flue air intake, ensure that its diameter is bigger than the pipe that will be fitted.

This is to ensure that the pipe can be removed if required.

The sealant between the pipe and the wall is assured by internal and external flange (see figure below).

3.5 MOUNTING THE FLUE EXHAUST PIPES

Flue kit contains the following (see fig. 3.4):

- 1- Seal gasket for 90° elbow to boiler;
- 2- 60 diam. O-Ring - coloured red;
- 3- 100/60 diam 90° elbow with internal recess for 60 diam. O-Ring;
- 4- 60 diam. O-Ring - coloured red;
- 5- Flue sealant gasket;
- 6- Tightening band for sealant gasket;
- 7- Internal flange - coloured white;
- 8- External flange - coloured grey;
- 9- Flue pipe - consisting of 100 diam. outer flue, 60 diam. inner flue spring pipe support and wind-resistant terminal;
- 10- 4,2x13 self tapping screws ;
- 11- Diaphragm for use with flue requirements between 50 cm and 100 cm.

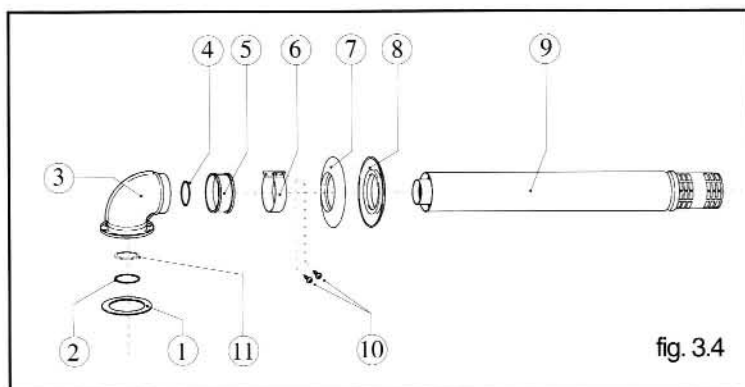

fig. 3.4

Cutting the flue exhaust

If your particular installation requires you to shorten the flue, see the following instructions for cutting measures.

N.B. : When shortening the flue pipe, cut the external 100 diam. pipe and the internal 60 diam. pipe, keeping the

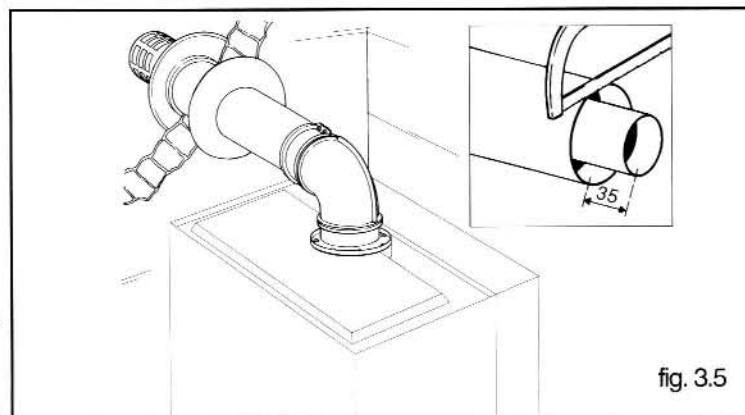

fig. 3.5

Installation

Maximum/minimum flue length

If you need to extend the flue or change its direction, optional kits are available.

All measures are in millimetres unless otherwise specified.

Both pipes must be cut on the side facing the elbow.

- 1 - Minimum flue length 'S' 500 mm (see fig. 3.5)
- 2 - Maximum flue length 'S' 3000 mm

Note:

Where flue lengths between 500 mm and 1000 mm are required, diaphragm '11' **must** be installed (see fig.3.4). For flue lengths up to 1000 mm only the standard flue kit is required.

For flue lengths above 1000 mm and up to 3000 mm additional extension kits will be required.
max 2 kits.

For flue lengths above 1000 mm the diaphragm '11' **must not** be installed.

For a full list of flue pipe optional extras, please consult the flue pipe accessories !

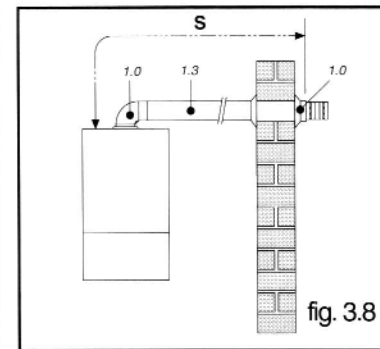
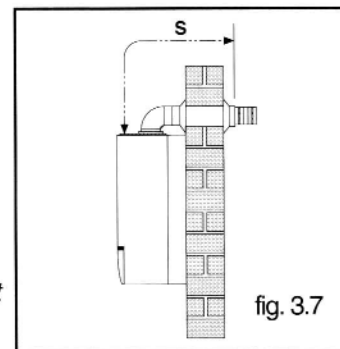
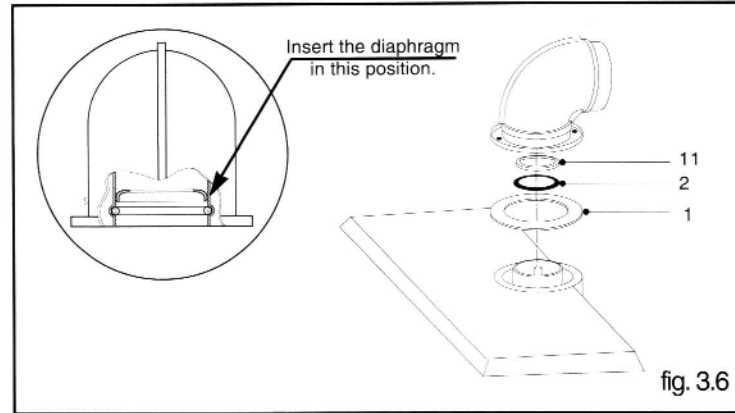

Mounting operations (see fig.3.9)

1- Fit the 100 diam. gasket into the housing at the top of the boiler and place the two 60 diam. O-Rings in the elbow housing. Insert diaphragm if required;

2- Fix the elbow at the top of the boiler using the 4 self-tapping screws and insert the stepped sleeve;

3- Fit the external ring gasket and then insert the pipe (from the outside) into the hole made in the wall ;

4- Fit the internal ring gasket ;

5- Connect the flue pipe to the bend; insert the 60 diam. pipe into the elbow through to the end and the 100 diam. pipe into the sleeve;

6- Use the clamp to fix the elbow and external 100 diam. pipe together.

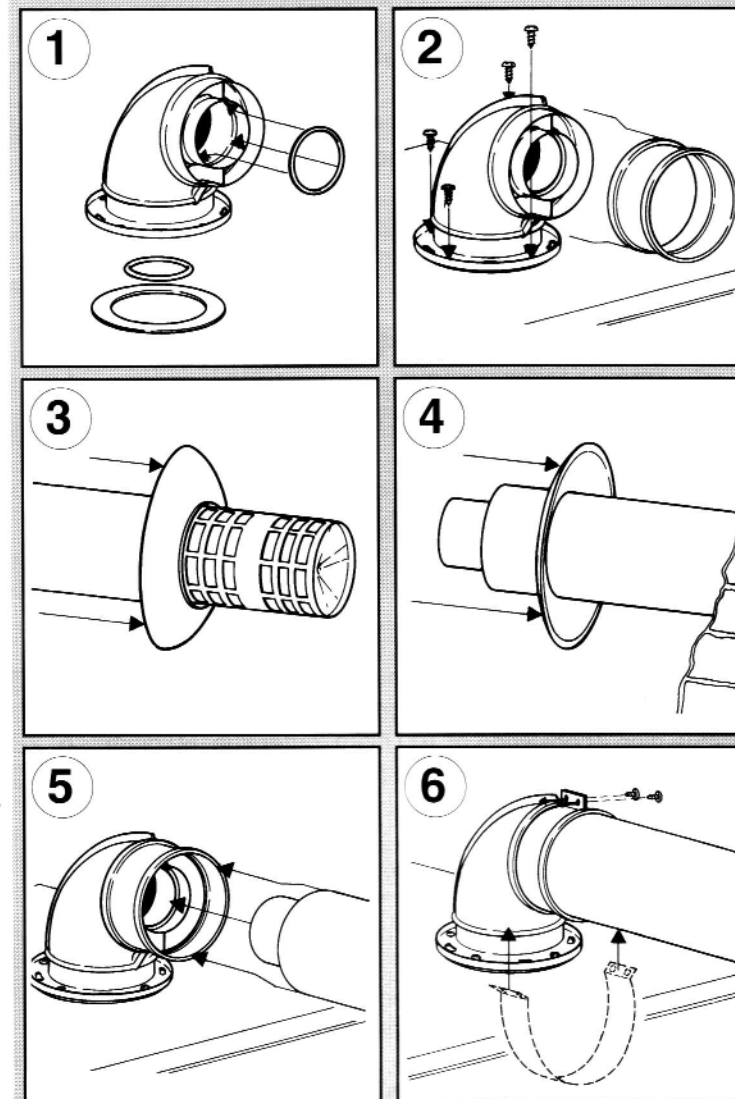

fig. 3.9

Installation

3.6 FLUE TERMINAL GUARD

Where the lowest part of the terminal is less than 2 m (6.5 ft) above the level of any ground, balcony, flat roof or place to which any person has access then a suitable terminal guard must be fitted. A suitable guard is available from:

TOWER FLUE COMPONENTS

Morley Road
Tonbridge
Kent TN19 1RA

When ordering the guard, quote appliance model number.
The guard should be fitted centrally over the terminal.

3.7 ELECTRICAL CONNECTIONS

Connecting to the electricity supply

WARNING - THIS APPLIANCE MUST BE EARTHED

The appliance is delivered with a flexible cable for electrical supply. The cable allows the electrical connection as detailed in sect. 2.8 .

Replacing the electrical supply cable

- 1 - Ensure electricity is switched off at main isolator;
- 2 - Remove boiler casing (see sect. 6.2);
- 3 - Lower the control panel (see sect. 6.2);
- 4 - Release the thermal water gauge;
- 5 - Remove the cables from the terminals by loosening screws "A" (see fig.3.10);
- 6 - Loosen screw "B" to slacken the cable holder (see fig. 3.11);
- 7 - Remove the cable;
- 8 - Insert the new cable through grommet.
A PVC insulated flexible cable must be used. it must be a three core of size 0.75 mm² (24x0.2 mm) to BS6500 table 16;
- 9 - Connect the cable to the terminals marked as follows:
 - L Brown or red wire (live)
 - N Blue or black wire (neutral)
 - ⚡ Green/yellow or green wire (earth);
- 10 - Replace the thermal water gauge.

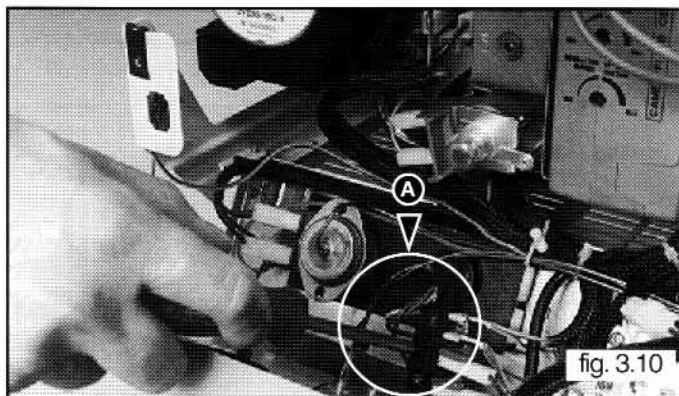

fig. 3.10

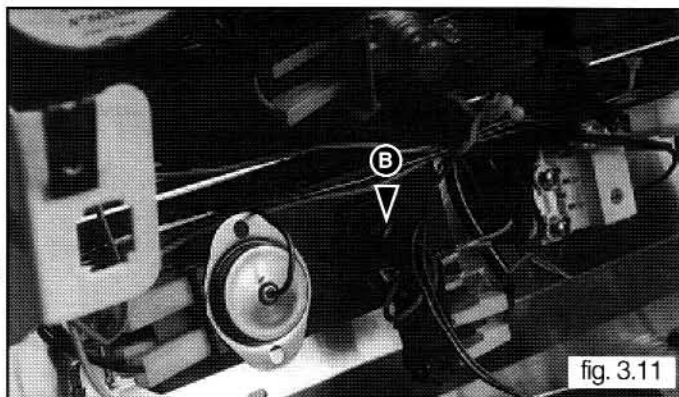

fig. 3.11

Electrical connection of a room thermostat (see fig.3.12)

- 1- Fit the cables of the room thermostat into the silicone cable holders on the manifold of the frame (1) and on the back fold of the instrument panel (2);
- 2- "Remove the top lid of the junction block "A" (see fig. 3.13).
Remove the terminal strip of the room thermostat/time clock "B" - this will help you fit the cables more easily".

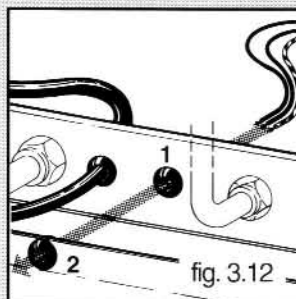

fig. 3.12

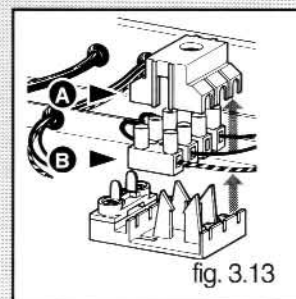

fig. 3.13

Installation

- 3- Remove the brown U-link (see fig. 3.14).
Release the two screws of the cable clamber (see fig. 3.15).
Fit wires of the room thermostat and the earth wire to the terminal board; ensuring that these ones pass through the corresponding slot.
- 4- Replace the top lid of the terminal board and the cable clamber.
Tighten the two screws firmly (see fig. 3.16).

WARNING:

When a room thermostat is used it must be of a type which can only be opened by using a tool.

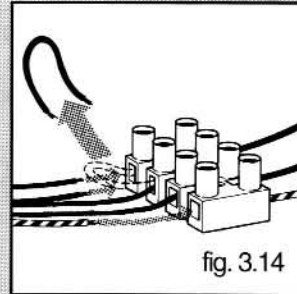

fig. 3.14

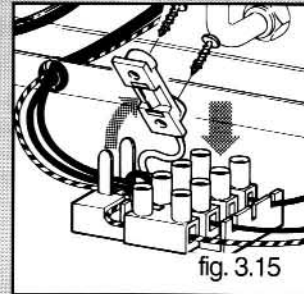

fig. 3.15

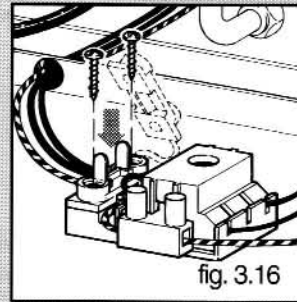

fig. 3.16

4 COMMISSIONING

4.1 ELECTRICAL INSTALLATION

Preliminary electrical system checks to ensure electrical safety must be carried out by a qualified electrician.

i.e. polarity, earth continuity, resistance to earth and short circuit.

If a fault has occurred on the appliance the fault finding procedure should be followed as specified under the servicing section of this document.

4.2 GAS SUPPLY INSTALLATION

- 1 Inspect the entire installation including the gas meter, test for soundness and purge, as described in BS6891;
- 2 Open the gas cock (drawn with the knob in "open" position on the appliance) and check the gas connector on the appliance for leaks (see fig. 4.1).

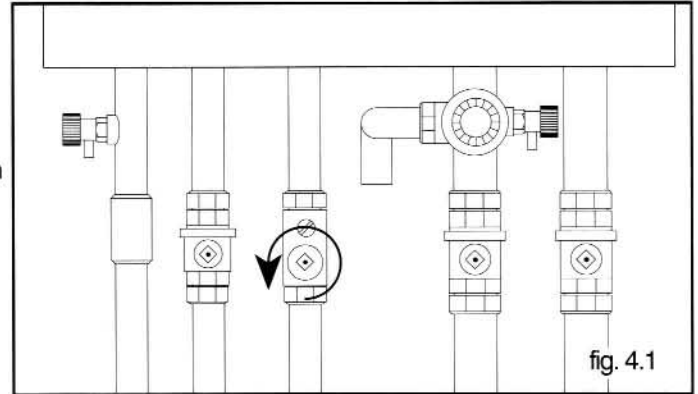

4.3 FILLING THE D.H.W. SYSTEM

- 1 Close all hot water draw-off taps;
- 2 Open the cold water inlet cock as indicated in fig. 4.2;
- 3 Slowly open each draw-off tap and close it only when clear water, free of bubbles, is visible.

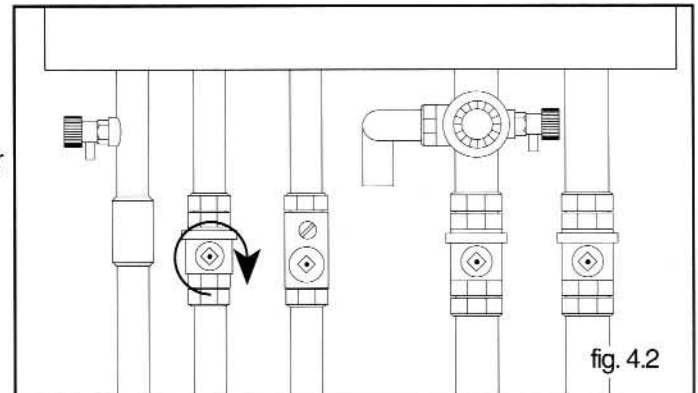

4.4 INITIAL FILLING OF THE SYSTEM

- 1 Open central heating flow and return cocks as indicated in fig. 4.3;
- 2 Remove the front panel of the case and lower the control panel (sect. 6.2);
- 3 Unscrew the cap on the automatic air release valve one full turn and leave open permanently;
- 4 Close all air release valves on central heating system;
- 5 Gradually open stopcock at the filling point connection to central heating system until water is heard to flow; do not open fully;
- 6 Open each air release tap starting with the lower point and close it only when clear water, free of bubbles, is visible;
- 7 Purge the air from the pump by uncrewing anticlockwise the pump plug as indicated in fig. 4.4;
- 8 Close the pump plug;
- 9 Continue filling the system until at least 1 bar (14.5 p.s.i.) registers on the temperature-pressure gauge;

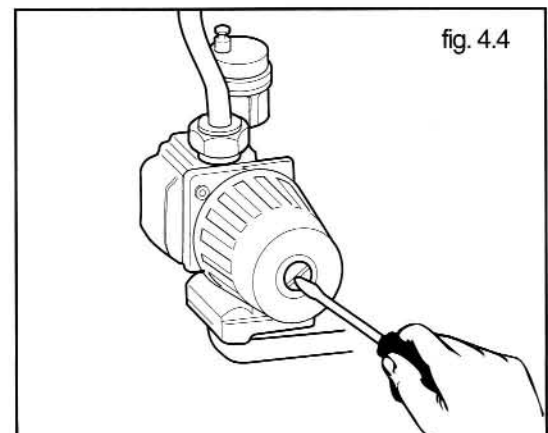
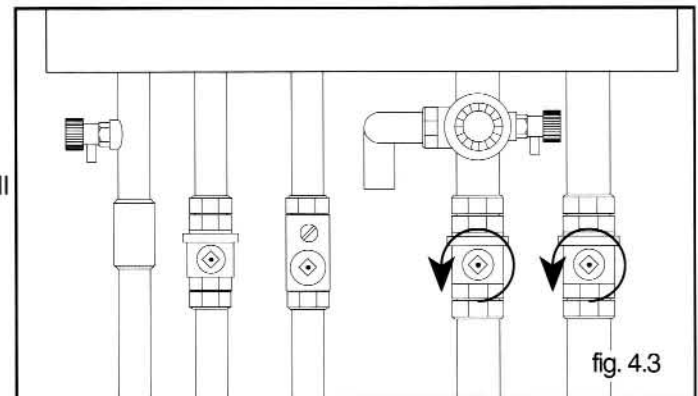

Commissioning

When the installation and filling are completed turn on the central heating system (sect. 4.5) and run it until the temperature has reached the boiler operating temperature. The system must then be immediately flushed through. The flushing procedure must be in line with BS7593:1992 *treatment of Water in Domestic Hot Water Central Heating Systems*.

During this operation, we highly recommend the use of a central heating flushing detergent, whose function is to dissolve any foreign matter which may be in the system i.e. Fernox Superfloc or equivalent.

Substances different from these, could create serious problems to the pump or others components.

We also recommend the use of an inhibitor in the system such as Fernox MB1 Universal or equivalent.

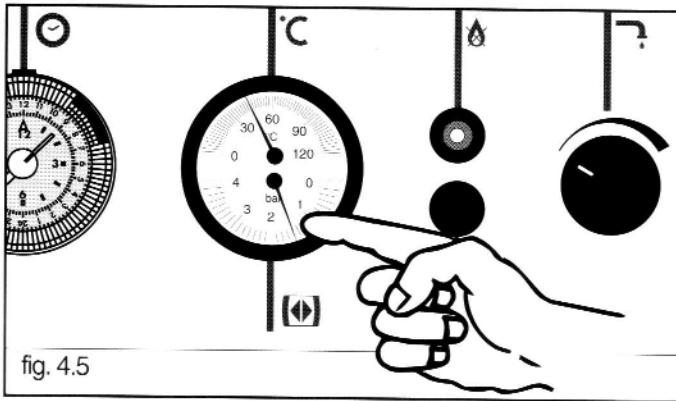

fig. 4.5

4.5 SETTING THE SYSTEM PRESSURE

The actual reading should ideally be 1.5 bar (see fig. 4.5).

4.6 LIGHTING THE BOILER

Set the time clock to manual (I) - if fitted.

If external controls are fitted e.g. Timeclock, room thermostat ensure that they " call for heat " .

- 1 Switch on the electricity and turn on boiler by pushing button "A", ensuring that the neon is on. (If neon does not come on

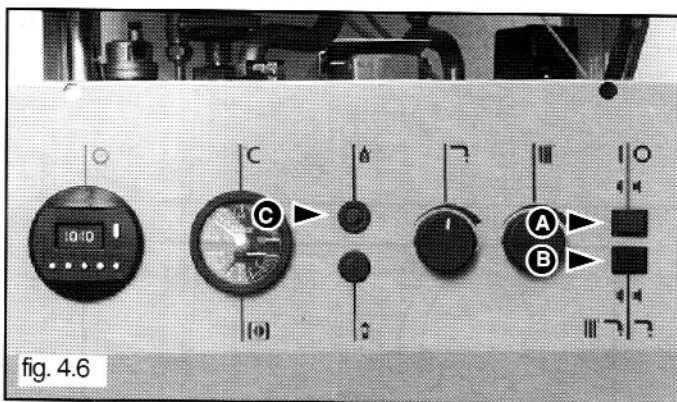

fig. 4.6

then check electrical connections) (see fig. 4.6).

- 2 Select heating mode by setting button "B" to heating mode (see fig. 4.6).
- 3 Check the burner pressures and adjust as necessary as in section 6.5.

4.7 CHECKING THE FULL SEQUENCE CONTROL

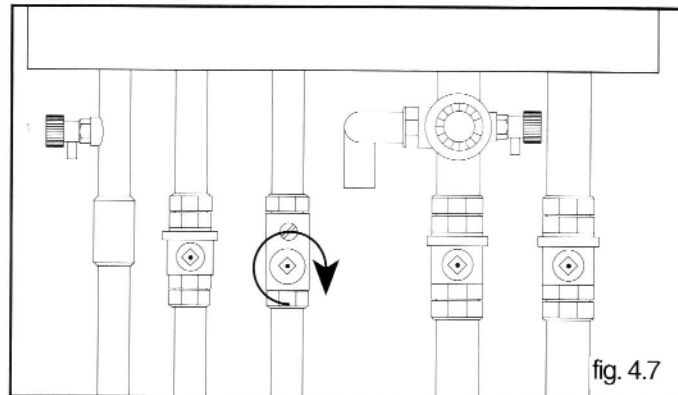

fig. 4.7

With the burner on high flame, close the gas cock turning the screw in a clockwise direction (see fig. 4.7); After several seconds, the shut-down warning light will appear.

To reset the boiler, depress the reset push button "C" marked with the symbol ϕ (see fig. 4.6).

4.8 TESTING THE D.H.W. SYSTEM FLOW

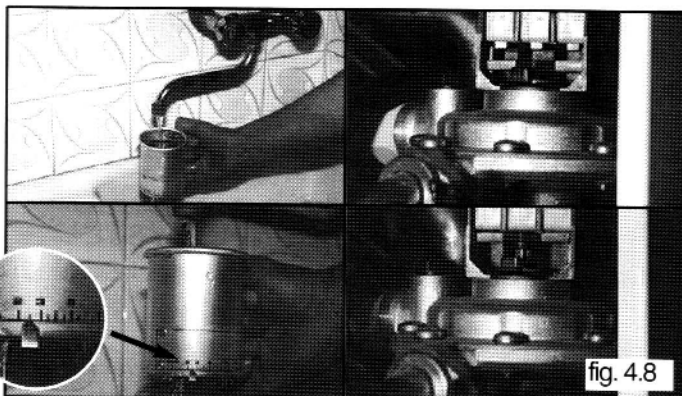

fig. 4.8

- 1 Turn the function switch as indicated and check the switching flow rate that should be at minimum 2.5 lts/min (0.66 gals/min);(see fig. 4.8)

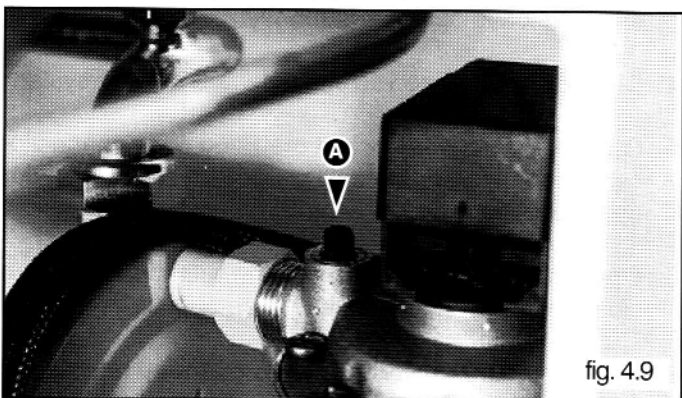

fig. 4.9

- 2 To set maximum flow
 - Turn on the tap with maximum water flow fully (e.g. bathtub);
 - Using a flow meter, set the flow on 13 lts/min (3.43 gals/min) by turning screw "A" (see fig. 4.9).

5 MAINTENANCE

5.1 GENERAL

To ensure efficient safe operation of the appliance it is necessary to carry out routine maintenance at regular intervals.

The frequency of servicing will depend upon the particular installation conditions and the use of the boiler, but, in general, once a year should be adequate.

The following notes apply to the appliance but it should be remembered that attention must be also paid to the central heating and domestic hot water circuits with special attention to radiator valves; thermostats, clocks, leaking hot water taps etc.

WARNING

Before starting any servicing work, switch-off the electrical supply or disconnect the plug at the main isolating switch and socket (if a switch is used remove the fuse).

After any service on electrical components carry out a preliminary electrical checks; in particular:
earth continuity;
polarity;
earthing resistance.

5.2 RECOMMENDED ROUTINE MAINTENANCE

The following procedures should be carried out at least once a year:

- 1 Verify that the electrical connections, the flue pipework and the case are in good condition;
- 2 Inspect ventilation arrangements as explained in section 2.5 to ensure no alterations have been made since installation;
- 3 Switch-off the electrical supply and remove the front panel of the case (section 6.2);
- 4 Switch-on the electrical supply and run the boiler for few minutes in d.h.w. mode;
- 5 Check that the flame covers all the flame ports and is of a light blue colour. Yellow flames and excessive lifting of flames indicate poor combustion.
- 6 Visually check the flue system for soundness. Check all clamps, gaskets and fixings are secure and tight. To check the exhaust gas, remove the screw indicated in fig. 5.1 and connect the analyser to the flue gas sampling point.

To inspect and clean the appliance

- 7 Switch-off the electrical supply, remove the sealed chamber cover and open the combustion chamber (section 6.2);
- 8 If during initial check any combustion irregularity is suspected, remove the burner and the injectors (section 6.13).
Clean or replace if necessary;
- 9 Inspect the main heat exchanger for any deposits of soot. If cleaning is necessary place a cloth over the burner to catch debris and clean the main heat exchanger using a soft brush.
Do not use brushes with metallic bristles;
- 10 Inspect the combustion chamber panels.
Damaged panels should be replaced;
- 11 Examine the fan for any mechanical damage and check to ensure free running of the fan motor;
- 12 Check sealing gaskets and replace if required;
- 13 Replace all parts in reverse order with the exception of the case and the control panel;
- 14 Undertake a complete commissioning check as detailed in section 4;
- 15 Close-up the control panel and the case;
- 16 Clean the case using a soft cloth.

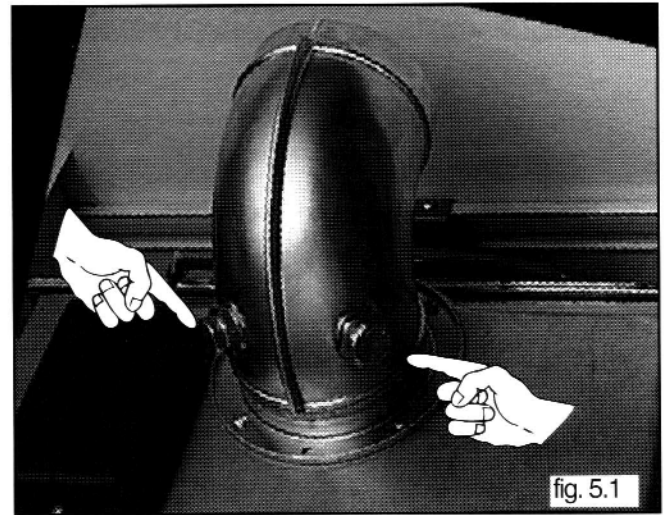

6 SERVICING INSTRUCTIONS

6.1 REPLACEMENT OF PARTS

The life of individual components varies and they will need servicing as and when faults develop.

The fault finding sequence chart in chapter 7 will serve to locate which component is the cause of any malfunction, and instructions for removal, inspection and replacement of the individual parts are given in the following pages.

6.2 TO GAIN GENERAL ACCESS

All testing and maintenance operations on the boiler require the control panel to be lowered. These operations also require the removal of the casing.

The casing is fixed to the boiler frame by screws (see fig.6.1):

- 1- Remove the four screws located at the bottom of the boiler;
- 2- Remove the two screw located at the front of the boiler;
- 3- Pull up the case;
- 4- For easy access to the interior of boiler, remove the two screws as shown in the figure 4, and support the panel whilst lowering.

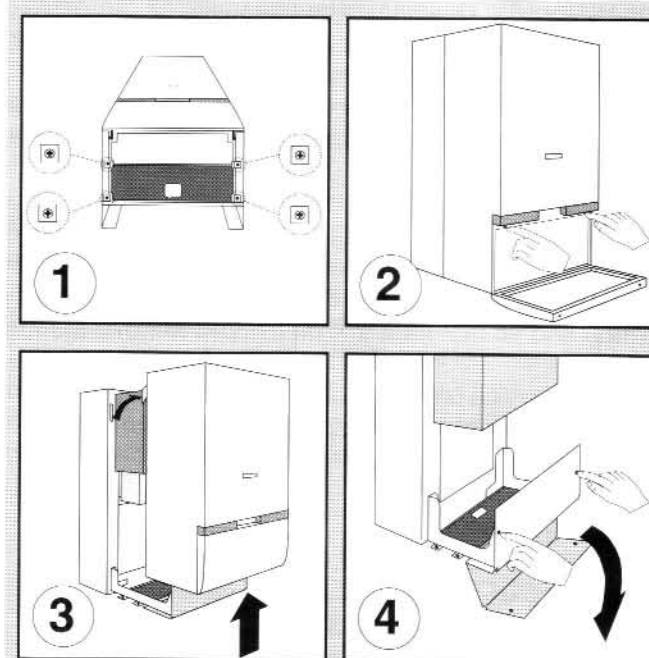

fig. 6.1

Removing the sealed chamber cover

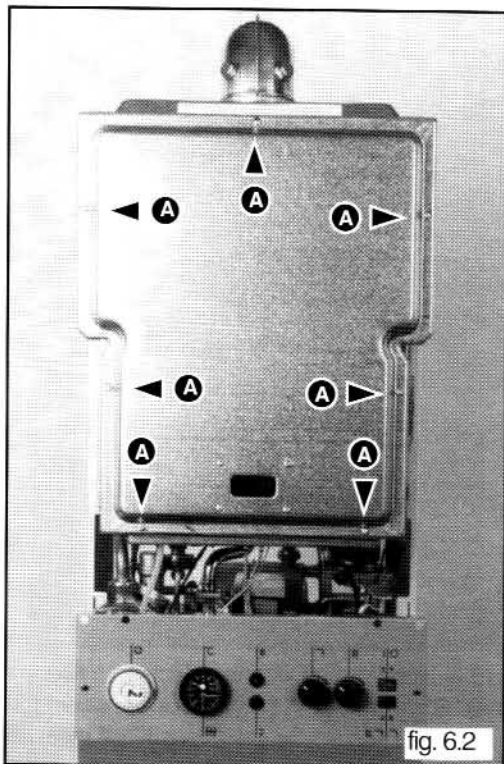

fig. 6.2

To remove the cover, remove screw A (see fig.6.2). Pull cover forward. When replacing cover ensure that the silicone seal is in good condition. If not replace the seal.

Opening combustion chamber

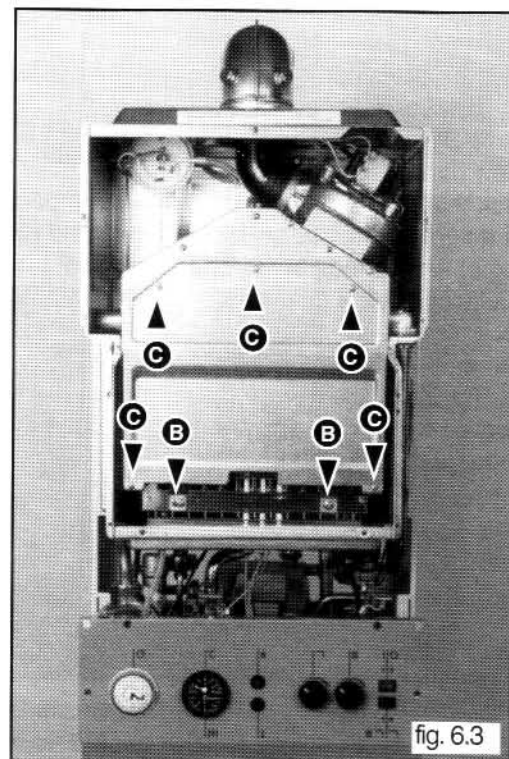

fig. 6.3

- 1 Remove screw B (see fig.6.3);
- 2 Remove screw C (see fig.6.3);
- 3 Pull forward and remove.

Servicing instructions

6.3 TO DRAIN THE MAIN CIRCUIT OF THE BOILER

- 1 Close c.h. flow and return cocks;
- 2 Release the manual vent cock (see fig.6.4);
- 3 Attach a small hose to the drainage cock "A" (see fig.6.5);
- 4 Open cock "A" and drain water from boiler.

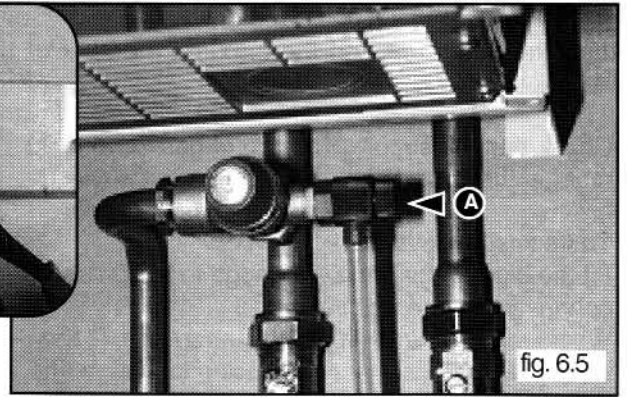

6.4 TO DRAIN THE D.H.W. CIRCUIT OF THE BOILER

- 1 Close the cold water inlet cock;
- 2 Attach a small hose to the drainage cock "B" (see fig.6.6);
- 3 Open cock "B" and drain water (see fig.6.6).

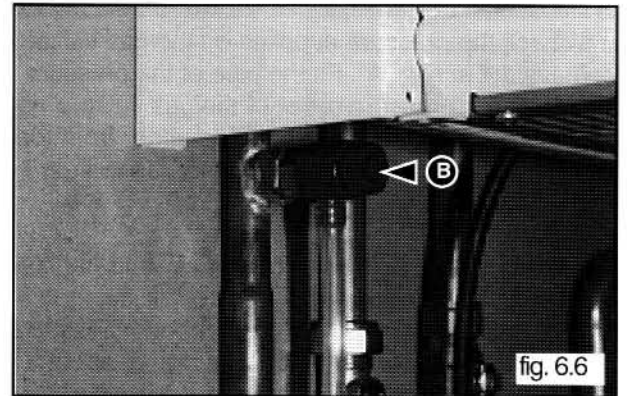

General information

6.5 SETTING GAS PRESSURES

Setting the minimum and the maximum power of the boiler (see fig.6.7)

- 1) Check that the supply pressure of gas valve is 20 mbar in the case of natural gas.
- 2) To do this, remove the screw "B".
Fit the pipe of the pressure gauge to the pressure connection of the gas valve.
When you have completed this operation, fit the screw "B" securely into its housing to seal off the gas.
- 3) To check the pressure supplied by the gas valve, remove the screw "A". Fit the pipe of the pressure gauge to the pressure outlet of the gas valve.
Disconnect the compensation pipe either from the gas valve or from the sealed chamber (see fig.6.7 a-b)
- 4) Set the ON/OFF switch to position <I> and the "summer/winter" switch to winter position III ↘.
To set the maximum power, turn on the hot water tap and allow hot water tap to run at a rate of about 8 litres/minute so that the main burner turns on.
Adjust screw "D" on the solenoid to set the pressure valve (displayed on the pressure gauge) corresponding to the maximum power (see table sect.1.2).

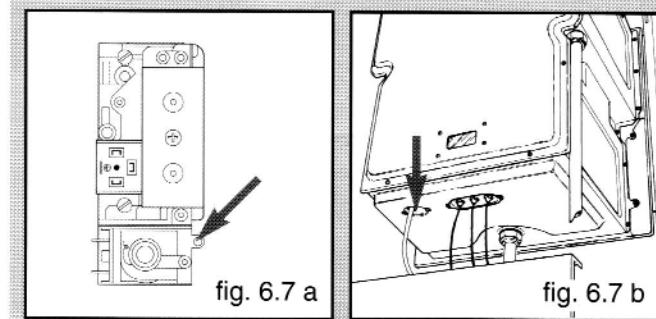
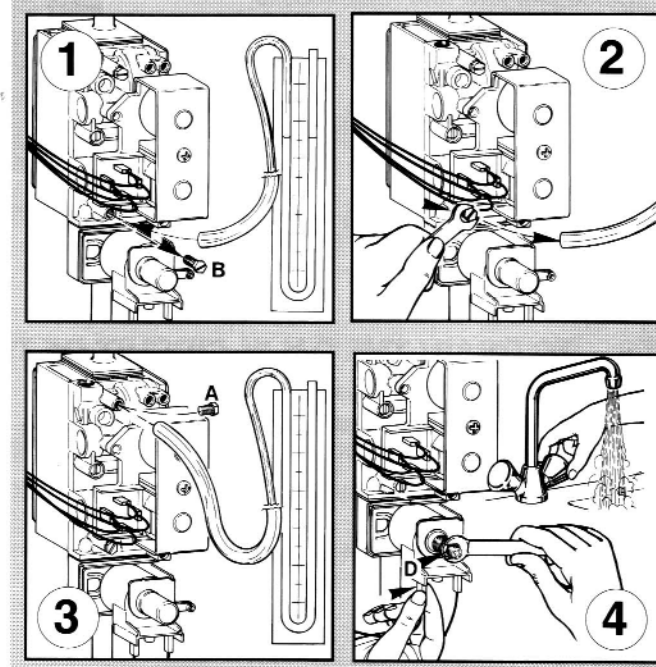

Servicing instructions

- 5) To set the minimum power, disconnect a supply terminal and adjust screw "C".
Turn the screw clockwise to increase the pressure and counter-clockwise to decrease the pressure (displayed on the pressure gauge) corresponding to the minimum power (see table sect.1.2).
- 6) When you have completed the above operations, turn off the hot water tap, re-connect the supply terminal to the solenoid on the gas valve and replace the cap on the screws of the solenoid.

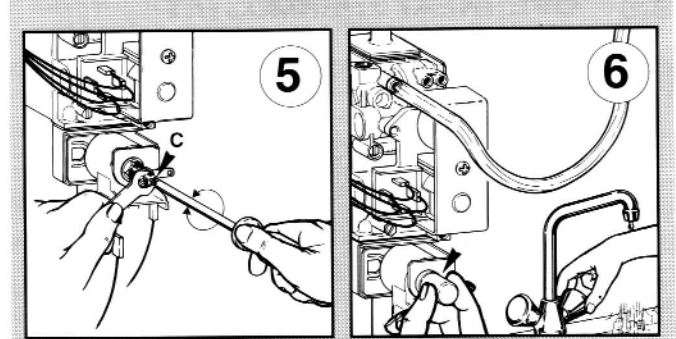

fig. 6.7

Setting the maximum heating circuit power (see fig. 6.8)

- 1) To set the maximum heating circuit power, place the ON/OFF switch to position <I> and the "summer/winter" switch to winter position III ↴ .
Turn the knob of the heating thermostat clockwise to maximum;
- 2) Remove the front cover of the boiler and find the electronic control unit, which is situated next the gas valve.
Fit a cross-head screw driver into the hole marked "Maximum heating circuit power regulation" through to the potentiometer. Turn clockwise to increase the pressure or counter-clockwise to reduce the pressure. Adjust the setting to the required heating pressure value (displayed on the pressure gauge), as indicated in the diagrams shown on page 57.
- 3) Turn off the boiler by placing the main switch of the boiler on "OFF".
- 4) Disconnect the detection electrode cable.
Turn on the boiler by placing the main switch to position "I" and sparks will come on.
Check the gas pressure on the pressure gauge which must be about 50 mm H₂O .

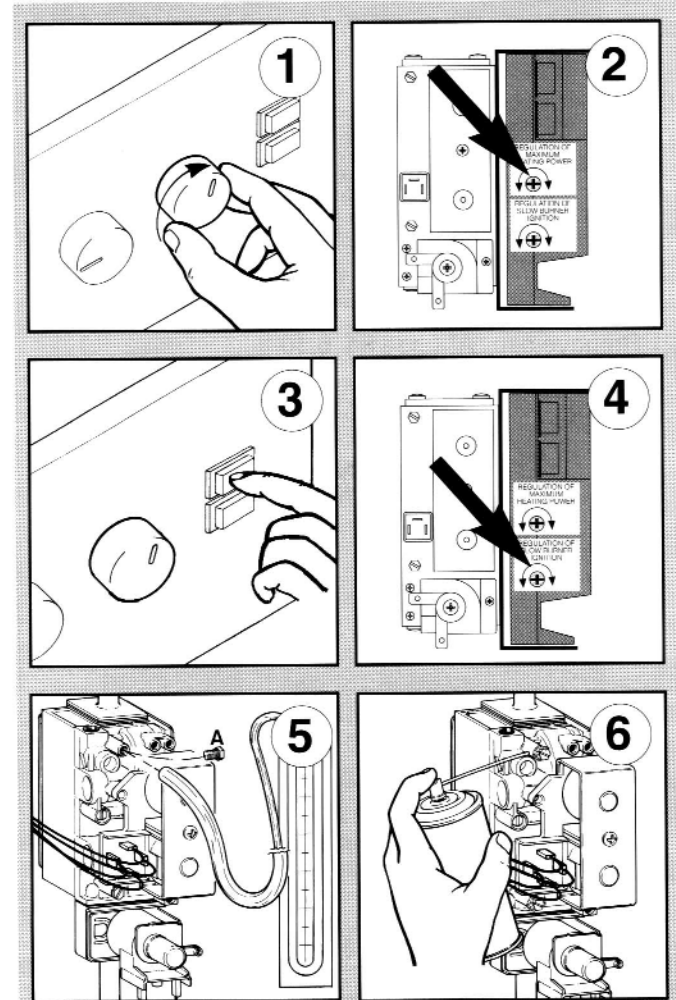

fig. 6.8

	NATURAL GAS (G20)	BUTANE GAS (G30)	PROPANE GAS (G31)
Recommended pressure for slow ignition	5 mbar - 1.95 in w.g.	18 mbar - 7.0 in w.g.	19 mbar - 7.4 in w.g.

If it is necessary adjust the slow ignition.
Fit a cross-head screw driver into the hole marked "REGULATION OF SLOW BURNER IGNITION" on the electronic P.C.B., through the potentiometer.

- 5) Remove the pipe of the pressure gauge and connect screw "A" to the pressure outlet in order to seal off the gas.
- 6) Carefully check the pressure outlets for gas leaks (valve inlet and outlet).

IMPORTANT!

Whenever you disassemble and reassemble the gas connections, always check for leaks using a soap and water solution.

Servicing instructions

6.6 OVERHEAT THERMOSTAT

1 Ensure electricity is switched off at main isolator;

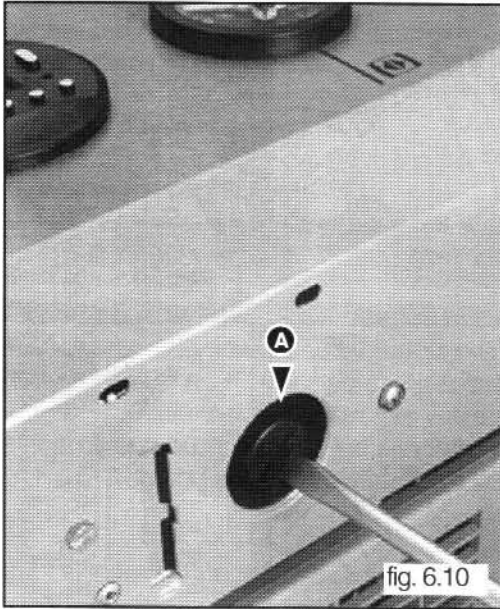

2 Remove cap "A" (see fig. 6.10);

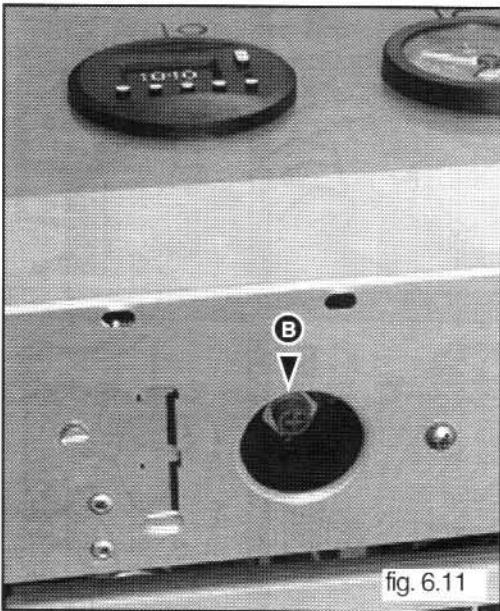

3 Remove the securing nut "B" (see fig. 6.11);

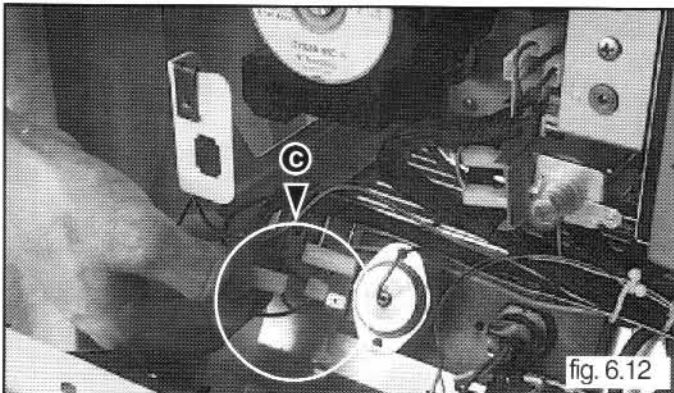

4 Lower control panel (sect. 6.2) and remove electrical connectors "C" (see fig. 6.12);

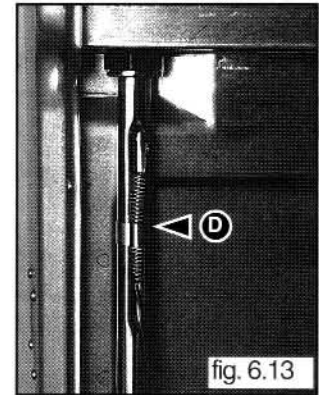

5 Remove spring "D" (see fig.6.13).

6 Reassemble in reverse order.

6.7 REMOVING IGNITION ELECTRODE

1 Ensure electricity is switched off at main isolator;

2 Lower control panel (sect. 6.2);

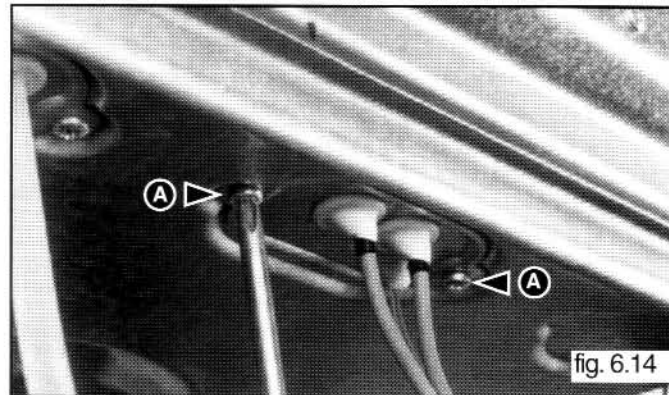

3 Remove screws "A" using a POZI-DRIVE No.2 star screw-driver(see fig. 6.14);

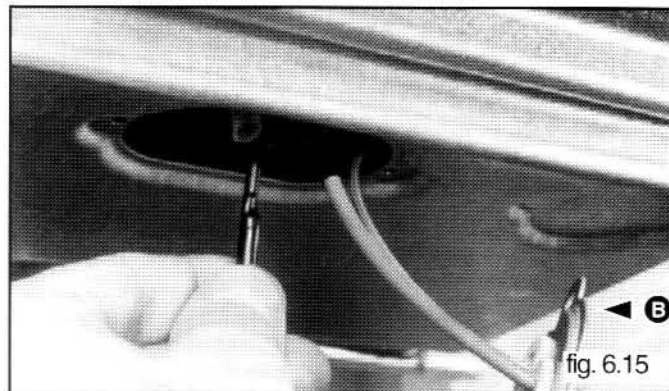

4 Slide the plate "B" and disconnect the cables pulling them downwards (see fig. 6.15);

Servicing instructions

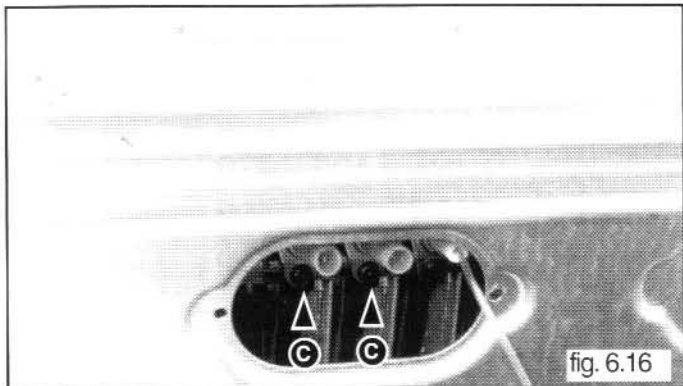

5 Remove screws "C" using a PHILLIPS No.2 star tip screwdriver (see fig. 6.16);

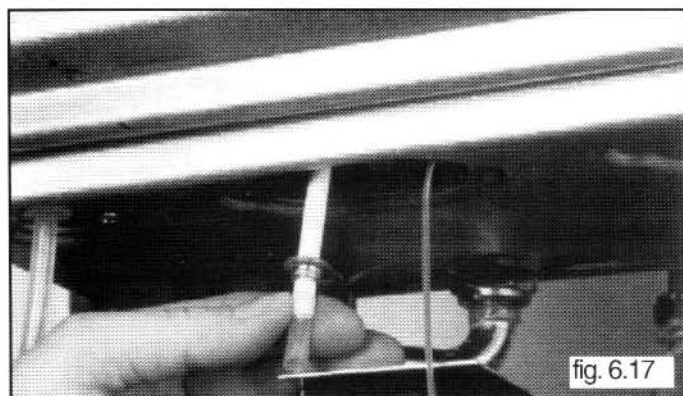

6 Slide the electrodes gently downwards (see fig. 6.17); To mount, repeat the steps in reverse order, paying particular attention to the following:

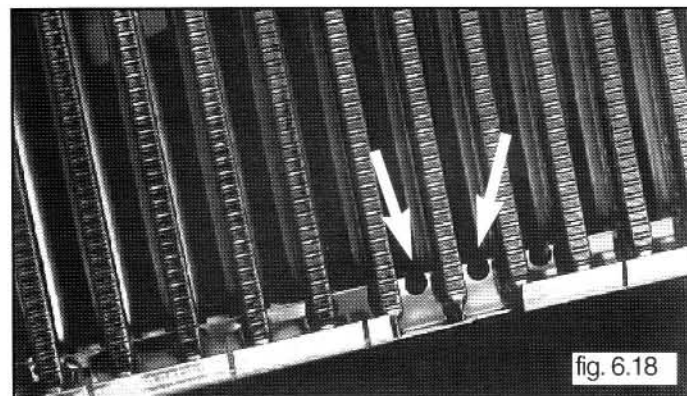

a Centre the second support hole which you will find between the connections, otherwise the electrode may break (see fig. 6.18);

b Check that the cables have in fact been connected, since friction and interference are often misleading;

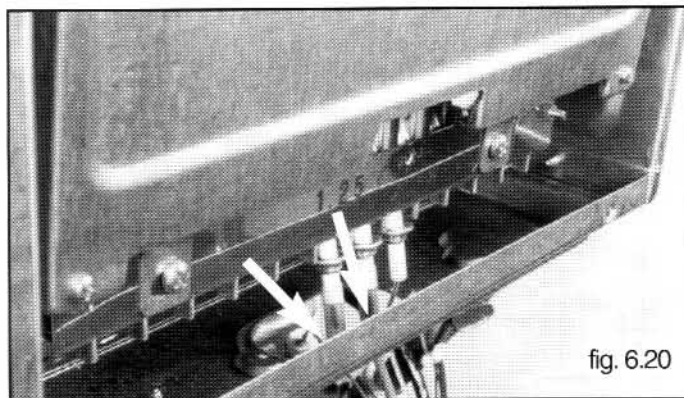

c Check that the transparent silicone pipe covers the cable-electrode connection point adequately (see fig. 6.20);

6.3 REMOVING FLAME SENSOR

(Detection electrode)

- 1 Ensure electricity is switched off at main isolator;
- 2 Lower control panel (sect. 6.2);
- 3 Remove screws "A" using a POZI-DRIVE No.2 star tip screw-driver(see fig. 6.14);
- 4 Slide plate "B" downwards (see fig. 6.15);
- 5 Remove the screw which fixes the sensor using a PHILLIPS No.2 star tip screwdriver (see fig. 6.21);

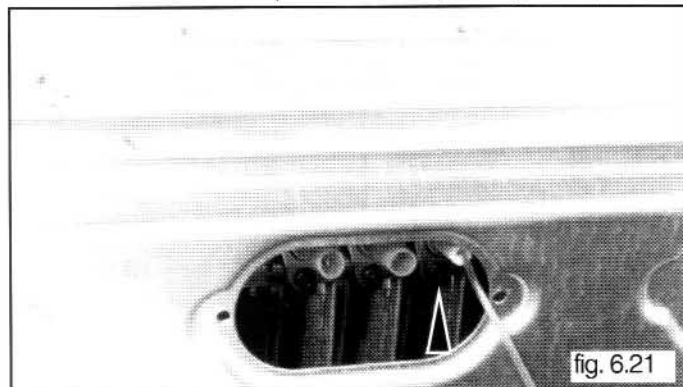

- 6 Slide the electrode downwards very gently;
- 7 Disconnect the cable at its only connection point close to the p.c.b.(see fig. 6.22);

When you reassemble the part, follow the steps in reverse order ensuring that you centre the second support hole between the connection, otherwise the electrode may break.

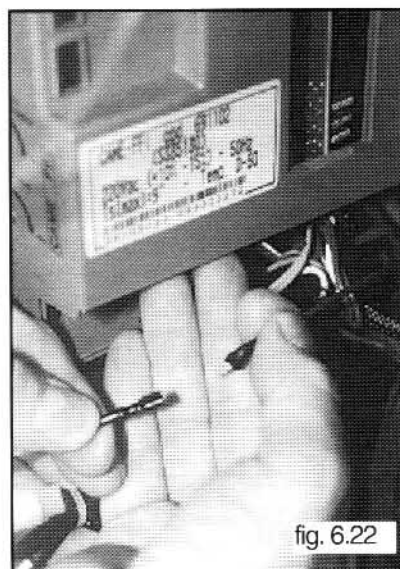

Servicing instructions

6.9 REMOVING D.H.W. THERMOSTAT

- 1 Ensure electricity is switched off at main isolator;
- 2 Drain down boiler (sect. 6.3);

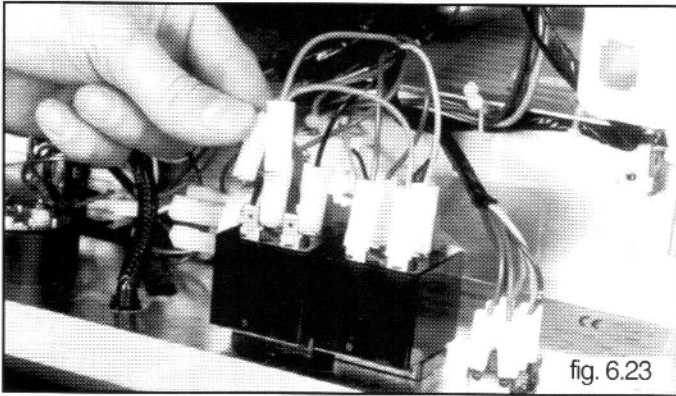

- 3 Disconnect the electric wires (see fig. 6.23);

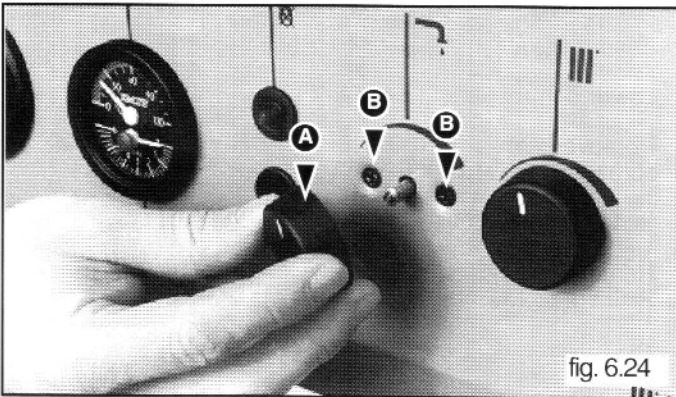

- 4 Remove knob "A" (see fig. 6.24);
- 5 Remove screws "B" using a PHILLIPS No.2 star tip screw-driver(see fig. 6.24);
- 6 Remove the clamps joining the thermostat capillary to other cables;

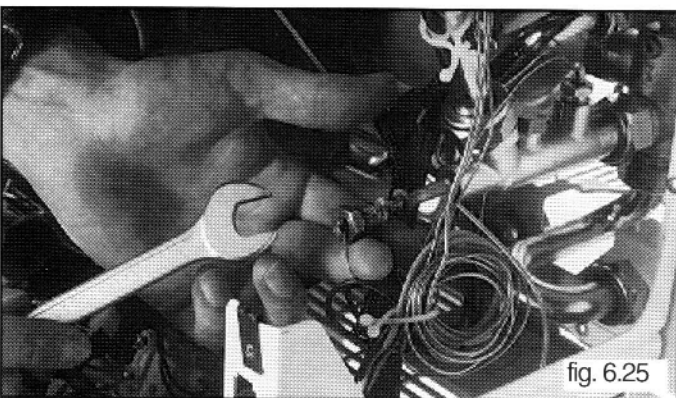

- 7 You will need a 14 mm open ended to rotate the

coupling which is part of the thermostat (see fig. 6.25).
Do not loose the thermostat gasket!!

To re-install follow the steps in reverse order.

6.10 BOILER THERMOSTAT

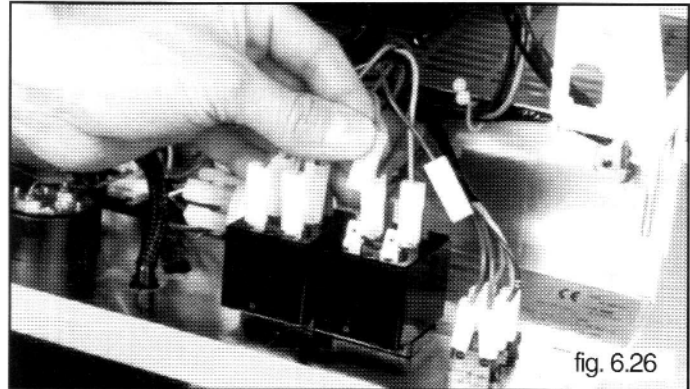

- 1 Ensure electricity is switched off at main isolator;
- 2 When disconnecting the cables, mark in reference points to help you reassemble the part without problems (see fig. 6.26

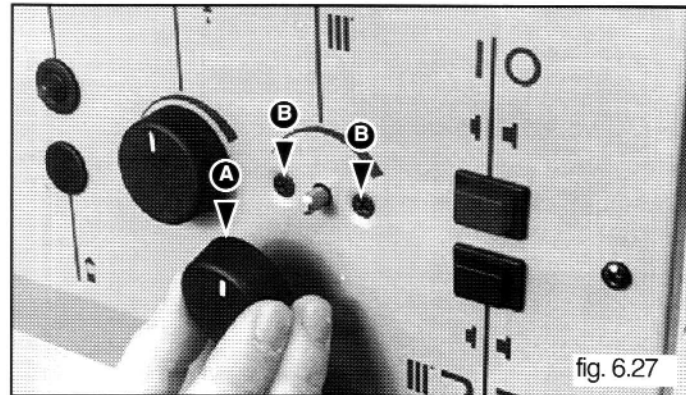

- 3 Remove knob "A" (see fig. 6.27);
- 4 Remove screws "B" using a PHILLIPS No.2 star tipped screw-driver (see fig. 6.27);
- 5 Remove the clamps which joins the capillary of the thermostat to the other cables;
- 6 Remove the proper spring and then the bulb* (see fig. 6.28);

Follow the steps in reverse order to reassemble, but be especially careful with the electrical connections because it is very easy to make a mistake.

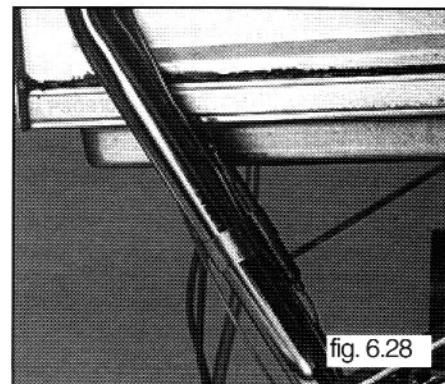

Servicing instructions

6.11 EMC FILTER (RADIO INTERFERENCE SUPPRESSOR)

- 1 Ensure electricity is switched off at main isolator;
- 2 Lower control panel;
- 3 Remove nut "A" by a "14 mm" open ended spanner (see fig. 6.29);

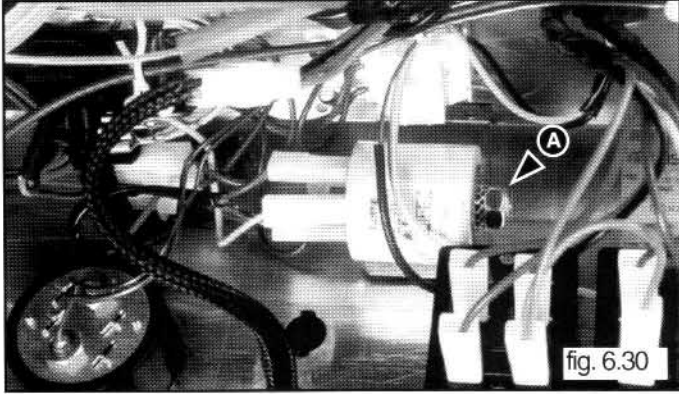

- 4 Disconnect electrical connections;
- 5 Reassemble in reverse order.

6.12 MICROSWITCHES ON DIVERTOR VALVE

- 1 Ensure electricity is switched off at main isolator;
- 2 Lower control panel (sect. 6.2);

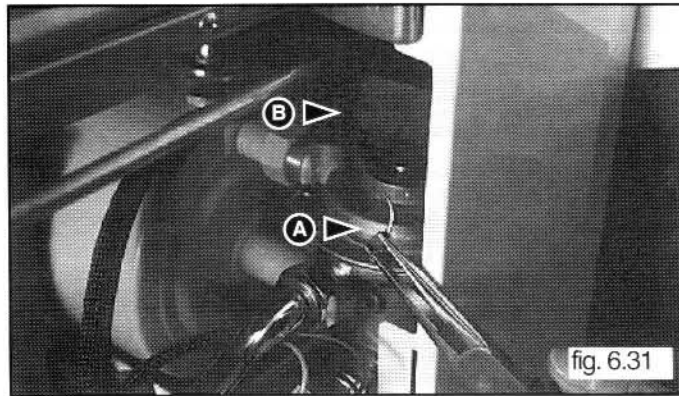

- 3 Remove retention clip A (see fig. 6.31);

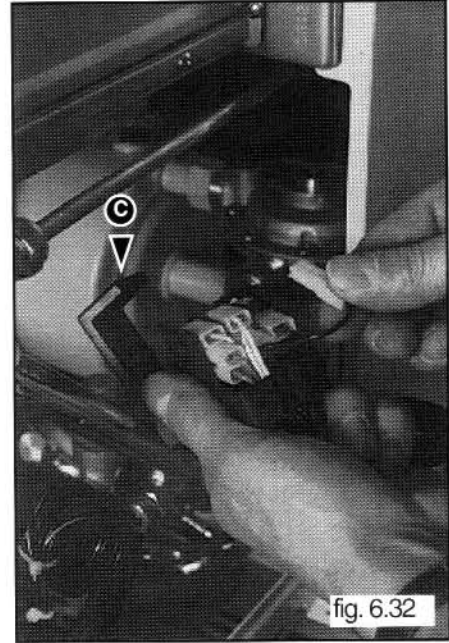

- 4 Lift and remove from valve (see fig. 6.32);
- 5 Remove cover B (see fig. 6.31);
- 6 When disconnecting electrical connection, mark in reference points to help you reassemble the part without problems;
- 7 Reassemble in reverse order.

6.13 BURNER and INJECTORS

- 1 Ensure electricity is switched off at main isolator;
- 2 Lower control panel (sect. 6.2);
- 3 Remove all electrodes (sect. 6.7 and 6.8);

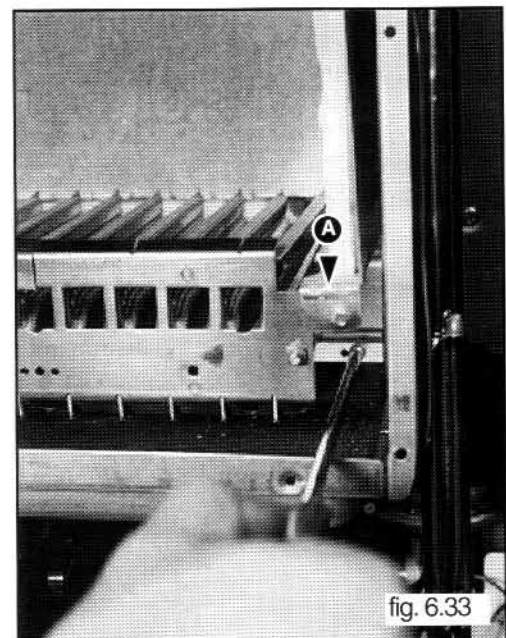

- 4 Remove the 4 screws "A" using a PHILLIPS No.2 star tip screw-driver (see fig. 6.33);

Servicing instructions

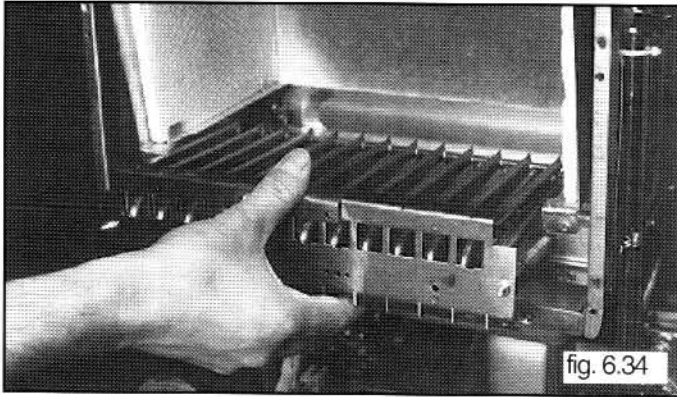

5 Remove the CONNECTION unit (see fig. 6.34);

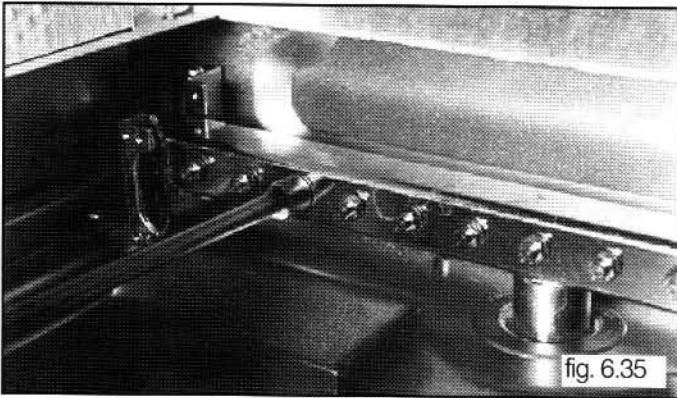

6 Remove the nozzles using a No.7 socket spanner. Keep the washers (see fig. 6.35);

Reassemble in reverse order.

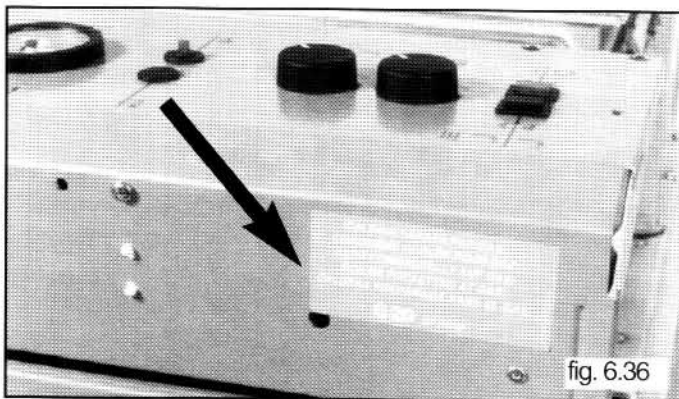

NOTE: When you are replacing the nozzles to convert the appliance for use with a different type of gas, remember to replace the existing data plate (under the instrument panel) by the plate supplied in the modification kit (see fig. 6.36) .

6.14 INSULATION PANELS

To replace the front insulation panel (see fig. 6.37)

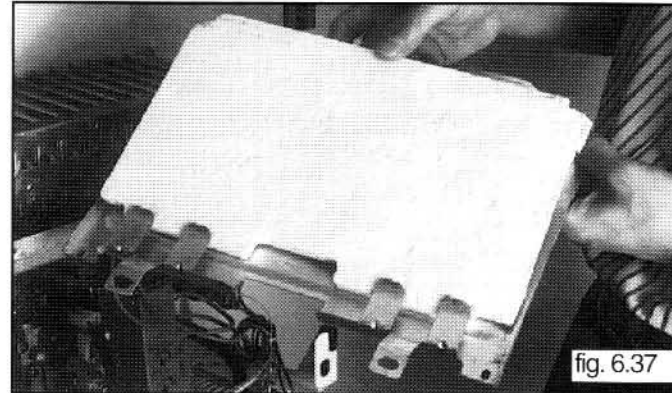

1 To remove the combustion chamber cover (sect. 6.2) hold the panel firmly and pull downwards. No other tool is required.

To replace the side insulation panel (see fig. 6.38)

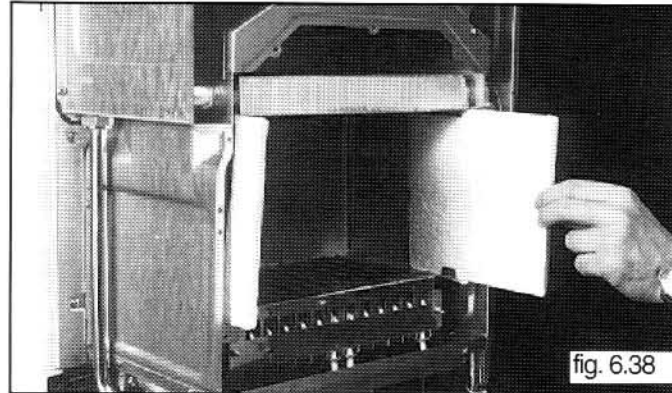

1 Remove the combustion chamber cover (sect. 6.2);
2 Slide the side insulation panels forward;
3 Replace in reverse order.

To replace the back insulation panel

1 Remove the combustion chamber cover (sect. 6.2);
2 Dismount the hood together with the fan (sect. 6.19);
3 Dismount the primary exchanger (sect. 6.21);
4 Pull the panel up and slide it out;
5 Reassemble in reverse order.

6.15 GAS MODULATOR CARTRIDGE

1 Ensure electricity is switched off at main isolator;
2 Lower control panel (sect. 6.2);

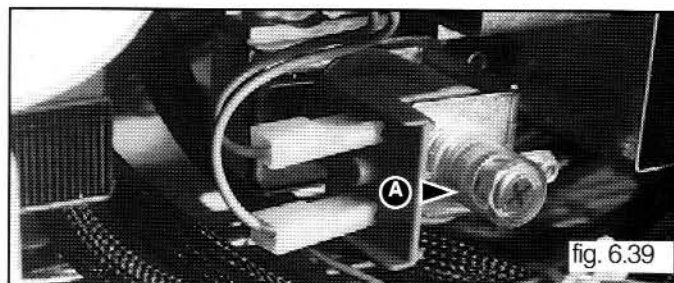

3 Turn the protection cap "A" and remove it from the adjustment control. Use a flat-edge screw driver to help

Servicing instructions

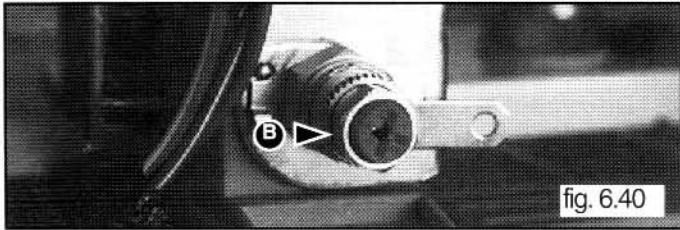

- 4 With a 14 mm spanner turn the cartridge "B" counter-clockwise (see fig. 6.40);

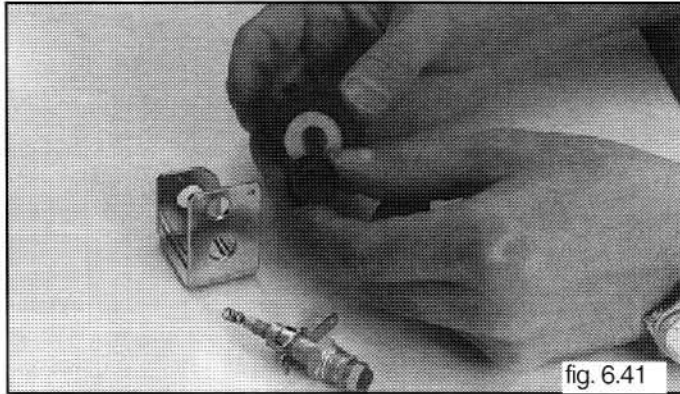

- 5 Remove the cartridge, but be very careful not to loose the internal components (see fig. 6.41);
- 6 Reassemble in reverse order.

6.16 GAS MODULATOR COIL

- 1 Ensure electricity is switched off at main isolator;
- 2 Disconnect the two cables;
- 3 Lower the control panel (sect. 6.2);
- 4 Remove the gas modulator cartridge as explained in

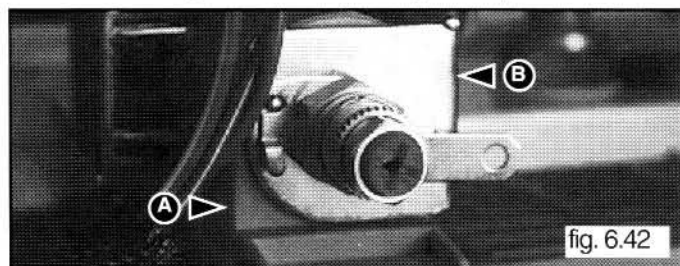

- sect.6.16;
- 5 Slide the coil "A" and its housing from the valve (see fig. 6.42);

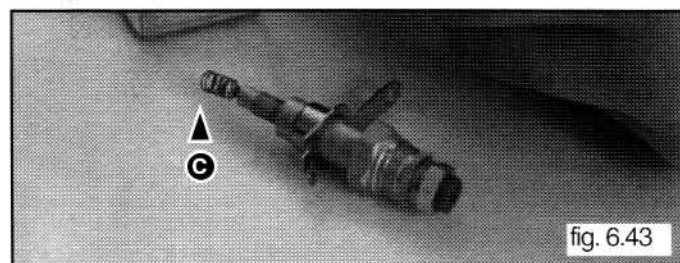

- 6 Remove the plate "B" (see fig. 6.42);
- 7 Slide the coil from its housing, being very careful not to

6.17 ON-OFF OPERATOR COILS

- 1 Ensure electricity is switched off at main isolator;
- 2 Lower the control panel (sect. 6.2);

To remove the TANDEM operator coil

- 3 Disconnect the cables "B" (see fig. 6.45);
- 4 Unscrew the screw "A" and slide the TANDEM coils with its housing from the valve (see fig. 6.45);
- 5 Reassemble in reverse order.

6.18 GAS VALVE

- 1 Ensure electricity is switched off at main isolator;
- 2 Remove the cover and lower the instrument panel (sect. 6.2);
- 3 Disconnect all the cables "B"(see fig. 6.45);
- 4 Remove the bottom plastic grid.
- 5 Remove the four screws "D" (see fig. 6.46);
- 6 Release the top nut "C" using a 30 mm open ended spanner (see fig. 6.44);
- 7 Reassemble in reverse order.

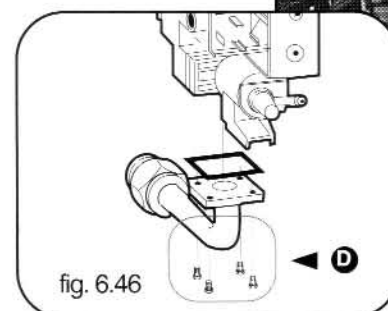
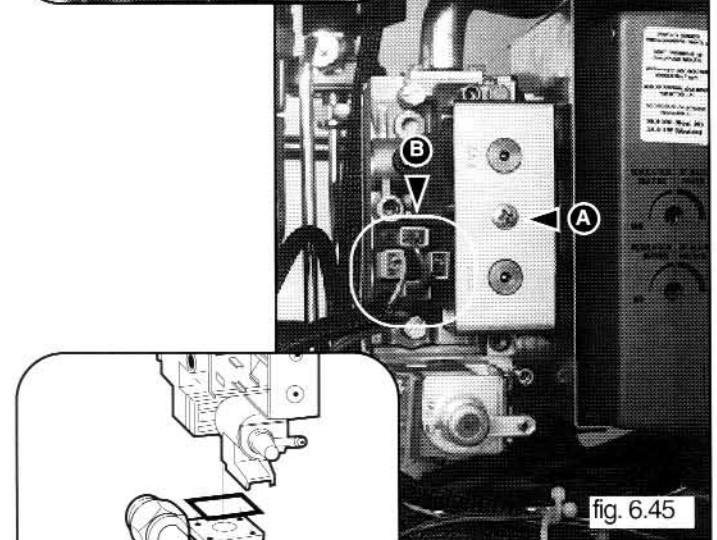
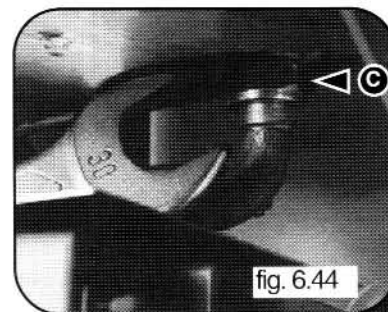

Servicing instructions

6.19 REMOVING THE FAN

- 1 Ensure electricity is switched off at main isolator;
- 2 Remove sealed chamber cover (sect. 6.2);

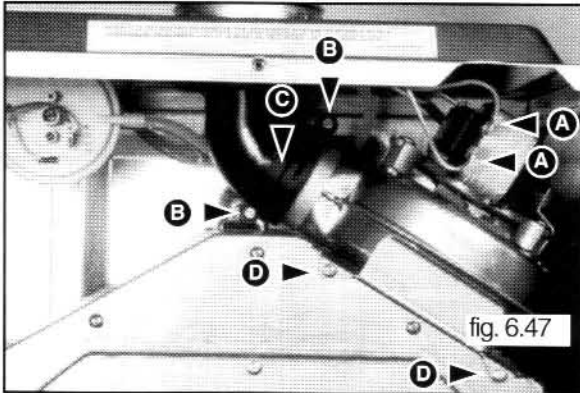

- 3 Disconnect electrical connections "A" (see fig. 6.47);
- 4 Remove screws "B" using a flat tip screw-driver with a tip of at least 6.5 mm (see fig. 6.47);
- 5 Remove clamp "C" (see fig. 6.47);
- 6 Remove screws "D" (see fig.6.47);

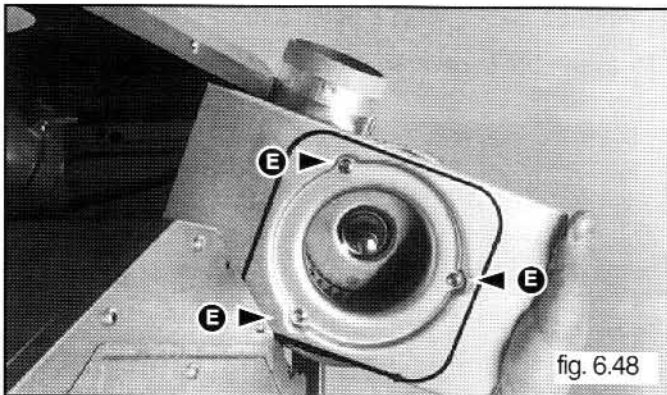

- 7 Pull fan forward and remove;
- 8 Remove screws "E" using a POZI-DRIVE No.2 star tip screw-driver (see fig. 6.48);
- 9 Remove fan from mounting plate;
- 10 Reassemble in reverse order.

Ensure that the silicone seal is in good order.
If necessary replace the seal.

6.20 AIR PRESSURE SWITCH

- 1 Ensure electricity is switched off at main isolator;
- 2 Disconnect every electrical connections (A;B;C) (see fig. 6.49);

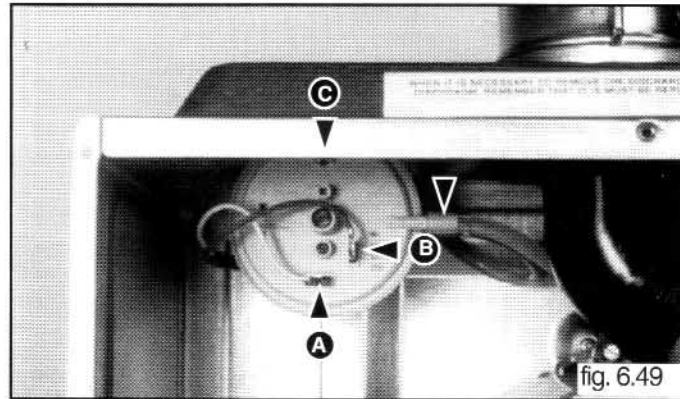

- 3 Disconnect silicon pipes at connection point as shown by arrow on fig. 6.49;
- 4 Remove screws D on the top of the sealed chamber as shown on fig. 6.50;
Use a n°2 star tip screw driver

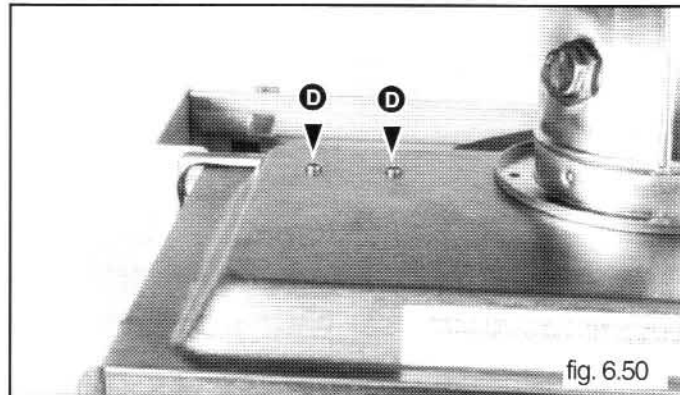

- 5 Remove screws which fix the air pressure switch to its support plate by a n°2 star tip screw driver (see fig.6.51)



REASSEMBLE IN REVERSE ORDER

WARNING!

Every type of A.P. switch has its own screws.
Different screws could compromise their normal operating.

Servicing instructions

6.21 MAIN HEAT EXCHANGER

- 1 Ensure electricity is switched off at main isolator;
- 2 Drain boiler (sect. 6.3);
- 3 Remove sealed chamber cover and open the combustion chamber (sect. 6.2);

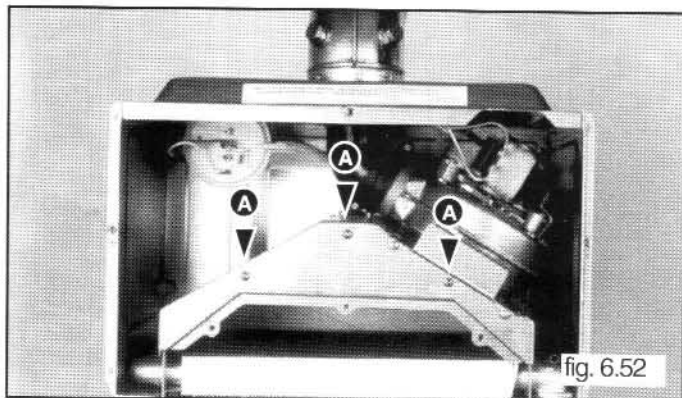

- 4 To remove the front panel of the flue hood, unscrew the 3 screws "A" using a POZI-DRIVE No.2 star tip screwdriver (see fig. 6.52);

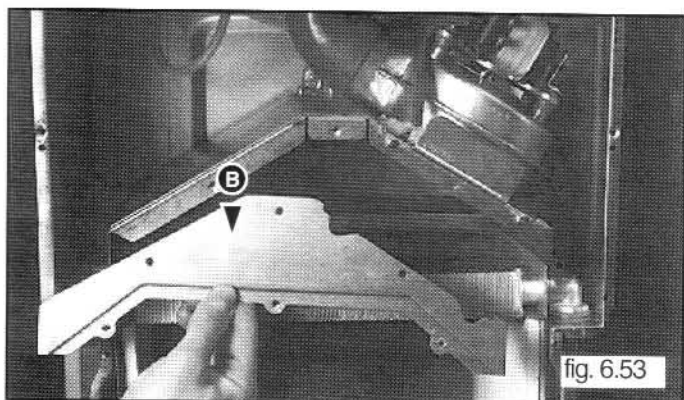

- 5 Remove the front panel of the hood "B" (see fig. 6.53);

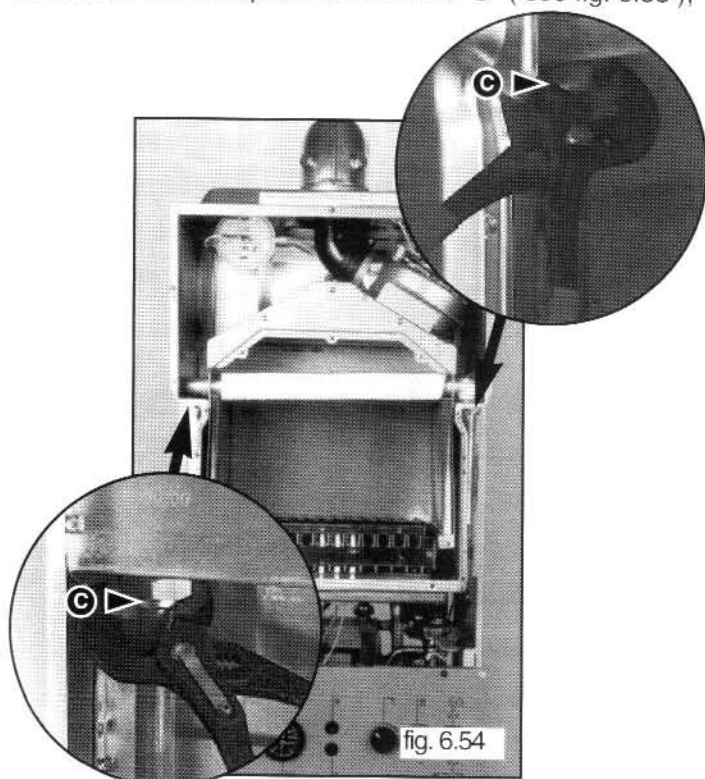

- 6 Release nuts "C" (see fig. 6.54);

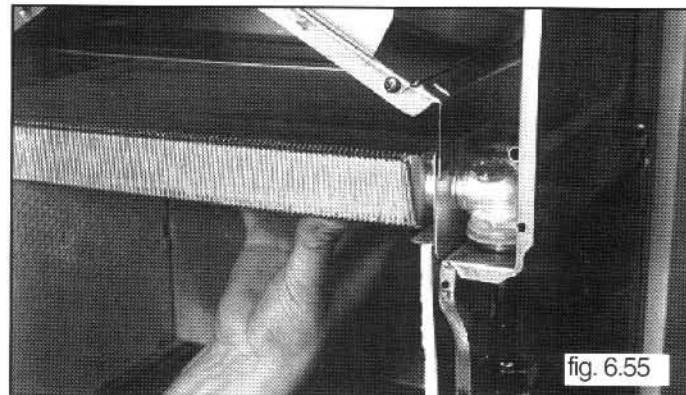

- 7 Lift the exchanger in order to release the attachments from their housing (see fig. 6.55);

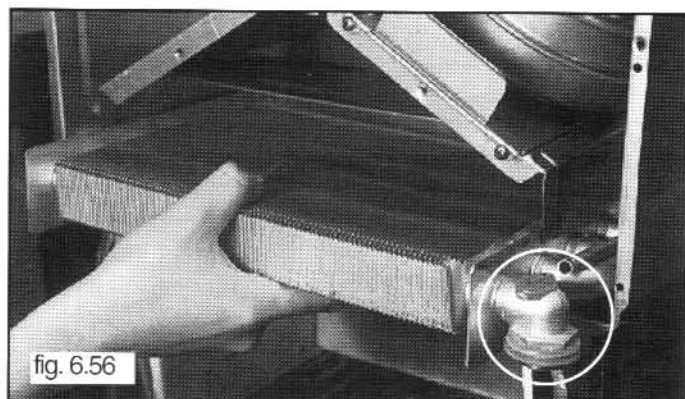

- 8 Pull it straight out (see fig. 6.56);
- 9 Keep the gaskets (see fig. 6.56).

Reassemble in reverse order.

6.22 AUTOMATIC AIR PURGER

- 1 Ensure electricity is switched off at main isolator;
- 2 Drain boiler (sect. 6.3);
- 3 Unscrew valve "A" (see fig. 6.57);
- 4 Reassemble in reverse order.

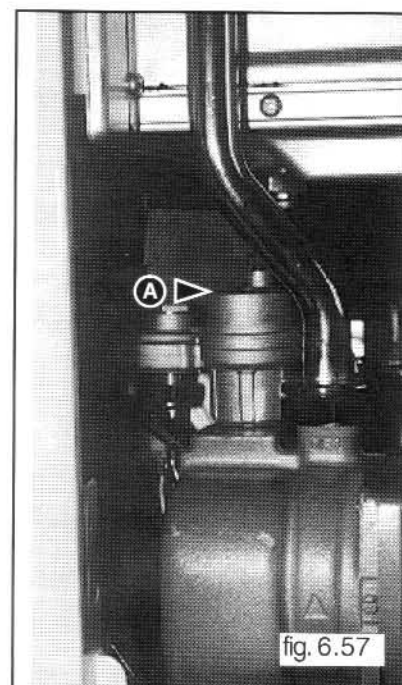

Servicing instructions

6.23 PUMP

- 1 Ensure electricity is switched off at main isolator;
- 2 Drain boiler (sect. 6.3);

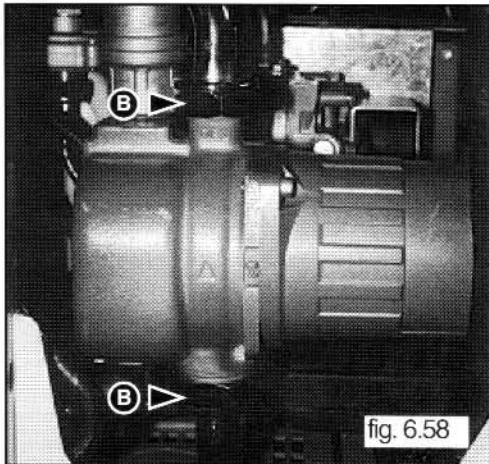

- 3 Release nuts "B" using a 36 mm open ended (see fig.6.58);

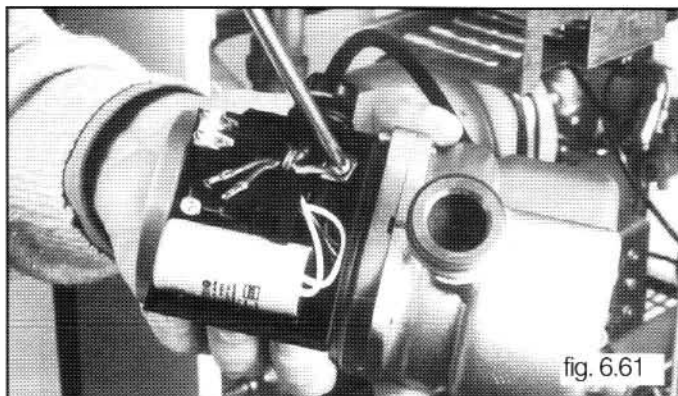
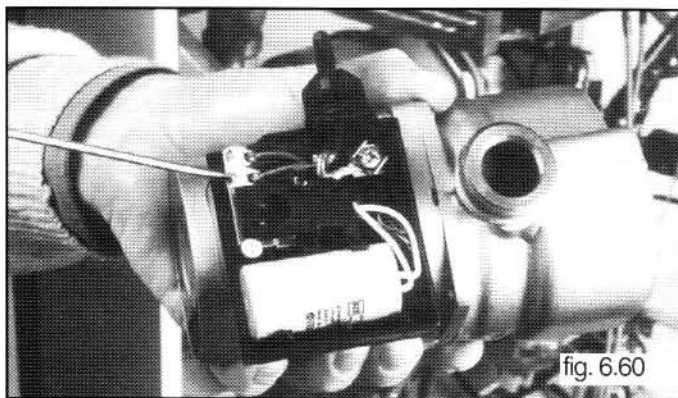
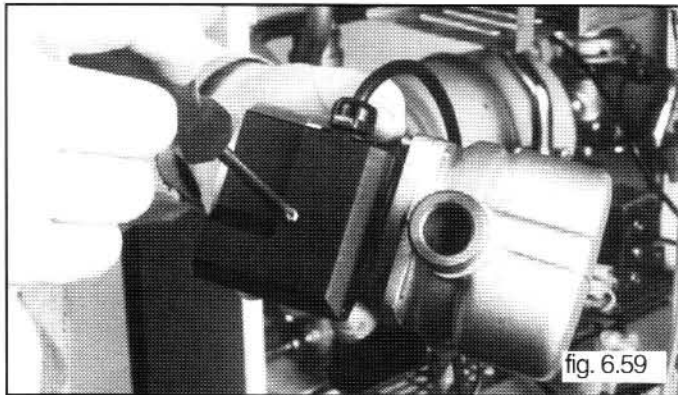

- 4 Disconnect electrical connections (see fig. 6.59, 6.60, 6.61).

6.24 PUMP PRESSURE SWITCH

- 1 Ensure electricity is switched off at main isolator;
- 2 Disconnect electrical wires (see fig. 6.62);

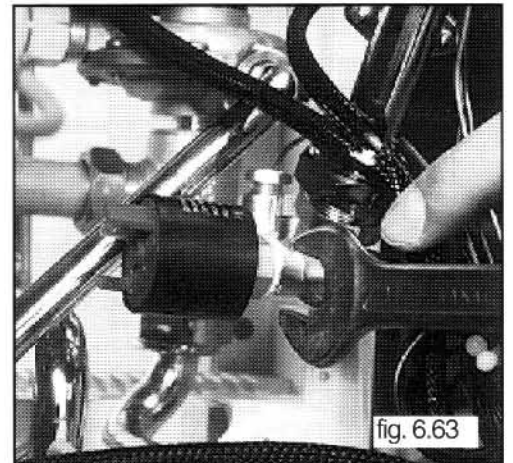
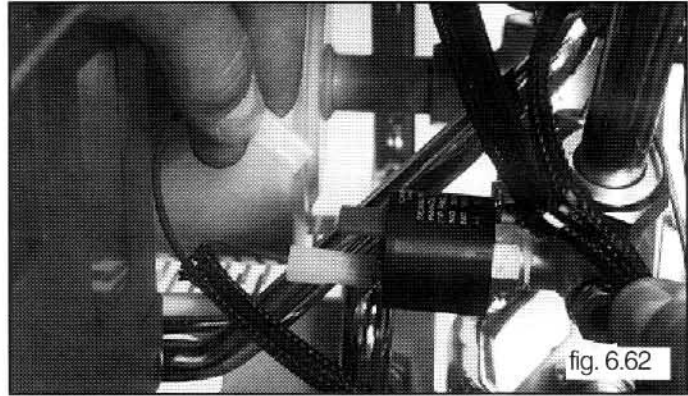

- 3 Remove pump pressure switch using a 17mm open ended (see fig.6.63);

6.25 MAIN CIRCUIT FLOW SWITCH

- 1 Ensure electricity is switched off at main isolator;
- 2 Drain boiler (sect. 6.3);
- 3 Disconnect electrical connectors "A" (see fig.6.64);
- 4 Release nuts "B" using a 17 mm open ended (see fig. 6.65);
- 5 Reassemble in reverse order.

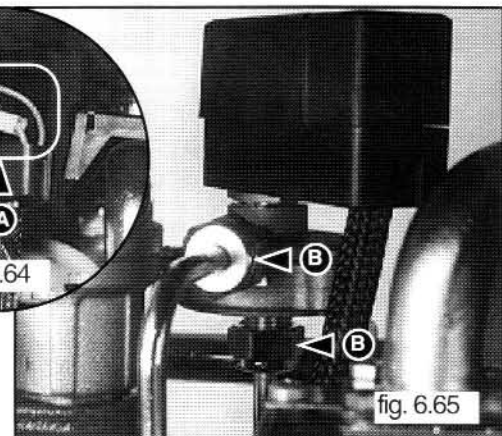

Servicing instructions

6.26 TEMPERATURE PRESSURE GAUGE

- 1 Ensure electricity is switched off at main isolator;
- 2 Remove the cover and lower the control panel (sect. 6.2);

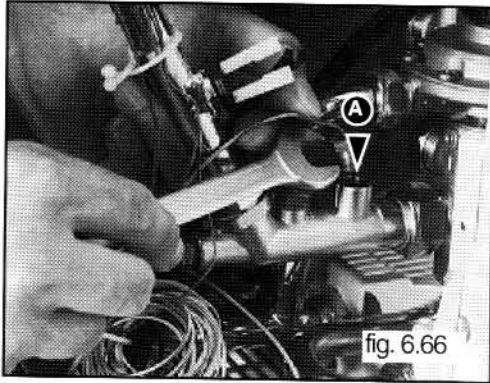

- 3 Drain boiler (sect. 6.3);
- 4 Release coupling "A" using a 14 mm open ended (see

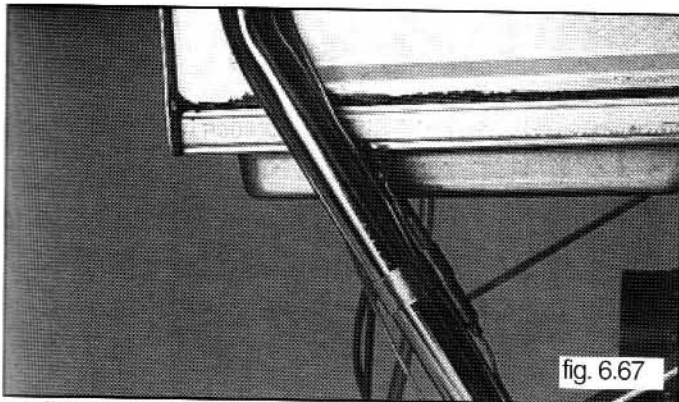
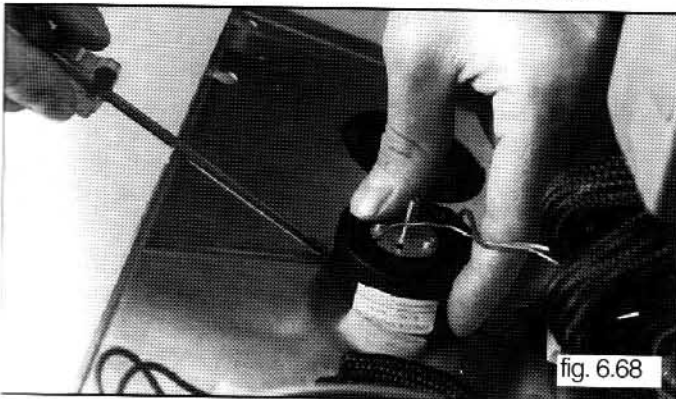

fig. 6.66);

- 5 Remove the clamps joining the capillary to the electric cables;
- 6 Remove the split pin and than bulb by pulling it



downwards (see fig. 6.67);

- 7 Push on the instrument from the interior to the exterior (see fig. 6.68);
- 8 Reassemble in reverse order.

6.27 REMOVING DIVERTOR VALVE

- 1 Ensure electricity is switched off at main isolator;
- 2 Shut the mains wastestop cock;
- 3 Drain boiler (sect. 6.3);
- 4 Drain d.h.w. section (sect. 6.4);
- 5 Dismount the microswitches as shown in sect. 6.12;
- 6 Release all the coupling nuts using a 20, a 30 and a 36 mm open ended (see fig. 6.69);

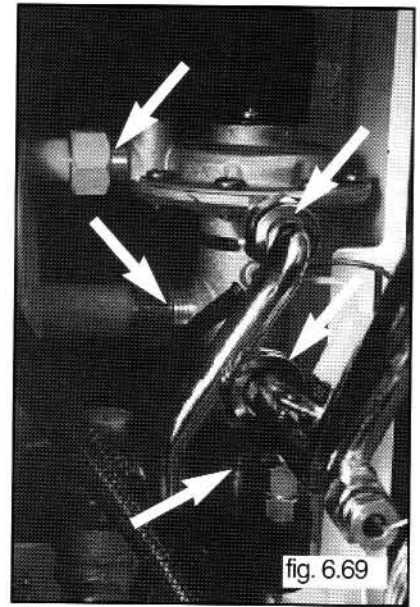

- 7 Reassemble in reverse order.

Ensure that the flat packing is in the correct position.

6.28 SECONDARY EXCHANGER

- 1 Ensure electricity is switched off at main isolator;
- 2 Drain boiler (sect. 6.3);
- 3 Drain d.h.w. section (sect. 6.4);
- 4 Remove the gas valve (sect. 6.18);
- 5 Release all the nuts as shown in figures 6.70 & 6.71 , using a 24 and a 36 mm open ended;
- 6 Only for models "20" attention to do not lose the diaphragm placed under nut B!!
- 7 Remove exchanger vessel through the front of the boiler;

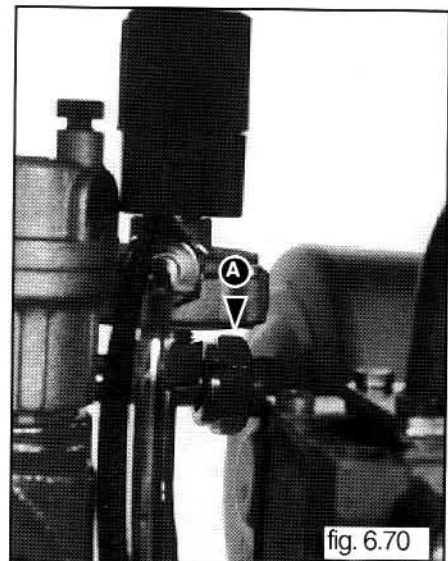

Servicing instructions

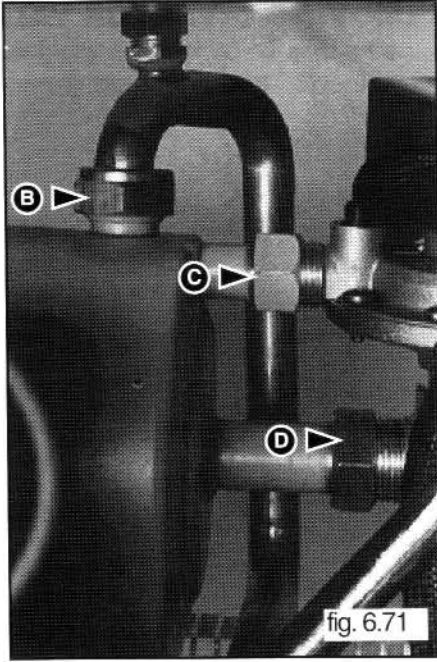

8 Reassemble in reverse order.

6.29 EXPANSION VESSEL

- 1 Ensure electricity is switched off at main isolator;
- 2 Drain boiler (sect. 6.3);
- 3 Remove nut "A" away from the expansion vessel using a

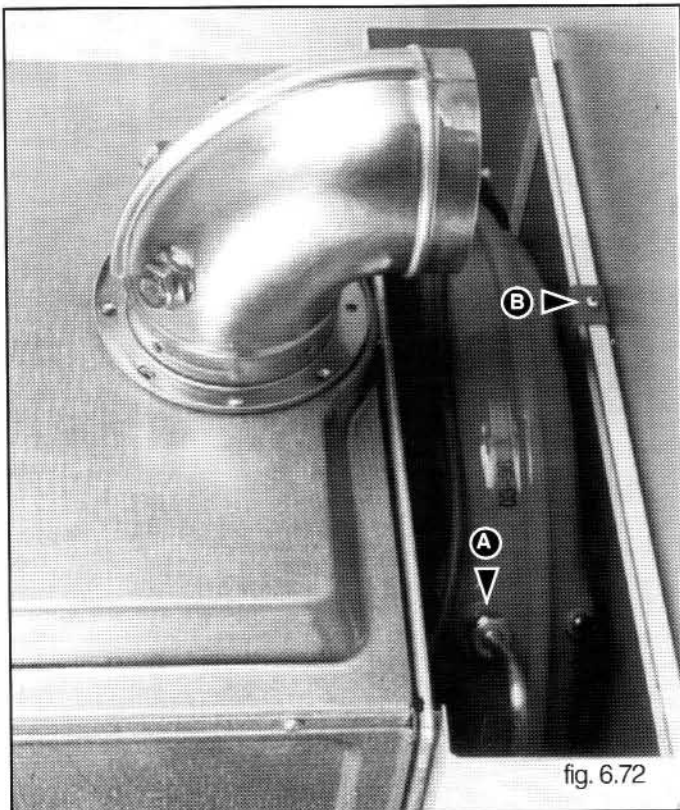

4 Remove screw "B" using a POZI-DRIVE No.2 star tip screw driver (see fig. 6.72);

5 Lift expansion vessel up from the boiler;

6 Reassemble in reverse order.

If there is not adequate clearance the boiler must be removed from the wall before the removal procedure can be carried out.

6.30 SAFETY VALVE

- 1 Ensure electricity is switched off at main isolator;
- 2 Drain main system (sect. 6.3);
- 3 Loosen nut "A" (see fig. 6.73);
- 4 Loosen nut "B" (see fig. 6.73);
- 5 Remove valve;
- 6 Reassemble in reverse order

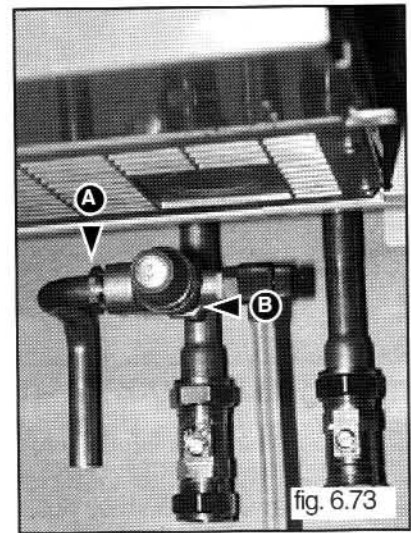

7 FAULT FINDING

7.1 TOTAL CHECK SYSTEM (TCS)

The TOTAL CHECK SYSTEM (which will be referred to as "TCS") is designed to locate faults quickly and easily. The TCS tests GOVE2-CAME and CAME/ES type electronic PCBs (see fig.7.1).

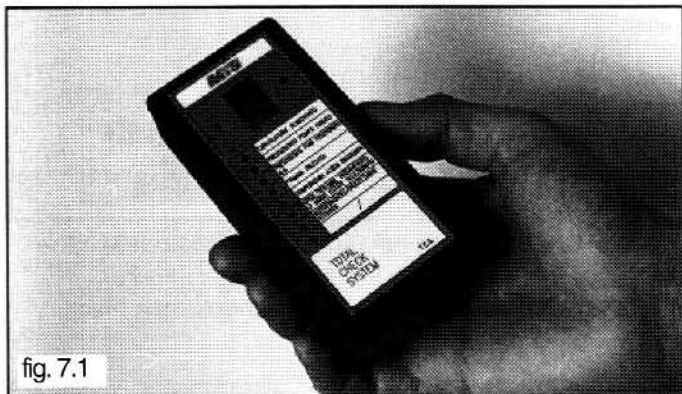

fig. 7.1

This device makes it possible to check the proper functioning of the electronic PCBs and components these control, it is connected to the PCB via the cable which you will see is folded back inside the TCS.

The TCS indicates:

- The actual state of the boiler;
- The eventual fault.

The informations given by the TCS are as follows (see fig.7.2):

a) n°2 LEDS EACH SIDE OF THE DIASPLAY:

- green LED : the boiler work properly;
- red LED : the boiler has a fault.

b) DISPLAY SHOWING :

- the actual state of the boiler according to the following

numbers:

- "0" Boiler off
- "1" Autodiagnostic state
- "2" Spark ignition stage
- "3" Boiler functioning normally
- "4" Lockout
- "5" Boiler thermostat satisfied
- "6" Room thermostat/clock no demand or selector in summer setting

- the actual faults according to the following letters:

- "A" Faulty ventilation system
- "B" Air pressure switch stuck in N.O. position
- "C" Faulty reset switch
- "D" N.A.
- "E" Faulty flame detection
- "F" N.A.
- "G" N.A.

c) n°8 YELLOW LEDS UNDER THE DISPLAY :

- led 1 : Pump working (N.A. for this model)
- led 2 : Main flow switch closed (N.A. for this model)
- led 3 : Air pressure switch N.O.
- led 4 : Flame detected
- led 5 : Water at required temperature
- led 6 : Room thermostat/clock no demand or selector in summer setting
- led 7 : Autodiagnosics faulty

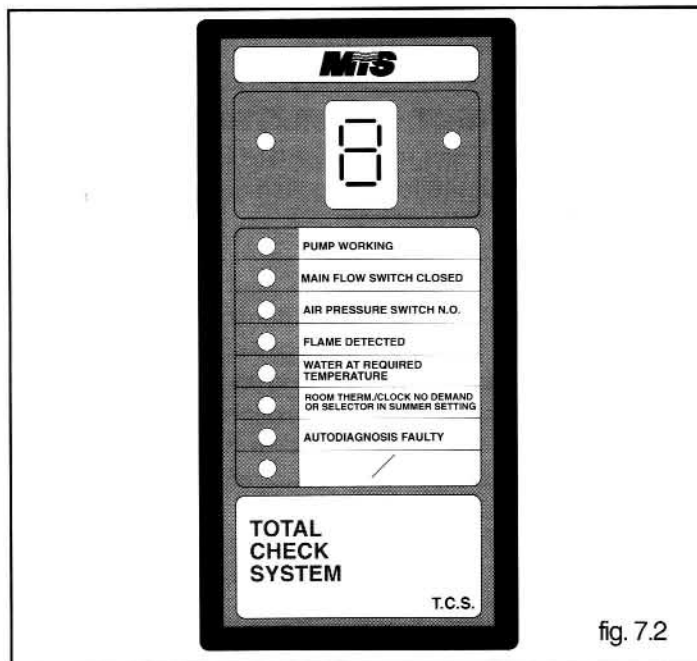

fig. 7.2

Note: During the operation of the TCS, faults may be signaled by the red LED and a letter in the display for short periods (one second or less), this is normal and does not signify these faults.

7.2 SPECIAL DEFECTS

There are special defects that can not been indicated by the TCS; these defects are treated in the following sections:

- Water leaks;
- Difficulty in lighting gas;
- Incorrect combustion;
- Traces of gas or exhaust gases in the installation area.

7.2.1 WATER LEAKS

Leaks from connectors, O-Rings or gaskets

Make sure that the surfaces which come into contact with the gaskets are free from dirt, roughness or deformation. Then substitute the gasket (both O-rings and flat gaskets).

Water leaks from safety valve

This may be caused by leaks from the d.h.w. over-pressurizing the heating circuit.

In this case remove the d.h.w. heat exchanger and replace it.

If the leak only occurs when the appliance is operating, empty the main water circuit and check the pressure applied to expansion vessel (1.2 bar).

7.2.2 DIFFICULTY IN LIGHTING THE BURNER

Make sure that input and output pressures on the gas valve are set to the correct values.

Also, make sure that no pressure variations are being caused by a malfunctioning component (defective pressure reducers or regulator; dirty gas filters; other gas consuming equipment installed on the same gas line, etc.).

Fault finding

Make sure that the ignition electrodes are positioned correctly.
Make sure that injectors are clean.

7.2.3 INCORRECT COMBUSTION

Make sure that the gas modulator has been set correctly and make sure that the following elements are clean:

- Burner;
- Combustion chamber;
- Flue system.

Make sure that the exhaust flue does not return to the appliance through the air intake duct.

Make sure that the flue terminal on the exhaust system has been installed in the correct position (see sect 3.4).

If extension flue have been used in the exhaust duct, make sure that these flue have been inserted correctly.

Please ensure that flue length does not exceed the maximum allowed (*consult special manual*).

Type c boiler installation instructions for air and flue exhaust pipes.

7.2.4 TRACES OF GAS OR EXHAUST FLUES

If gas is detected in the installation area, use a soap solution or a specific leak-detection product to make sure that all the gas connectors in the system are perfectly sealed.

Check for leaks when the appliance is shut down and during operation.

If exhaust fumes are detected in the installation area, make sure that the exhaust duct has been built to the exact

specifications prescribed. Also, check the exhaust duct for leaks and make sure that it is clean. Make sure that all exhaust duct-work conforms to current technical standards.

7.3 INSTALLATION OF THE TCS

- 1 Remove the boiler casing and lower the control panel as described in paragraph 6.2;

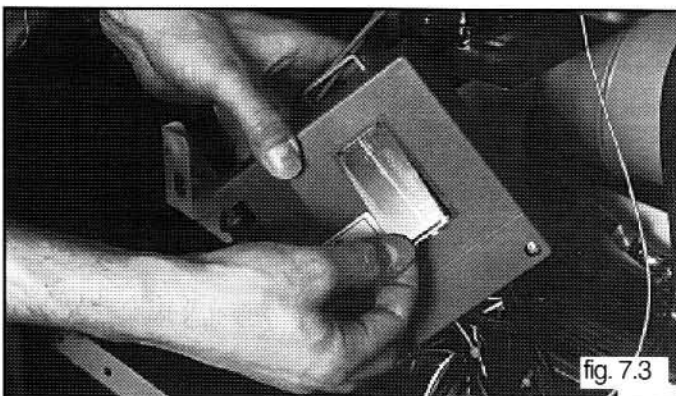

- 2 To remove the electronic PCB from its clamp, lift and then rotate it then remove the cover of pcb (fig.7.3);

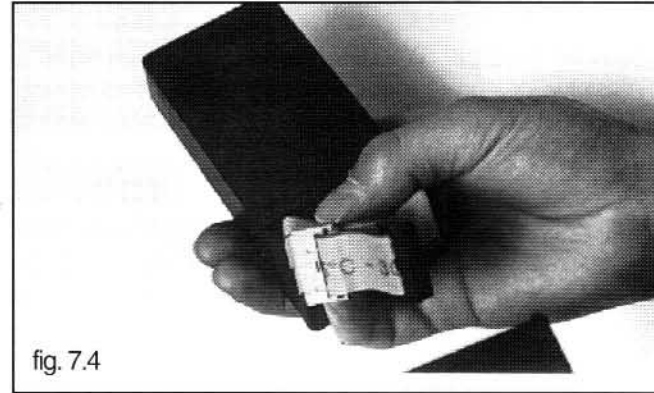

- 3 Remove the cover at the back in order to release the cable of the TCS.
You will see that there are two connectors: a black one

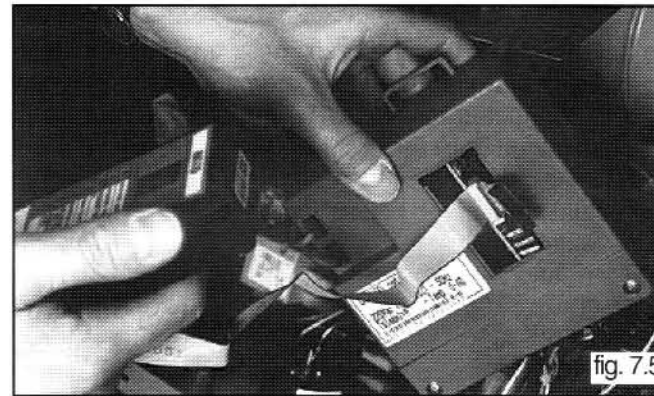

- and a grey one (see fig.7.4).
- 4 Connect the grey connector to the electronic PCB (see fig.7.5).

With the boiler switch set to ON, once you have made above connections, all the LEDs will light up and number 8 will flash on the display for one second; this means that the TCS is ready for use.

7.4 FAULT FINDING

The TCS gives information as to whether the boiler is faulty or is running properly.

According to the signals of the TCS, some verifications must be made and then the faults can be removed.

Follows the fault flow chart and the relative verifications according to the TCS state.

If the TCS is not available or is damaged, please follow the sequence as described at par. 7.5.

Fault finding

TCS STATE : All lights in the TCS are off while the main switch is on position "ON"

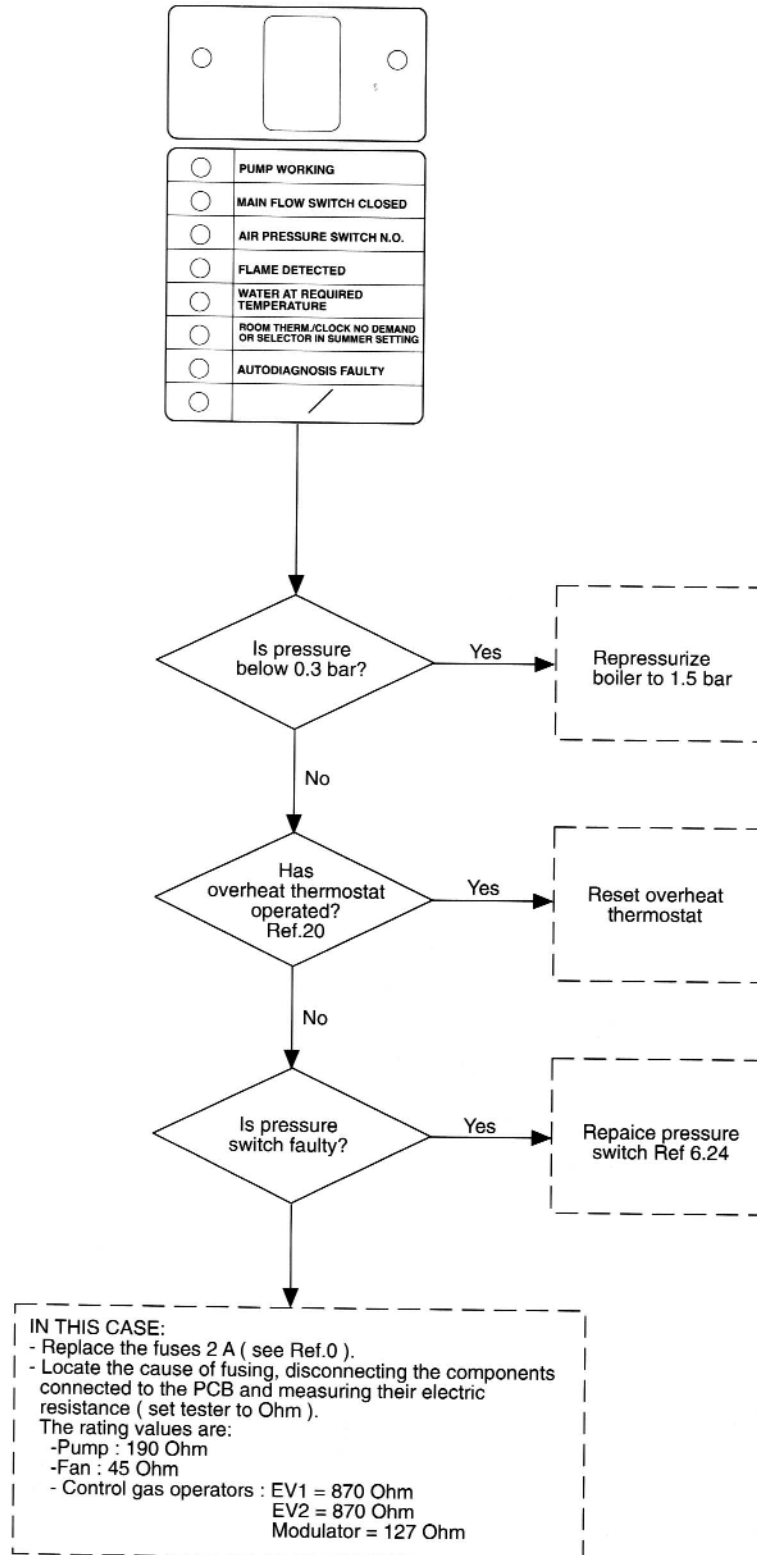

Fault finding

TCS STATE : Ventilation faulty

(letter "A" appears at the end of the autodiagnosis if ventilation is faulty)

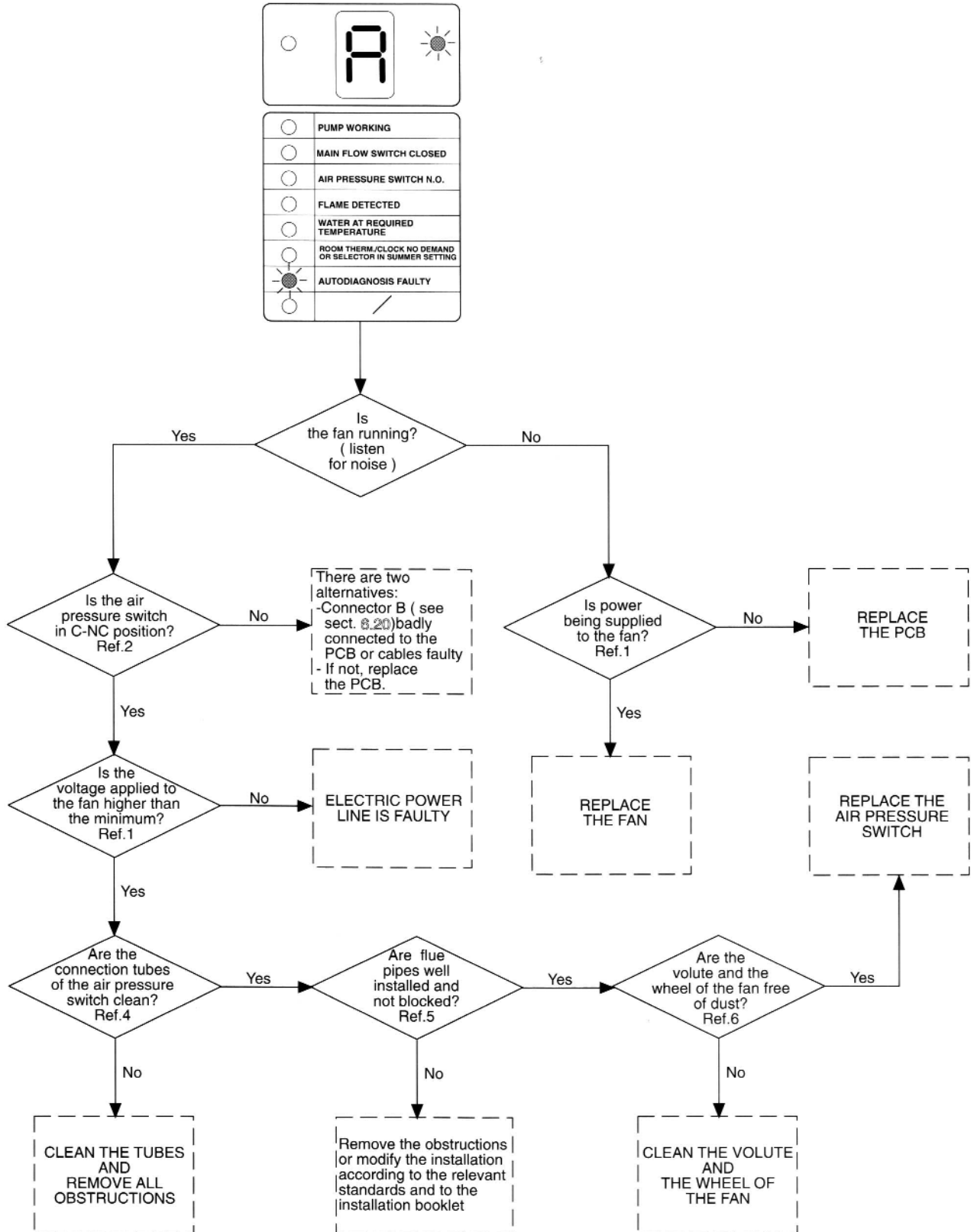

Fault finding

Ref.1

Supply voltage (230 VAC $-10\% \div +15\%$) should be indicated by terminals of the fan.
Set the tester to VAC.

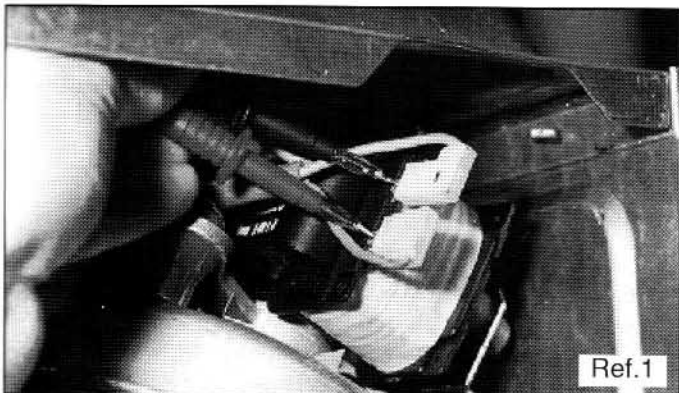

Ref.2

Verify that C and NC connectors of the air pressure switch are closed, measuring the resistance between them that must be zero.
Set the tester to Ohm.

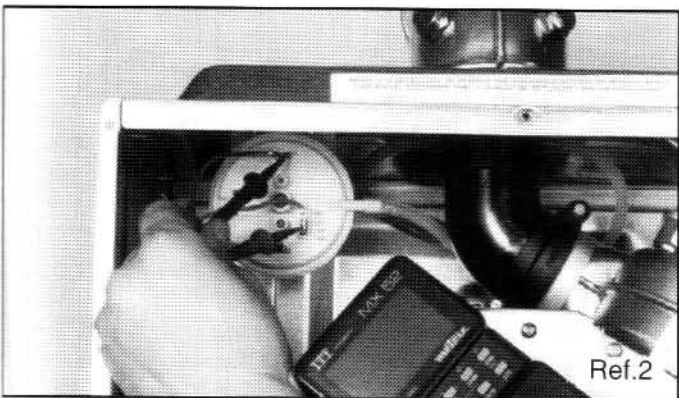

Ref.3

Verify that the connector B is properly fitted to the PCB terminal and that the cables are not damaged.

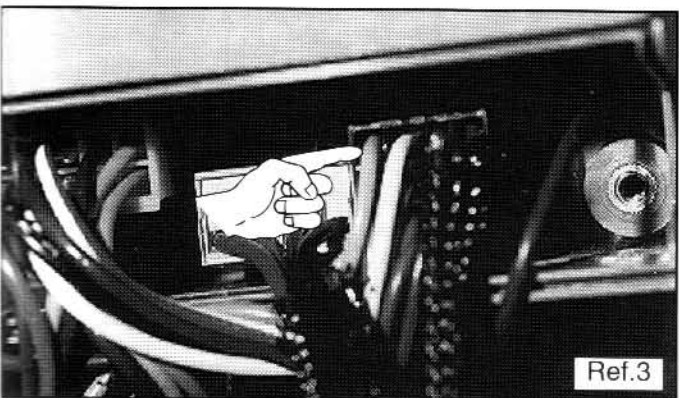

Ref.4

Verify that the No.2 siliconic transparent static pressure tubes are free of dust or condensation and that also the "venturi" is not blocked.

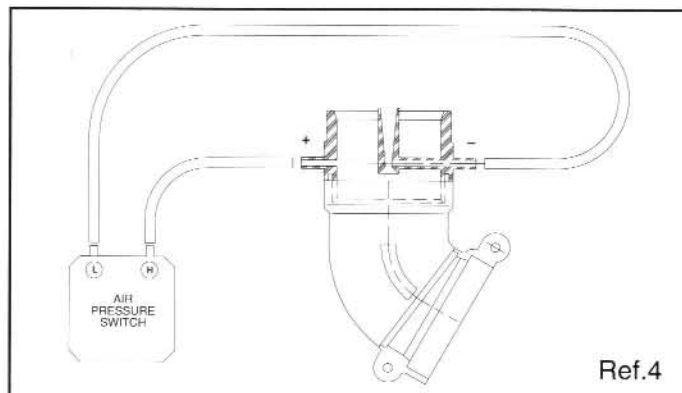

Ref.5

Verify the flue pipes and the terminal as follows:

- They are installed according to the relevant standards;
- The diameter of the flue pipes, the total length and the number of the elbows are according to the installation booklet;
- There are no obstructions inside the flue pipes;
- There are no obstructions in the outside openings of the air inlet and flue gas discharge.

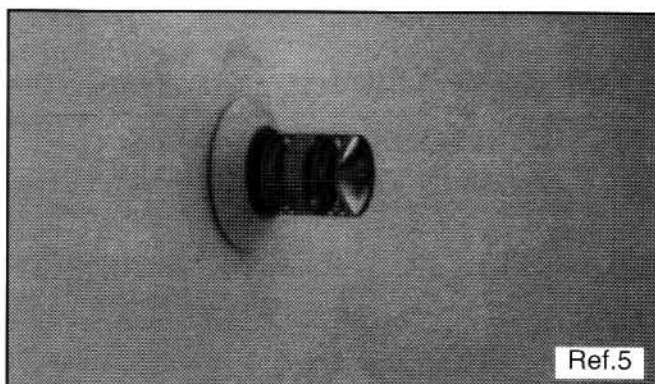

Ref.6

Do as follows:

- Remove the fan according to the sect. 6.19 of the installation booklet;
- See from the open section of the fan if there is enough dust to reduce the rate of flow.

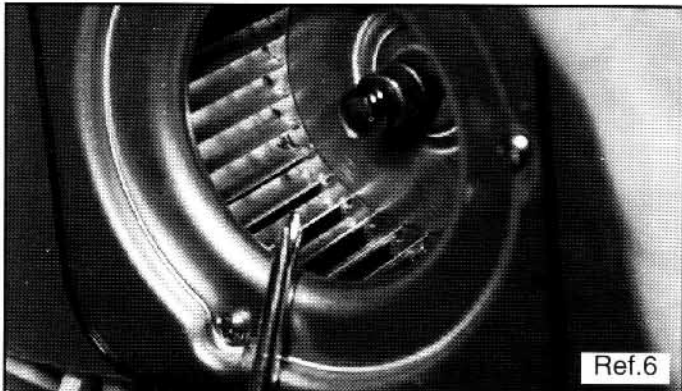

Fault finding

TCS STATE : Air pressure switch stuck in C-NO position

(letter "B" appears during the autodiagnosis if the air pressure switch indicates ventilation before the fan is activated)

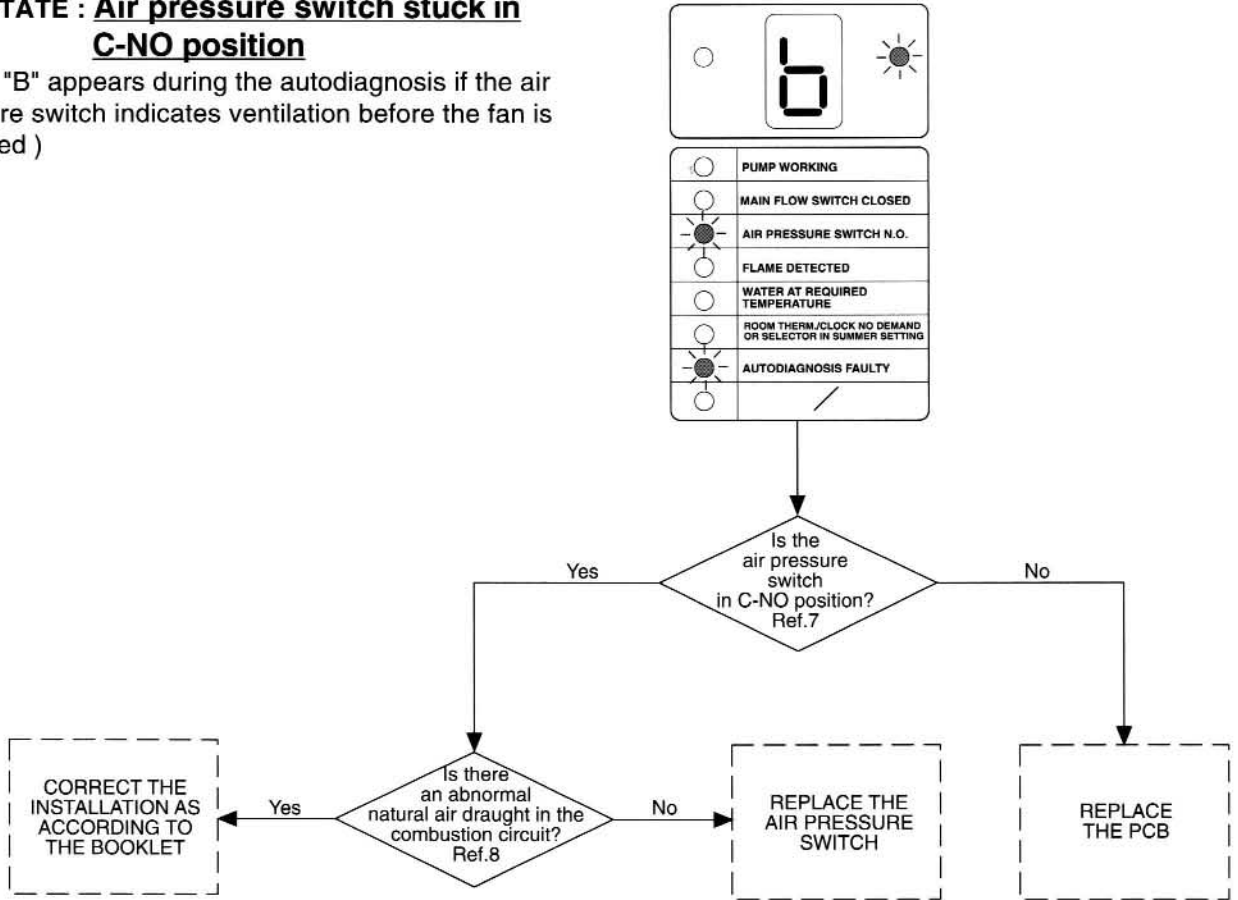

TCS STATE : Resetting switch pressed

(letter "C" appears during the autodiagnosis if the reset switch is pressed or in short circuit)

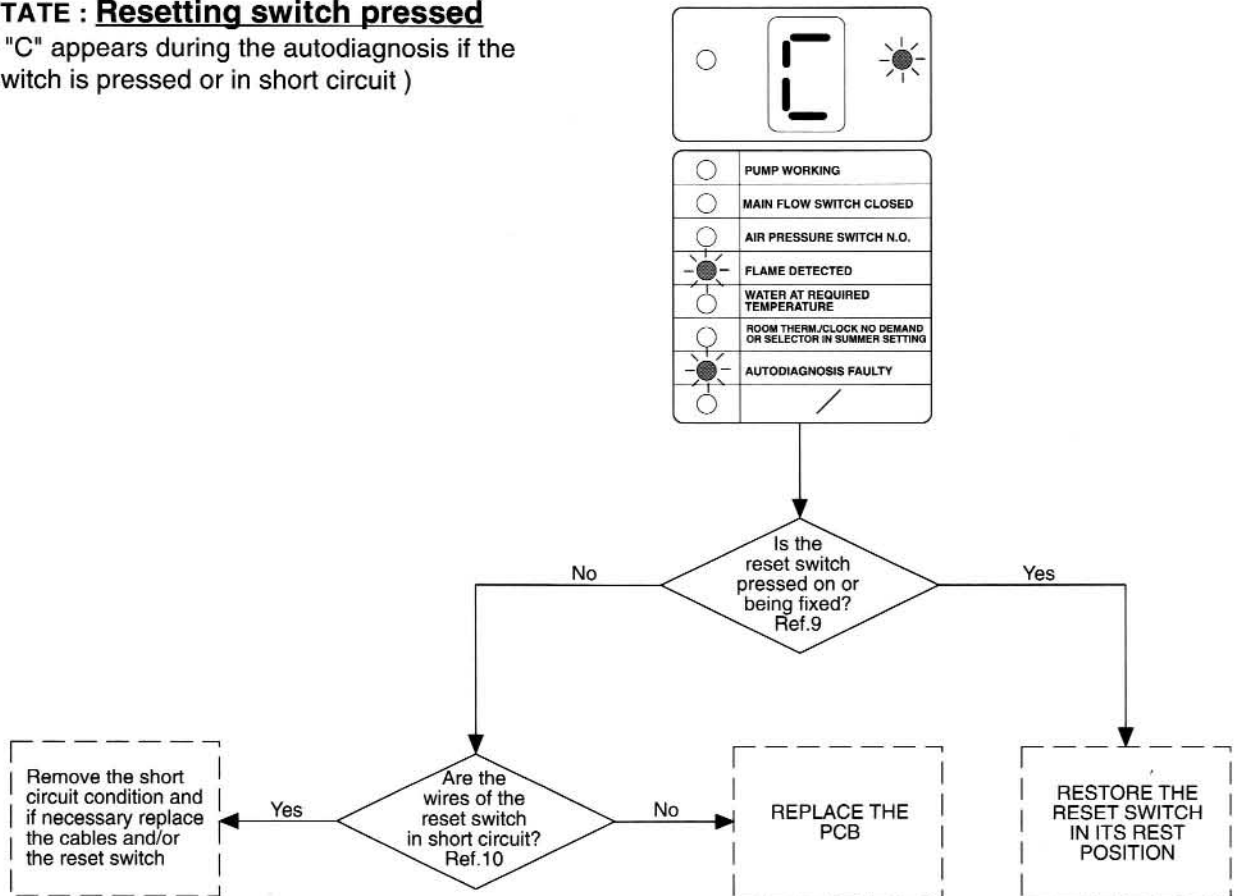

Fault finding

Ref.7

Verify that C and NO connectors of the air pressure switch are closed, measuring the resistance between them that must be zero.

Set the tester to Ohm.

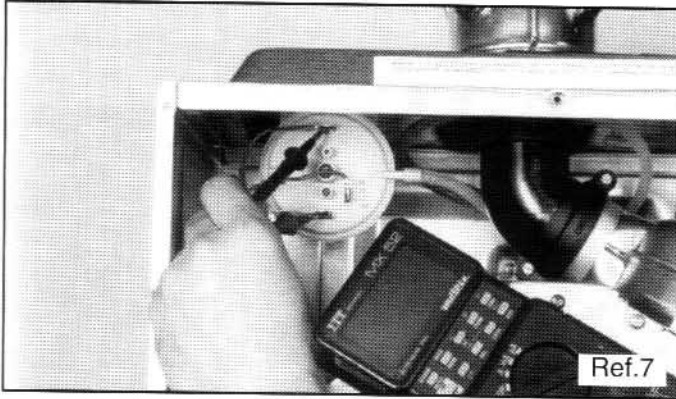

Ref.8

Verify the flue pipes and the terminal as follows:

- they are installed according to the relevant standards;
- they are installed according to the installation booklet mainly as it concerns the need of an orifice when the total length is lower to a given valve.

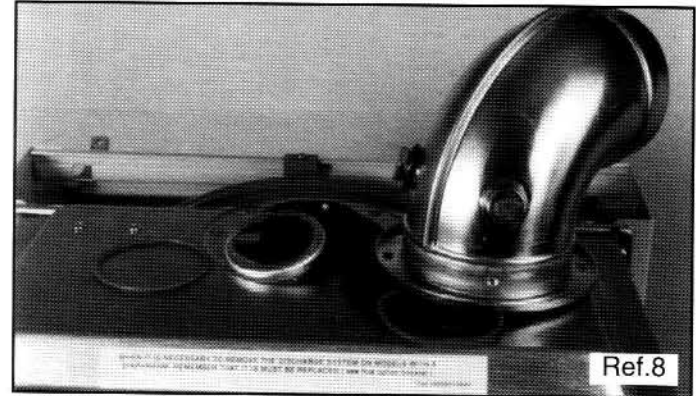

Ref.9

The check can be done visually.

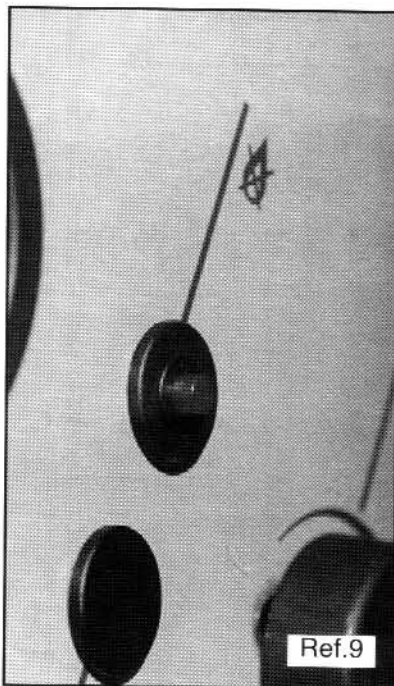

Ref.10

Verify that the resistance between the two pins is infinity. Set the tester to Ohm.

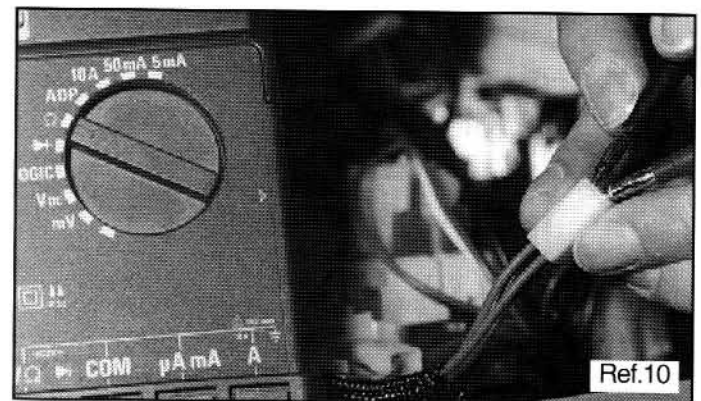

Fault finding

TCS STATE : Faulty flame supervision device

(letter "E" appears during the autodiagnostic if there is a supervised flame before opening the gas valve)

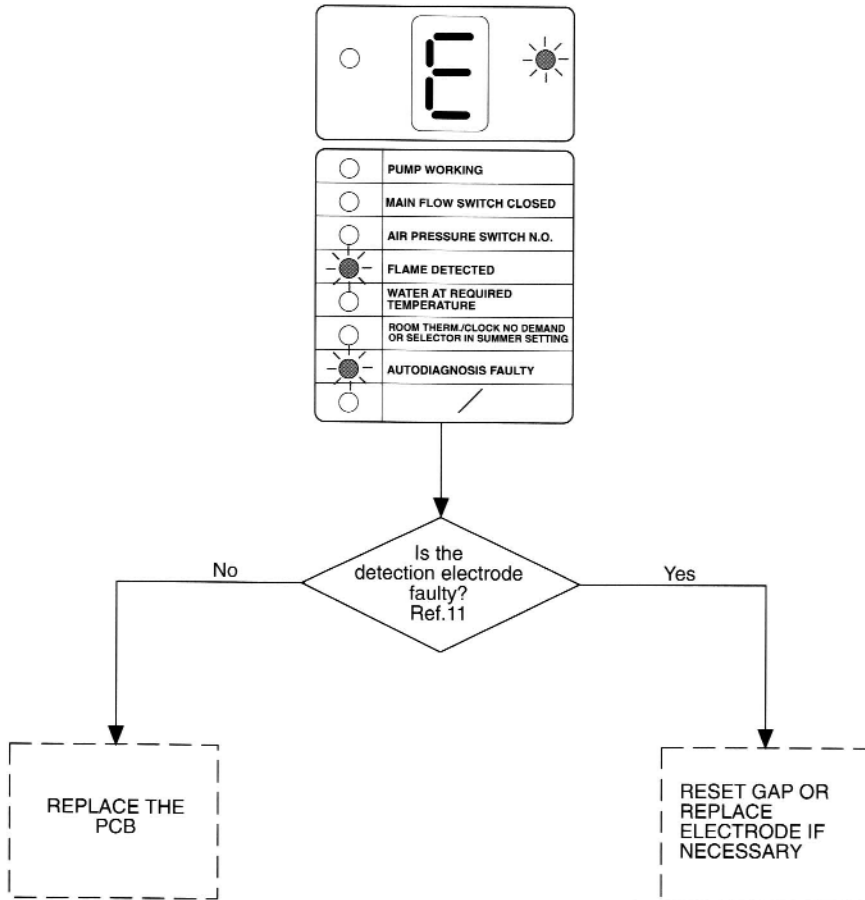

Fault finding

Ref.11

Verify the distance of the terminal of the detection electrode to the burner; it can be from 5 to 7 mm (see Fig. Ref.11-a).

Set the tester to DC (μA).

The tester should be connected in series with the detection circuit (see Fig. Ref.11-b).

The value of detection current without flame must be lower than $0.5 \mu\text{A}$.

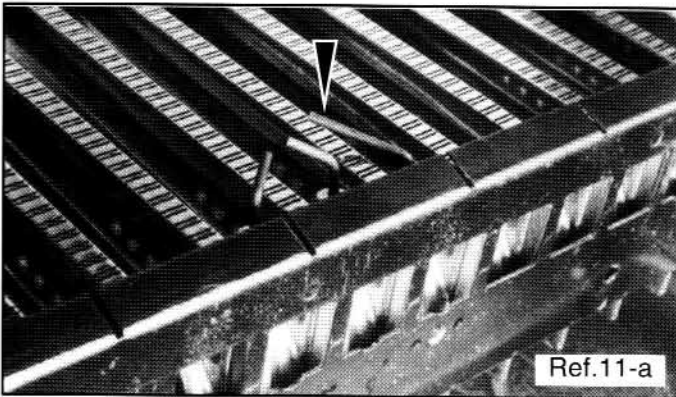

Fault finding

TCS STATE : Lockout (red light on the reset push button)

(number "4" appears if the flame is not detected:
 1 - or at the end of a complete ignition sequence;
 2 - or when, as a consequence of a disappearance of the

flame without the gas supply having been interrupted, the ignition device fault).

Note: Lockout is not a default in itself; it is only a fault if the lockout is repetitive.

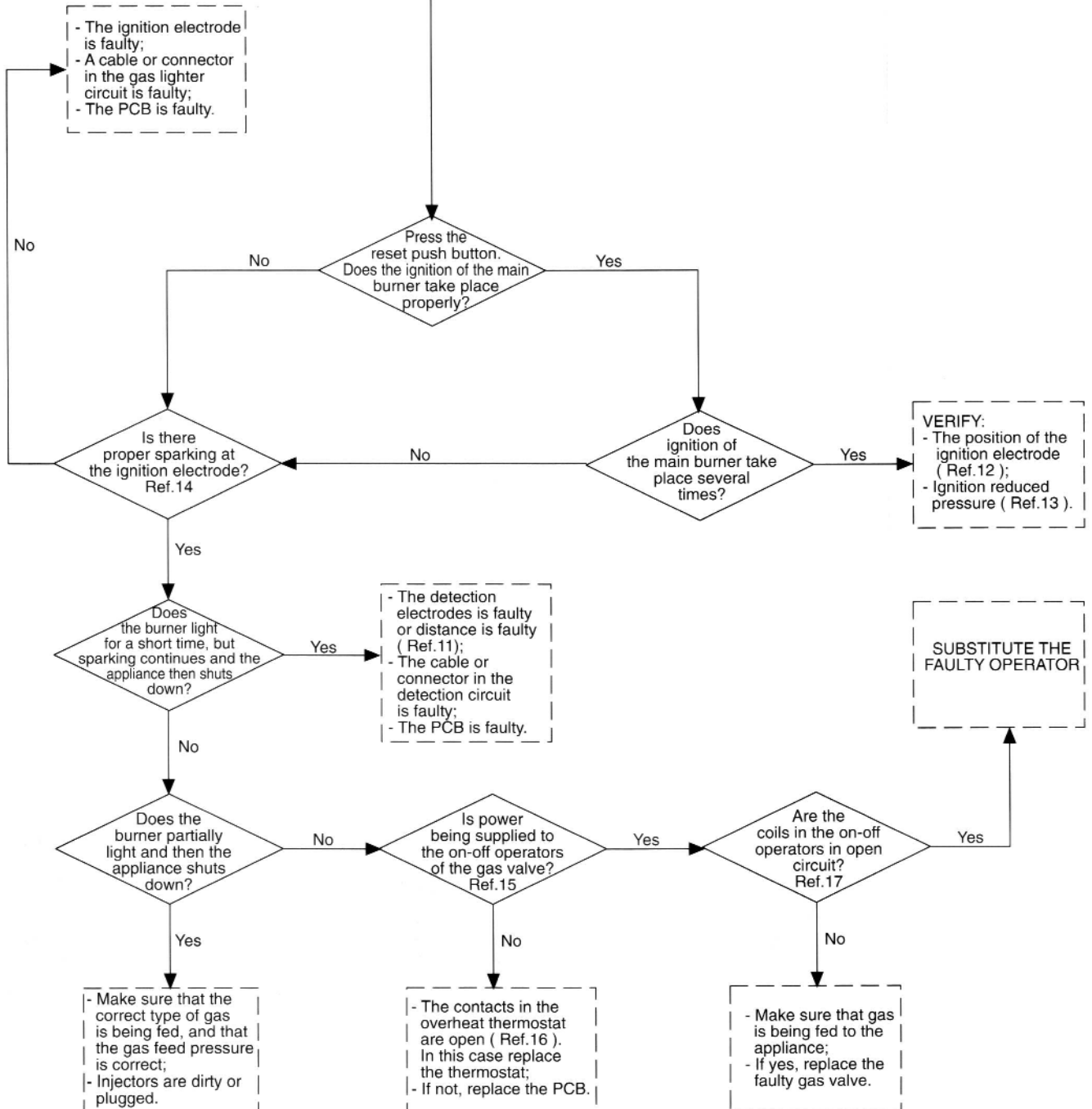
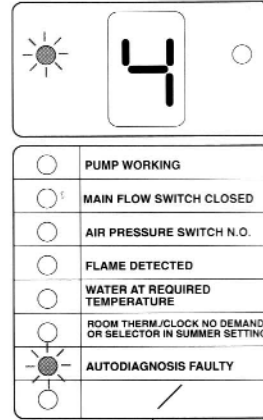

Fault finding

Ref.12

Verify that the distance between the terminal of the ignition electrodes and the burner is about 5 mm.

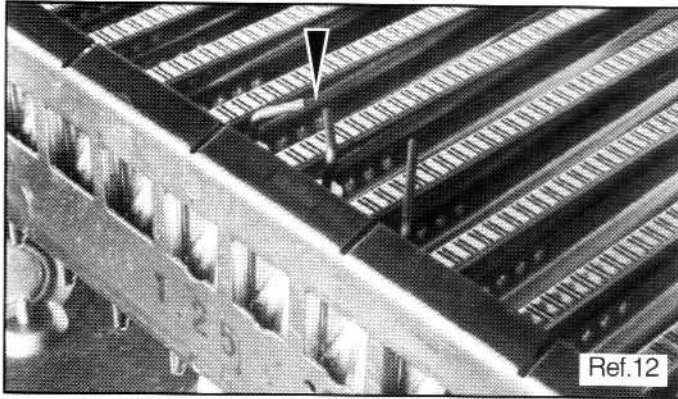

Ref.12

Ref.13

Install a manometer in the outlet pressure intake of the gas valve.
Remove the detection electrode and activate an ignition cycle.
As ignition is attempted measure the gas pressure.
Verify that this value is according to the installation booklet.

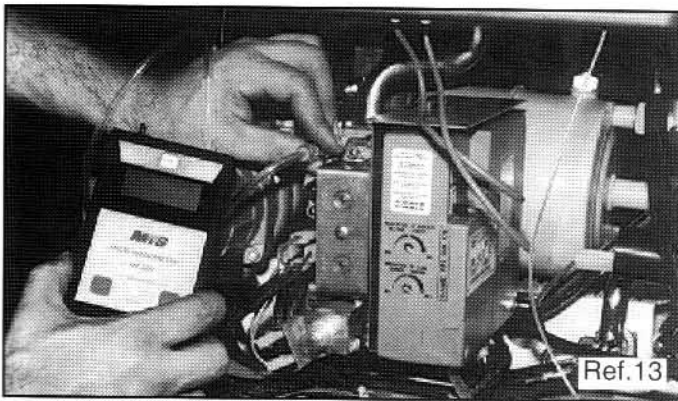

Ref.13

Ref.14

Verify visually that sparks are on the burner and distance is according to ref.12.

Ref.15

Supply voltage should be indicated when power is supplied to the operators.
Take measurements with the device reset from shut-down.
Set the tester to VAC.

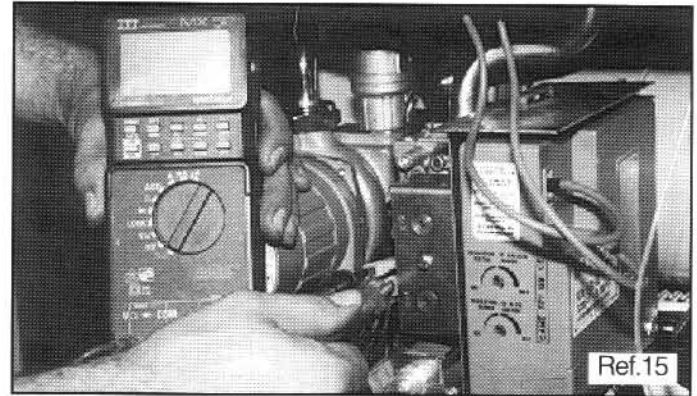

Ref.15

Ref.16

Disconnect the terminals of the overheat thermostat and measure the resistance that must be zero.
If not the thermostat is open.
Set tester to Ohm.

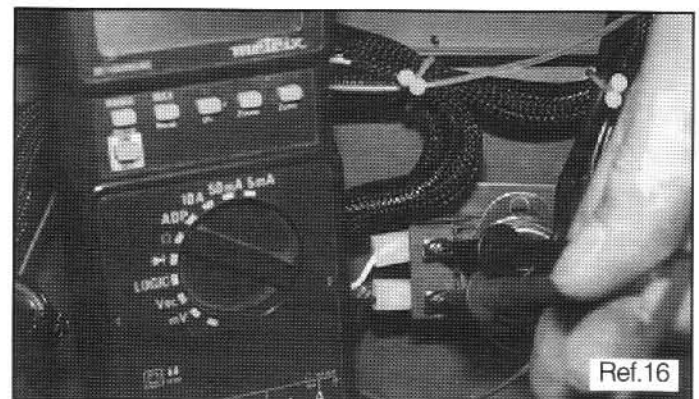

Ref.16

Ref.17

To check the coil in the on-off operators, disconnect the winding from its circuit and measure the resistance; it must be not infinity.

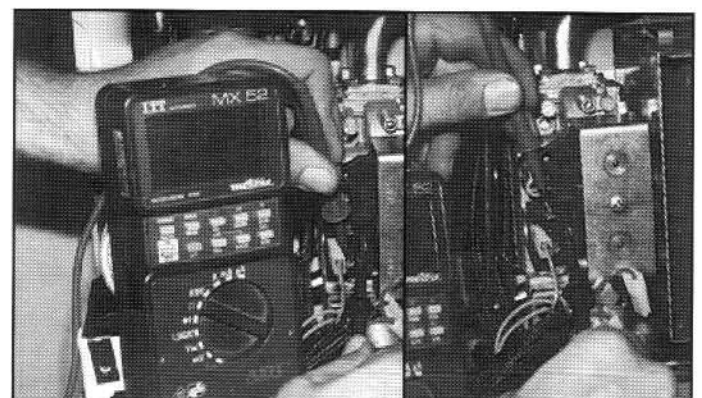

Fault finding

**TCS STATE : There is no demand of heat
due to the internal regulations
of the boiler**

Note: This state is a fault only if it remains indefinitely, even when central heating is called.

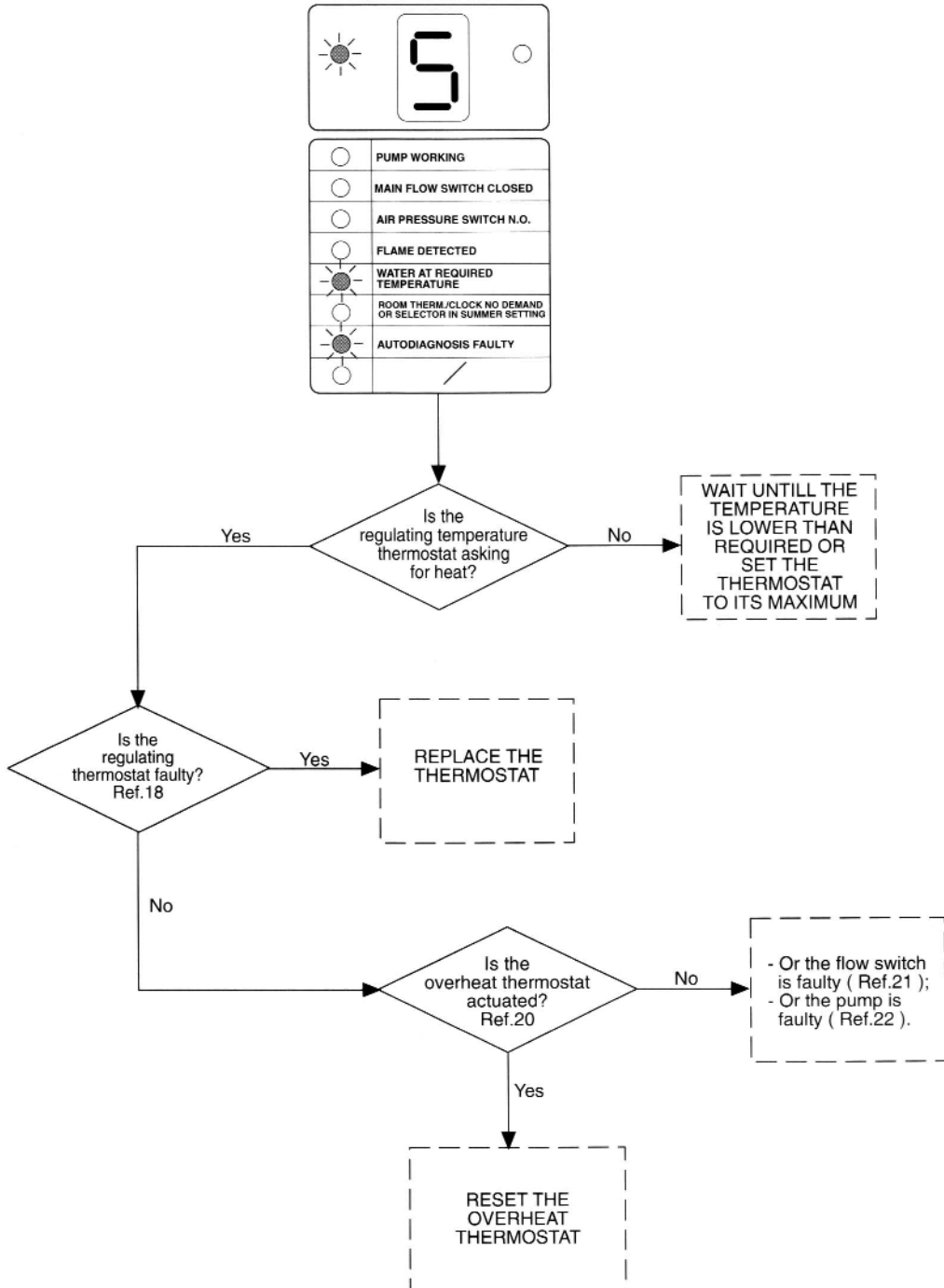

Fault finding

Ref.18

Disconnect the terminals of the thermostat and make measurements of the resistance; it must be zero when the temperature of the bulb is lower than the preset valve. Set tester to Ohm.

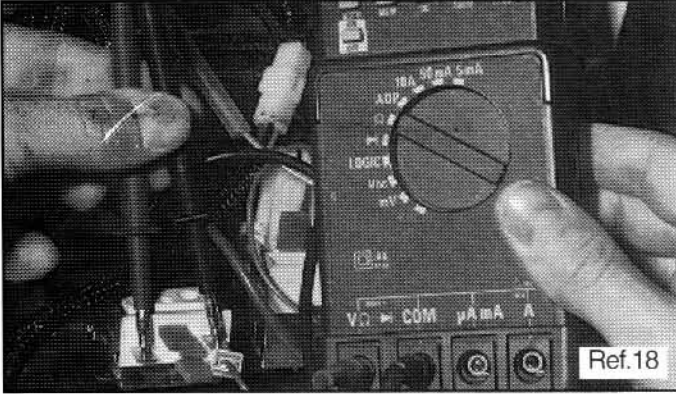

Ref.19

Disconnect the terminals of the thermostat and make measurements of the resistance that must be zero. Set tester to Ohm.

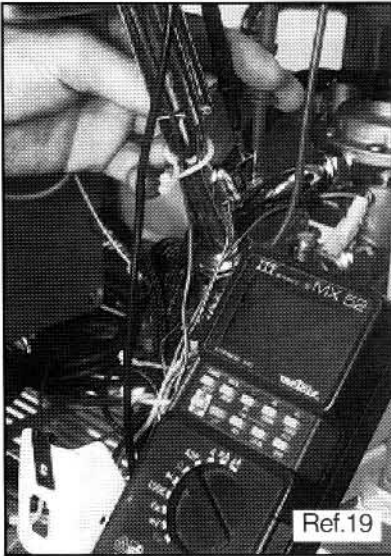

Ref.20

Try to reset the overheat thermostat.

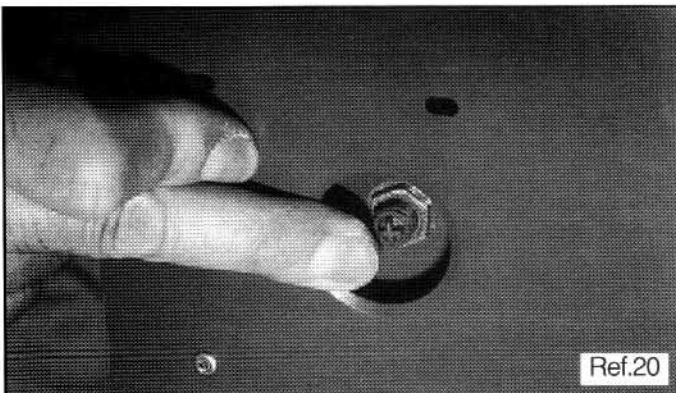

Ref.21

Disconnect the terminals of the flow switch and take measurements of the resistance that must be zero. Set tester to Ohm.

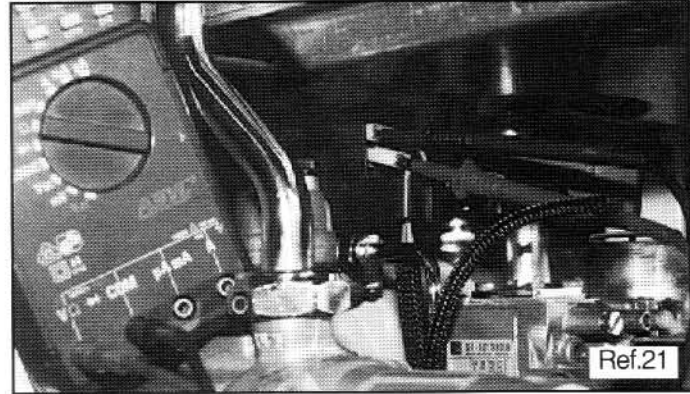

Ref.22

Measure first that supply voltage is supplied to the pump. Set the tester to VAC. Then measure the resistance of the windings of the pump it must be not lower than 190Ω . Set tester to Ohm.

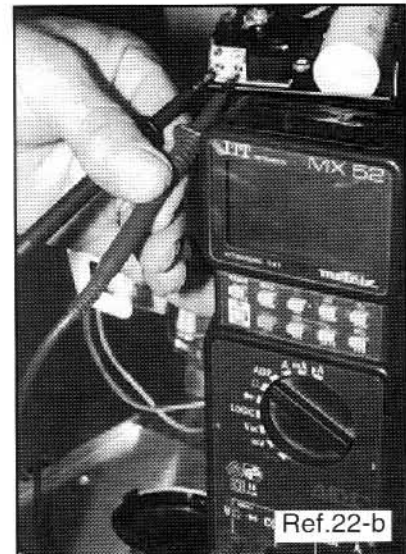
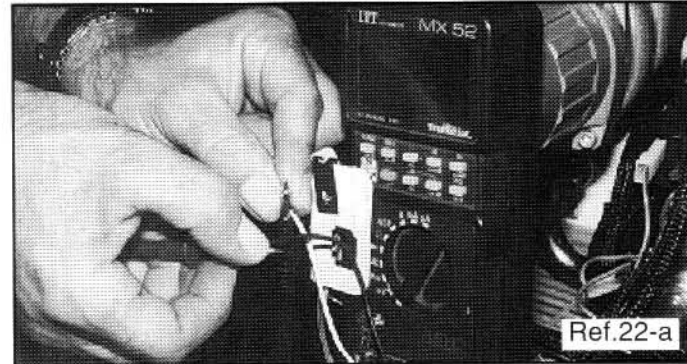

Fault finding

TCS STATE : There is no demand of heat due to the external regulations of the boiler or boiler is switched on "summer" position.

Note: This state is faulty only if it remains indefinitely, even when central heating or hot water are expected.

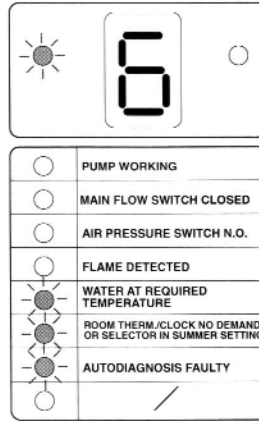

VERIFICATIONS:

- The boiler is switched on "summer" position; heating mode is not allowed.
- In case of hot water demand the flow is under the minimum allowed.
- In case of hot water demand the flow is over the minimum but the divertor valve is faulty. Verify if the microswitch on the valve has been operated by the flow water (Ref.23).
- In case that clock and/or room thermostat are not connected, verify that the relative terminals are bridged according to the wiring diagram.
- In case that clock and/or room thermostat are connected, verify that these devices are electrically closed (asking for heat) : Ref.24.

Fault finding

Ref.23

Measure the voltage between the pink and the red cable on the terminal of the switch.

The value must be zero.

Set tester to VAC.

Ref.24

Measure the resistance between the terminals of the clock and /or the room thermostat.

The value must be zero.

Set the tester to Ohm.

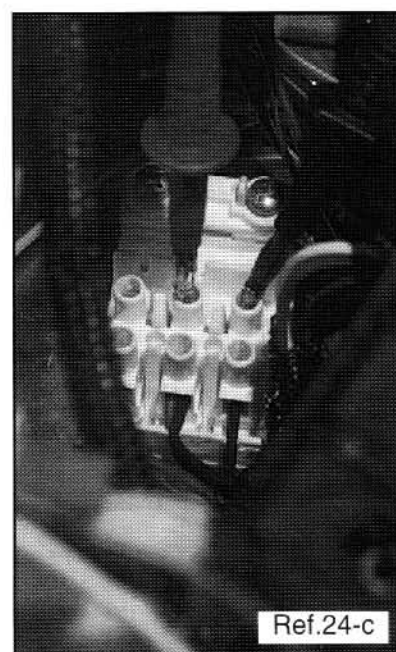
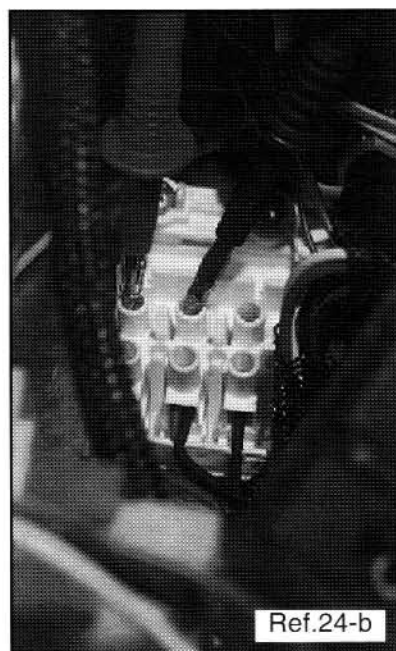

Fault finding

7.5 FAULT FINDING WITHOUT THE UTILIZATION OF THE TOTAL CHECK SYSTEM

The utilization of TCS is the more efficient way to single out a defect, because its message let only a restricted area to be checked.

But in the case of TCS not availability, it is possible to detect and remove the eventual defect utilizing the standard fault finding diagrams described in this chapter.

The checking modes referred to are the same as with utilization of TCS.

7.5.1 APPLIANCE COMPLETELY SHUT DOWN

INITIAL CONDITIONS:

- The main switch is on position "ON" (neon light);

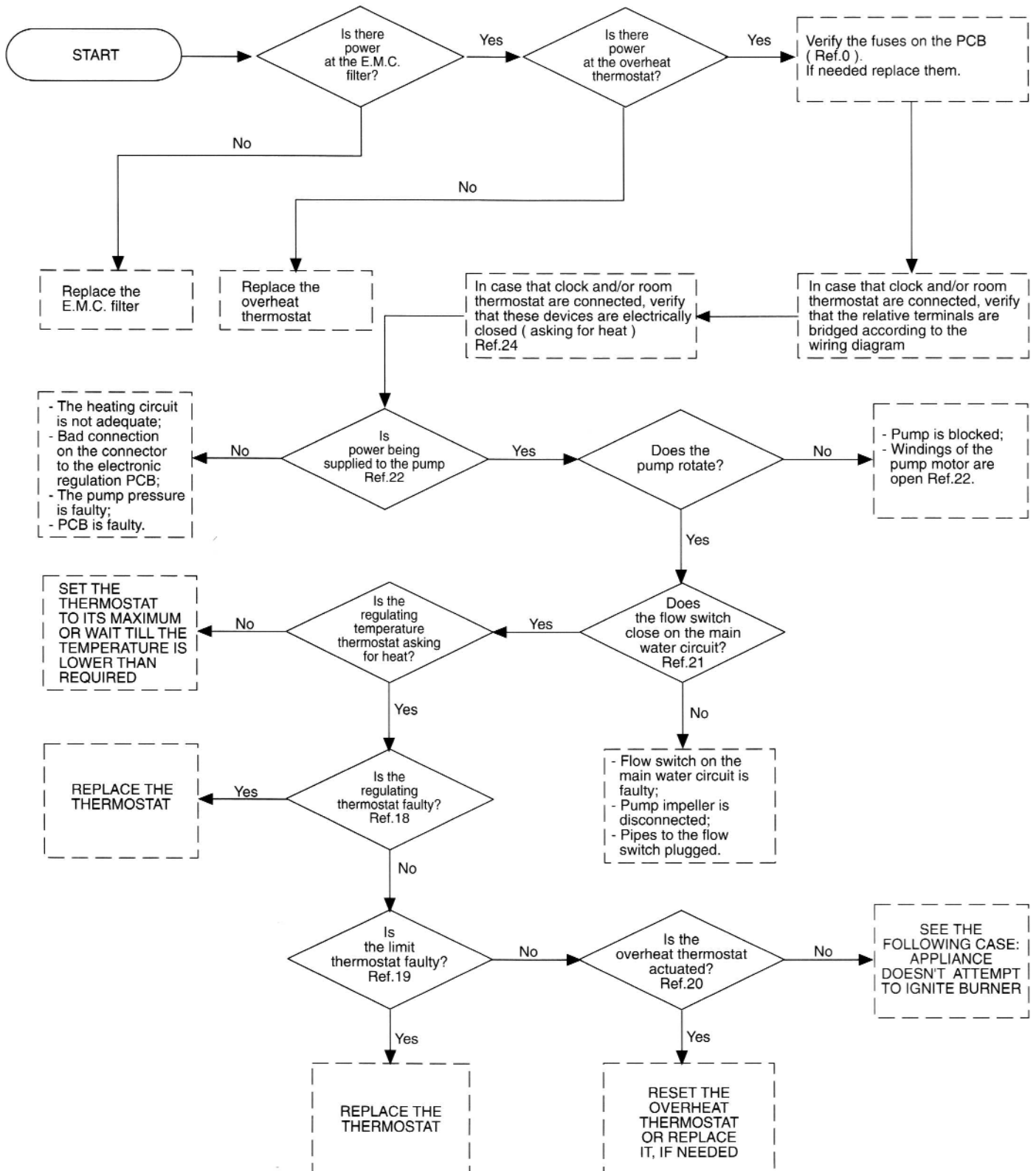

Fault finding

7.5.2 APPLIANCE DOESN'T ATTEMPT TO IGNITE THE BURNER (NO SPARKS)

INITIAL CONDITIONS:

- The main switch is on position "ON" (neon light);
- The boiler is switched on "WINTER" position;
- All preliminary verifications according to 7.5.1 have been done without succes.

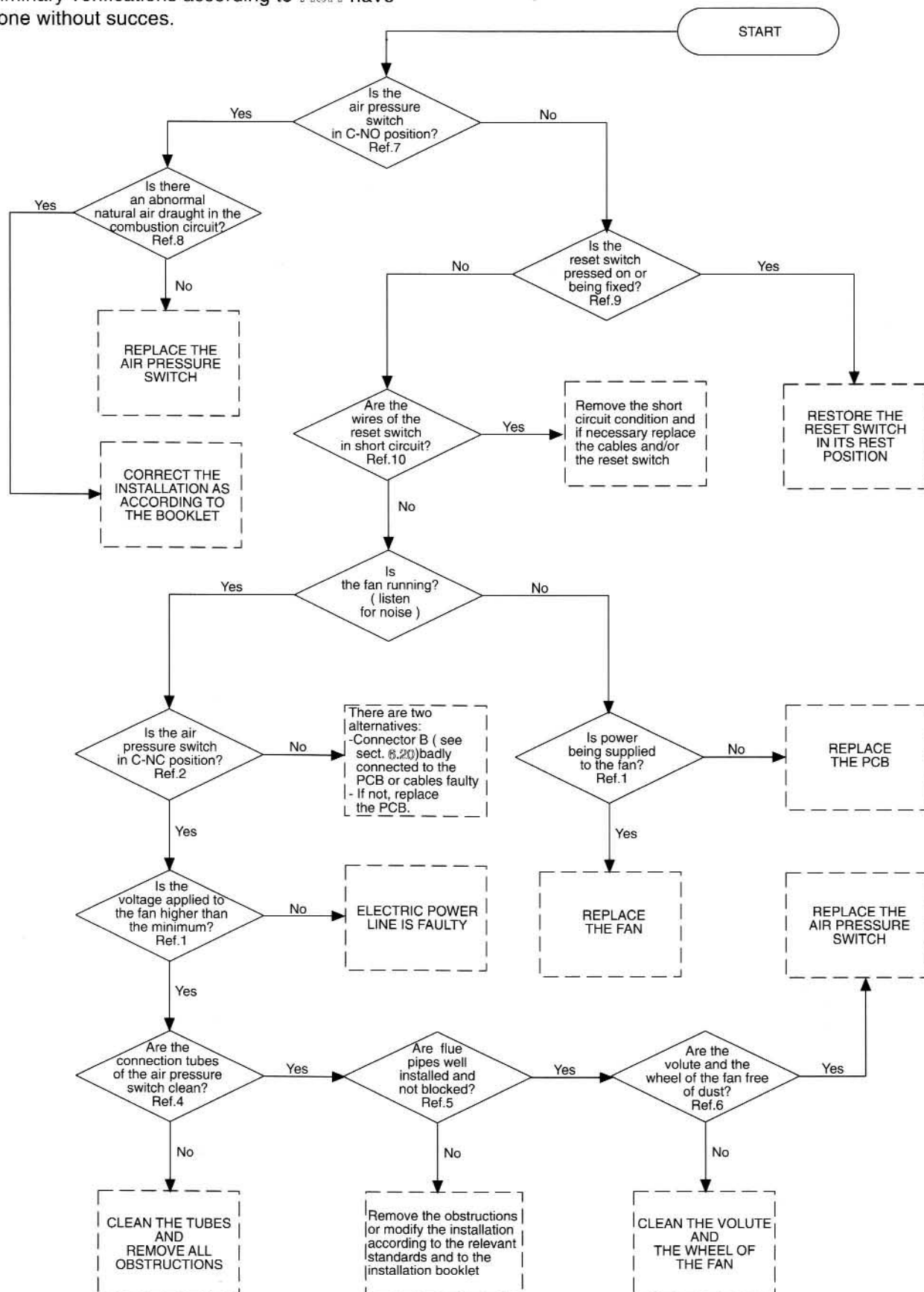

Fault finding

7.5.3 APPLIANCE FAIL FREQUENTLY IGNITION WITH CONSEQUENT LOCKOUT (RED LIGHT ON THE RESET PUSH BUTTON)

INITIAL CONDITIONS:

- The main switch is on position "ON" (neon light);
- The boiler is switched on "WINTER" or "SUMMER" position;
- The thermostat is calling for heat or hot water is expected.

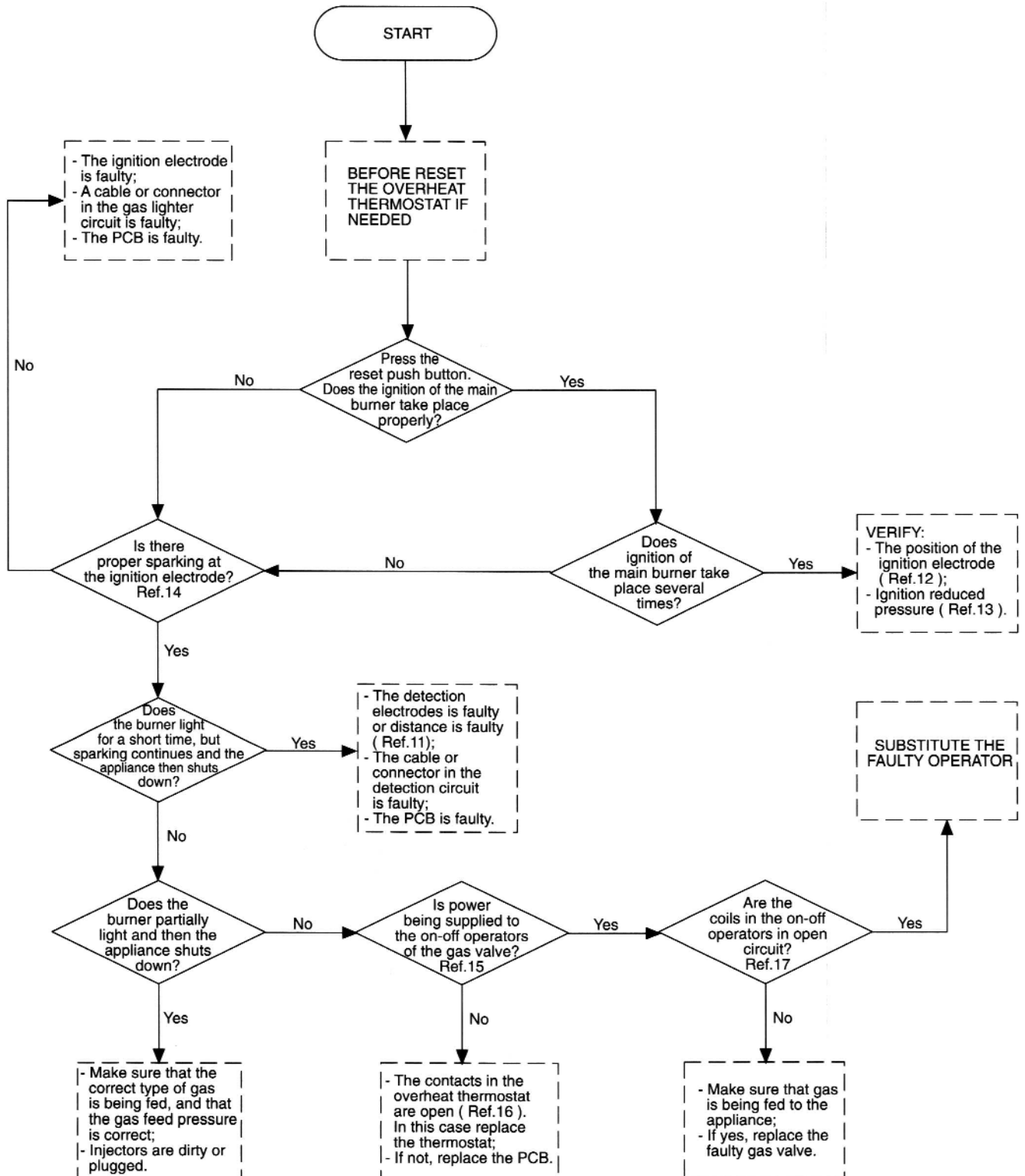

Fault finding

7.5.4 FAULT ON "HOT WATER - SPACE HEATING" SWITCHING

INITIAL CONDITIONS:

- The main switch is on position "ON" (neon light);
- The boiler is switched on "WINTER" position;

CASE A : The appliance operates in the central heating mode only and not in hot water mode.

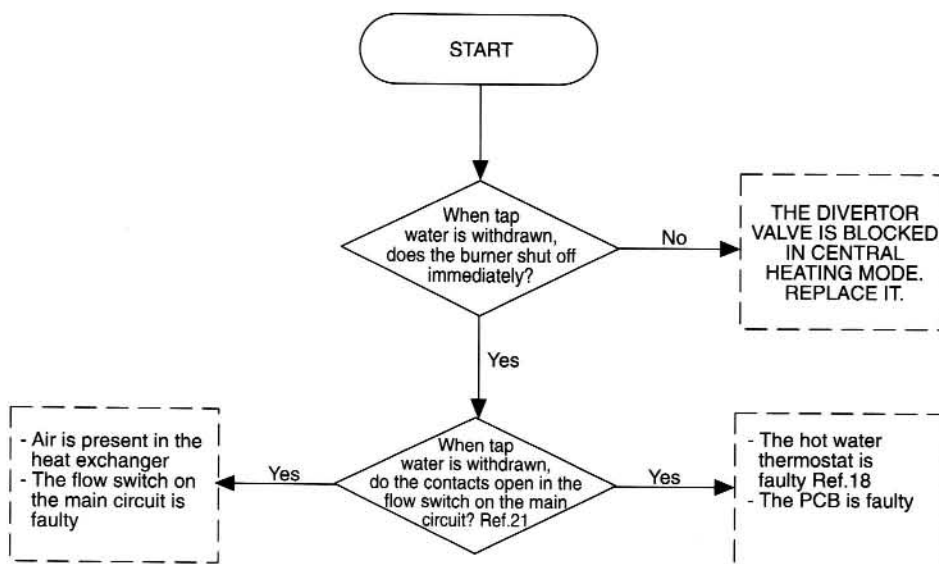

CASE B : The appliance operates in the hot water mode only and not in central heating mode.

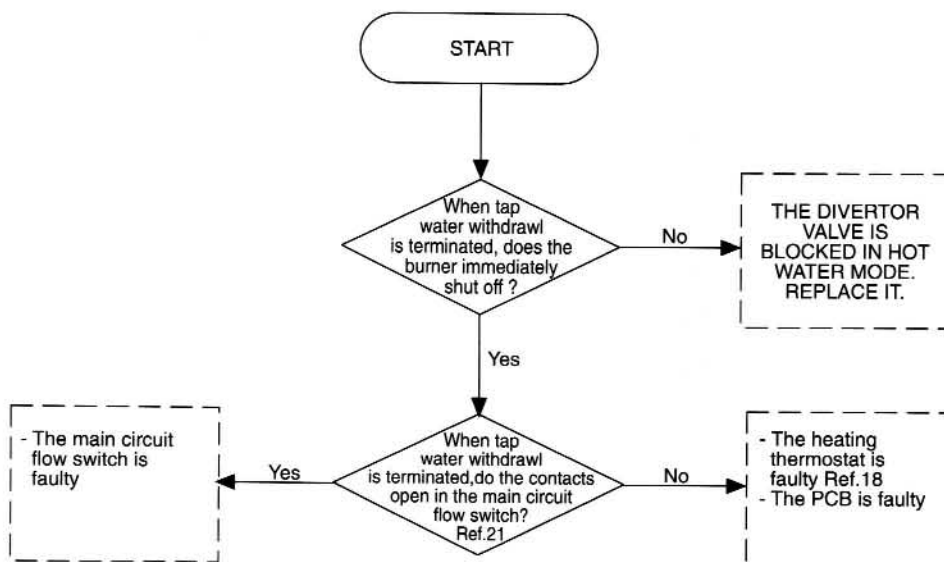

8 ELECTRIC DIAGRAMS

8.1 ELECTRICAL CONNECTION

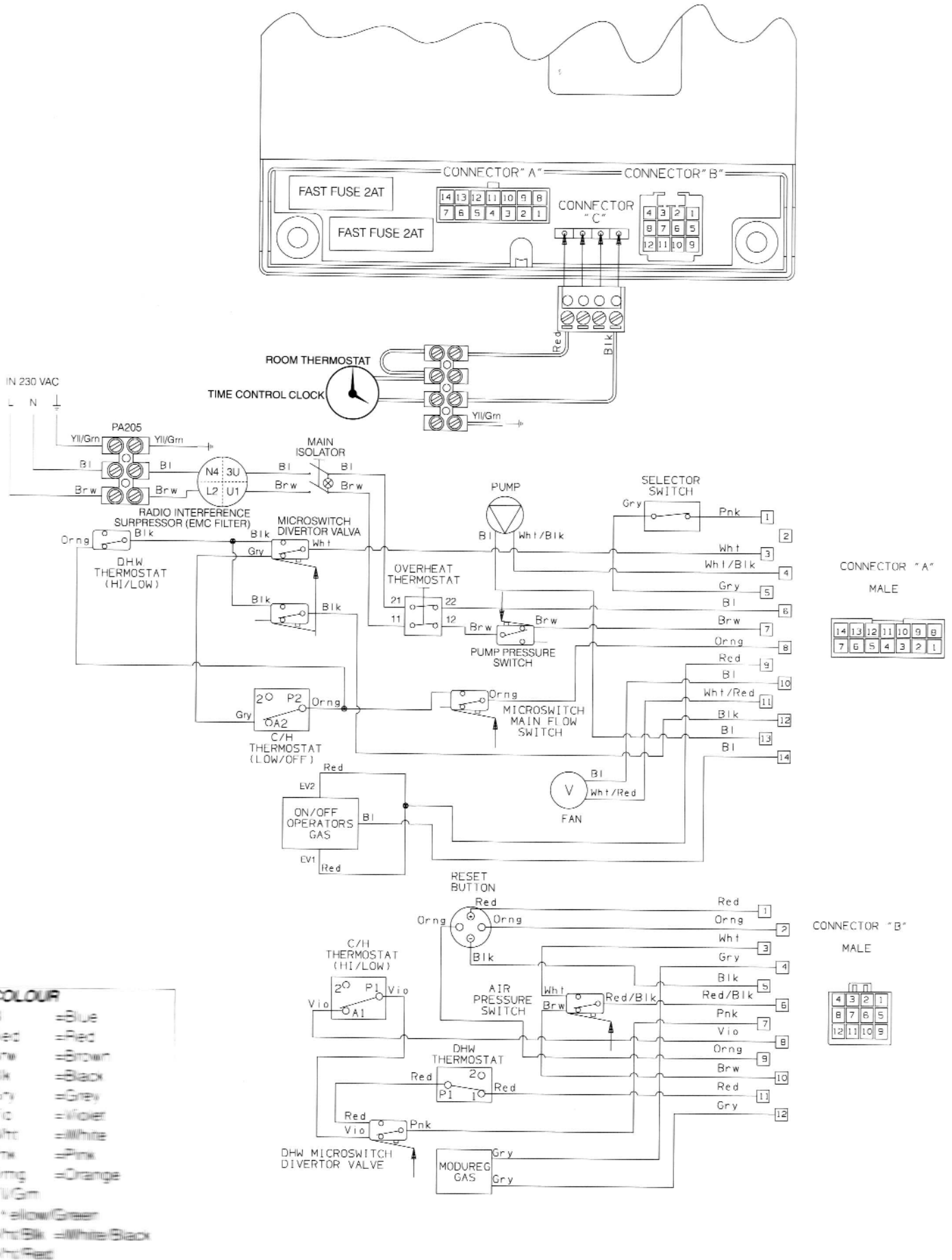

Electric diagrams

3.2 FUNCTIONAL FLOW CONNECTION

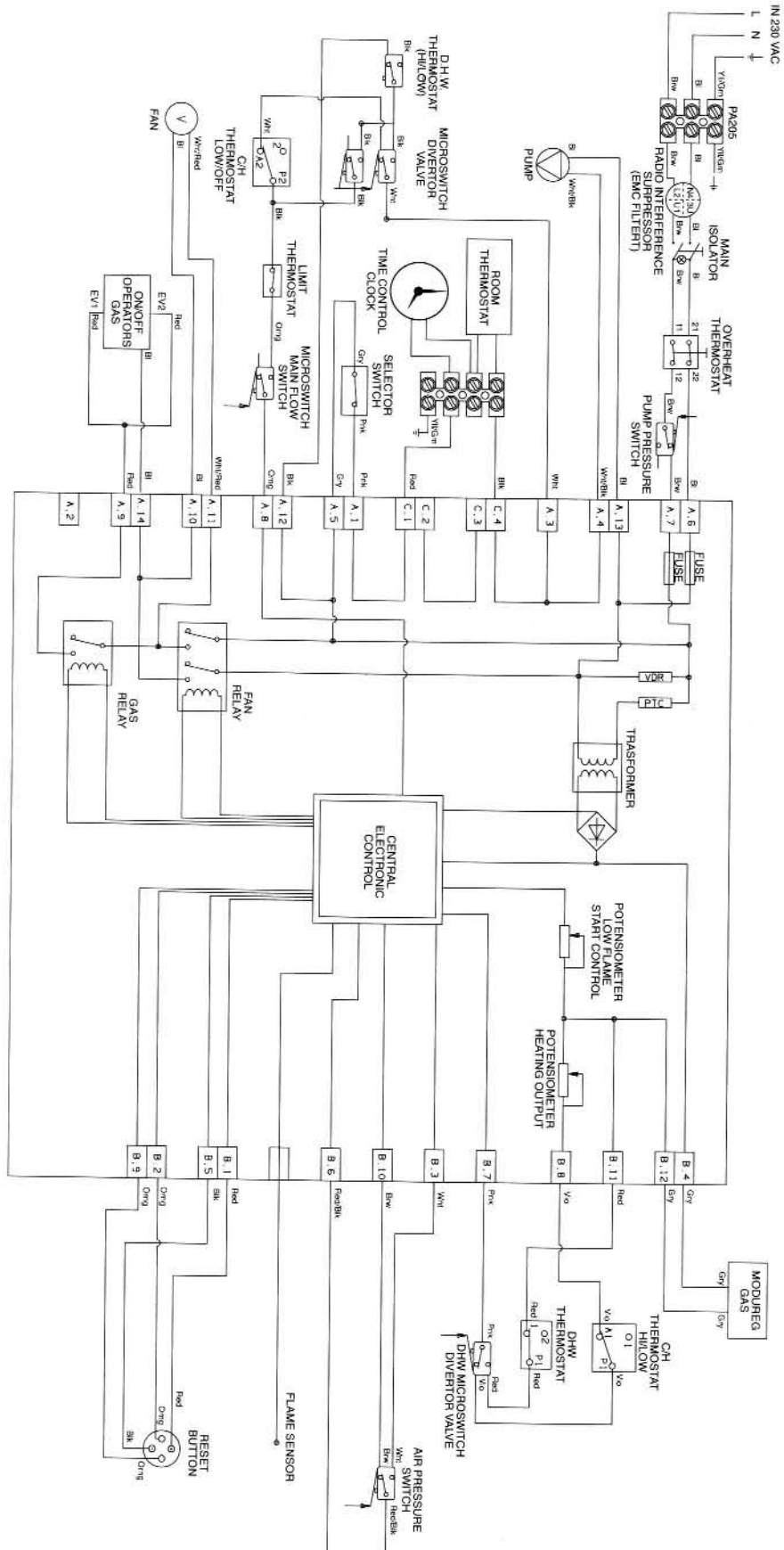

COLOUR

- Bl =Blue
- Red =Red
- Brw =Brown
- Blk =Black
- Gry =Grey
- Vio =Violet
- Wht =White
- Pnk =Pink
- Org =Orange
- Yll/Grn =Yellow/Green
- Wht/Blk =White/Black
- Wht/Red

Short spare parts list

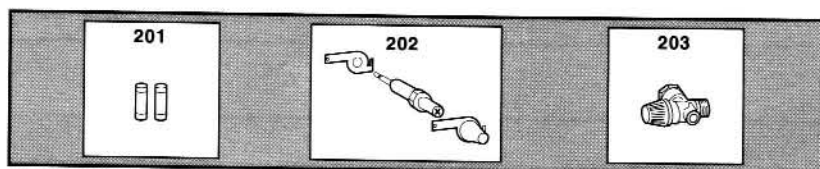
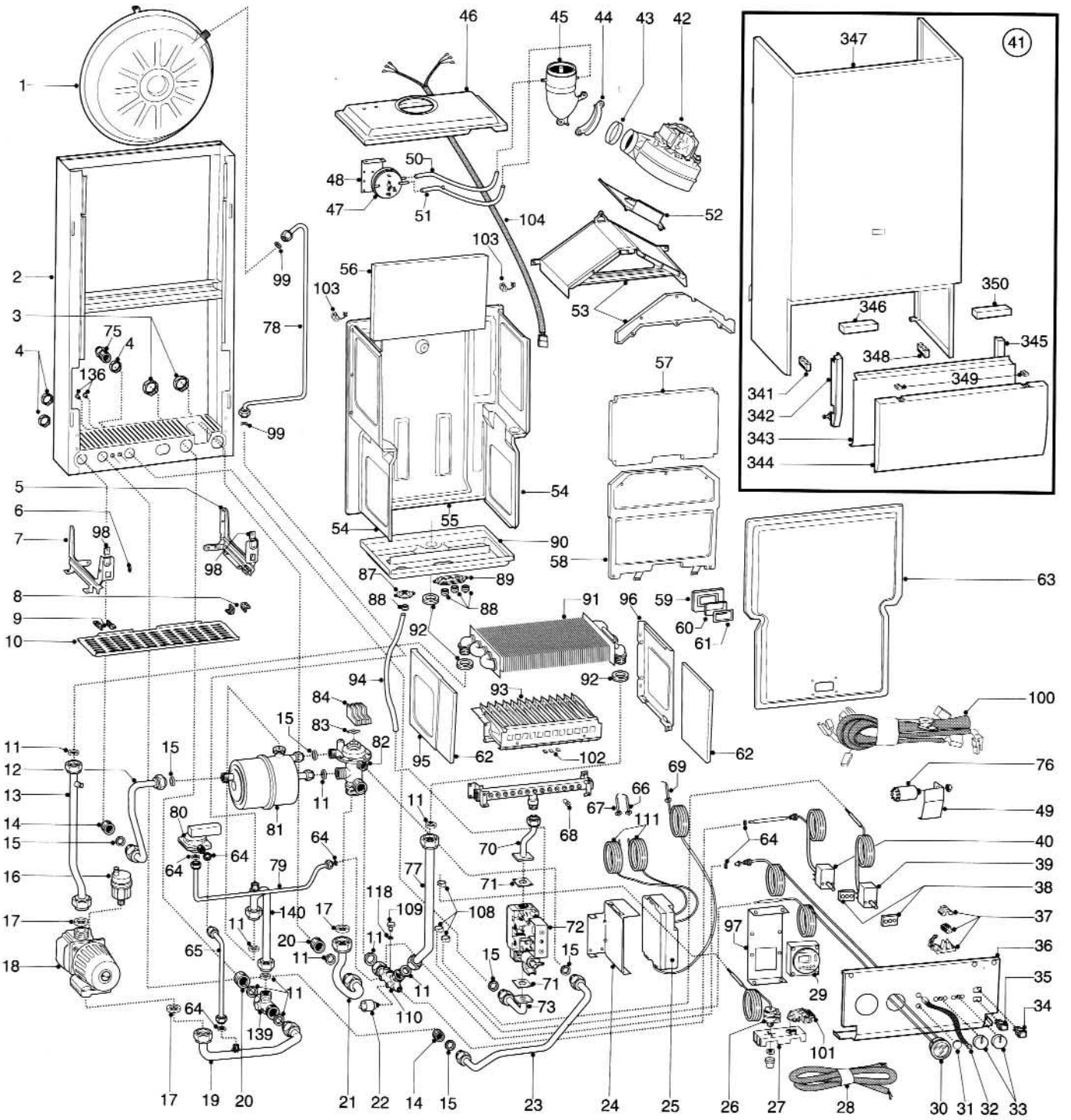

CONTROL PANEL

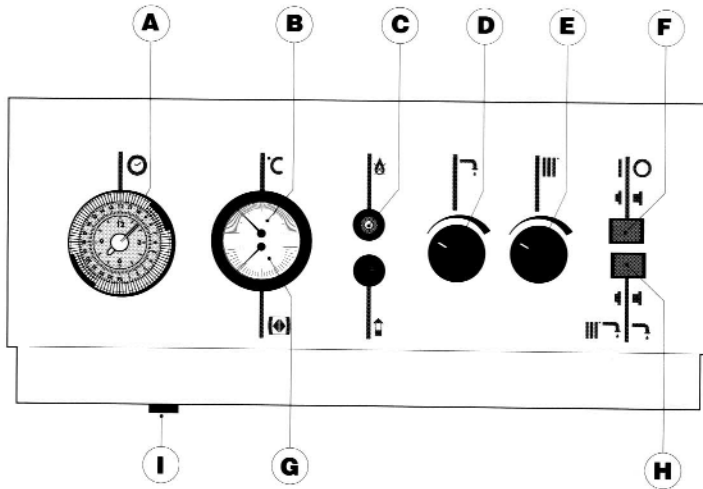

- A: Central heating time control clock
- B: Central heating flow temperature gauge
- C: Red warning light
- D: Domestic hot water temperature control
- E: Central heating temperature control
- F: On/off switch with neon light
- G: Water pressure gauge
- H: Summer/winter switch
- I : Safety thermostat reset

RESIDUAL HEAD OF THE CIRCULATOR

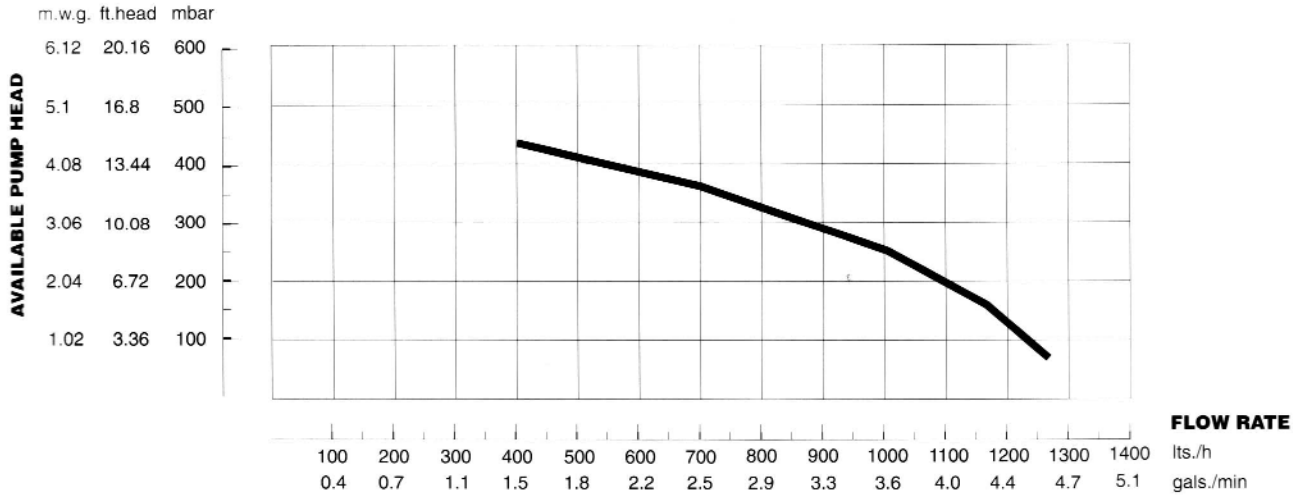

REGULATING HEATING POWER FOR NATURAL GAS (G20)

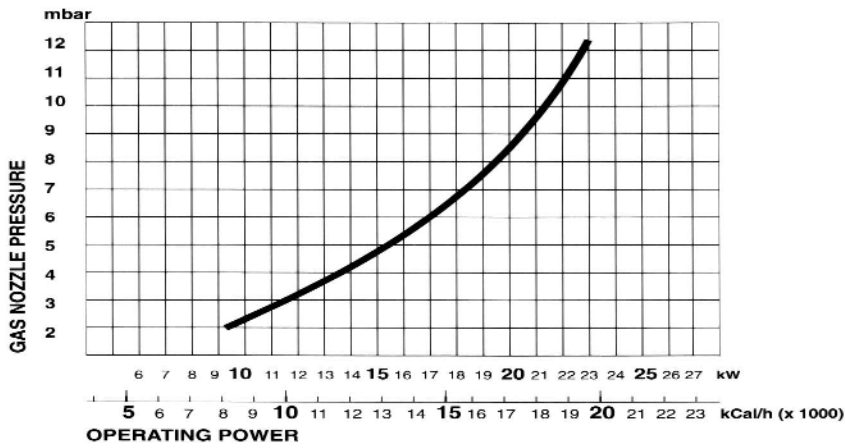

REGULATING HEATING POWER FOR BUTANE GAS (G30)

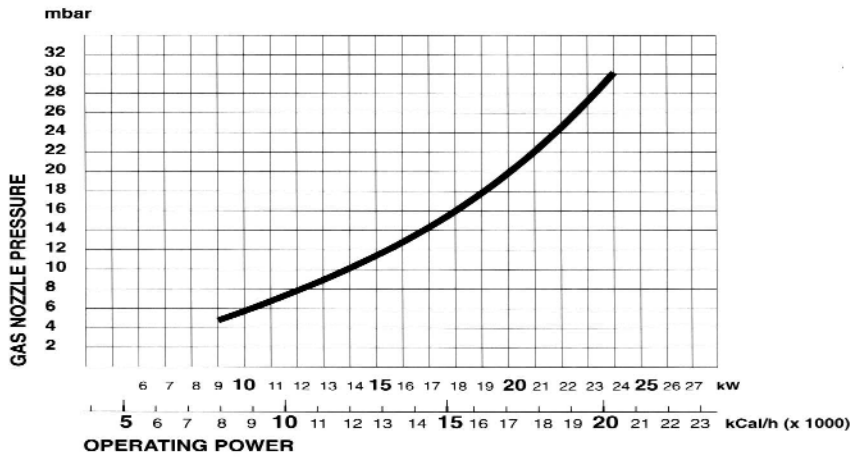

REGULATING HEATING POWER FOR PROPANE GAS (G31)

