

Electric Heating

Ensure the upper rocker switch is to the left (red), the middle rocker switch to the right (electric heating) and the lower rocker switch to the left (normal) and your Space Saver will switch on. Moving the lower rocker switch to boost will not increase the heat output. Moving the upper rocker switch to its centre position will turn off the Space Saver.

For your safety this Space Saver heater is fitted with automatic overheat protection. If the heater stops, turn off the power at the fused spur, wait 5 minutes and switch the power back on.

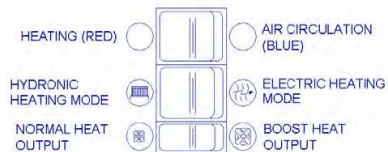

Approved CQS ISO9000: 2008



RECYCLE

Products with this symbol (crossed out wheelie bin) cannot be disposed as household waste. Old electrical and electronic equipment must be recycled at a facility capable of handling these products and their waste by-products. If you are purchasing replacement equipment your retailer may offer a 'take back' scheme, or will be able to give details of the nearest approved authorised treatment facility. Proper recycling and waste disposal will help conserve resources whilst preventing detrimental effects on our health and the environment.

WEEE Registered Code:

WEE/ED0093VW

This appliance is not intended for use by persons (including children) with reduced physical, sensory or mental capabilities, or lack of experience and knowledge, unless they have been given supervision or instruction concerning use of the appliance by a person responsible for their safety. Children should be supervised to ensure that they do not play with the appliance.



Smith's Environmental Products Ltd,

Blackall Industrial Estate, South Woodham Ferrers, Chelmsford, Essex, CM3 5UW

Tel: 01245 324900 Fax: 01245 324422

Sales E-mail: sales@smiths-env.com General Information E-mail: info@smiths-env.com Web: www: smiths-env.com

For Ireland, contact MT Agencies (Ireland) Ltd on Tel: 00353 1 844 3212

As part of the policy of continuous product improvement, Smith's Environmental Products Ltd reserves the right to alter specification without prior notice.

SS5 /Dual Space Saver

Installation and User Guide

Discover the hidden benefits

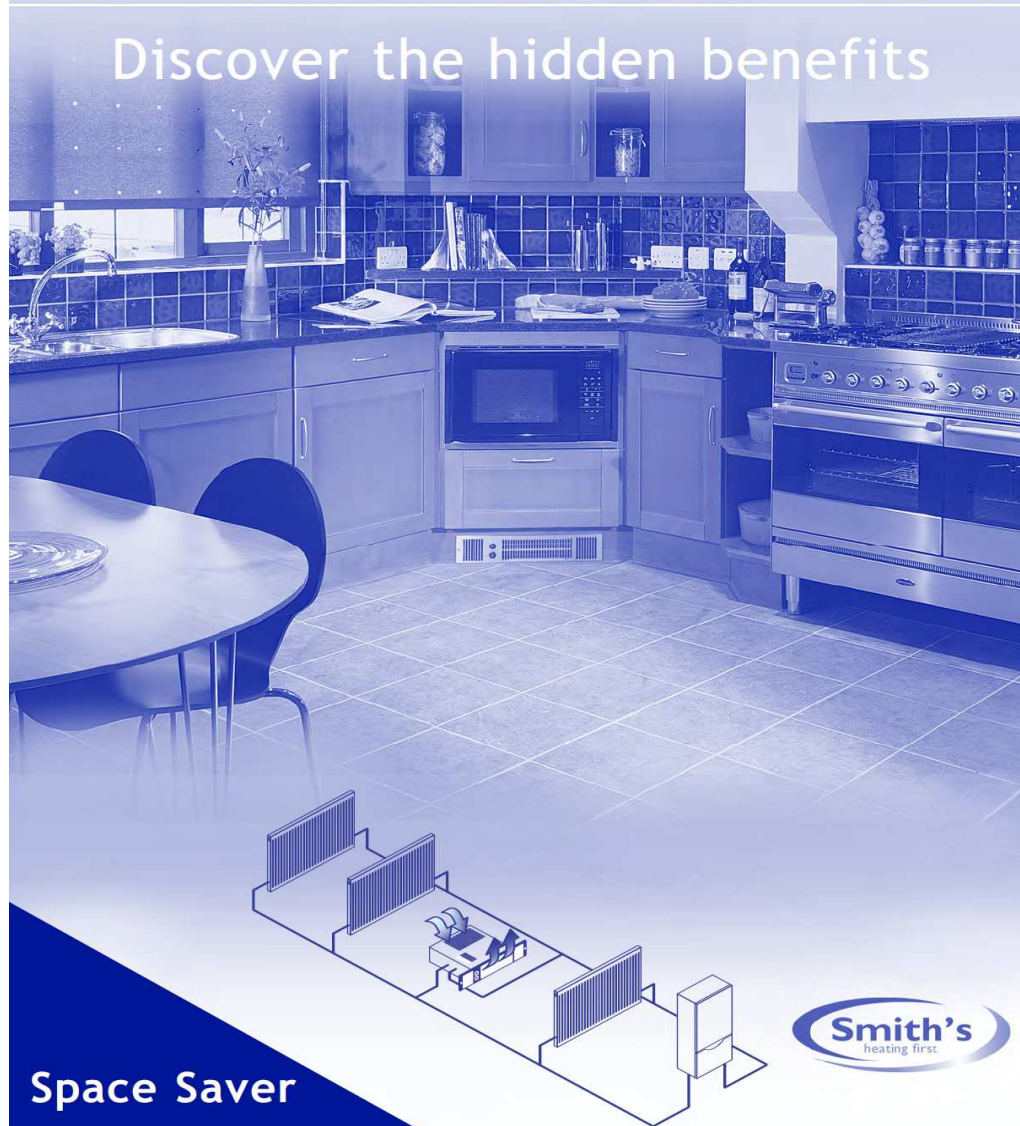

Space Saver

User Guide

SS5 /Dual

User Information

- ❖ Your product is covered by a **free 5-year and labour guarantee**; please complete and return the Guarantee Registration Card to us as soon as possible to ensure that should you require assistance, we can help you quickly and more efficiently.
- ❖ Your Space Saver fan convector is designed to operate as part of your central heating system in the same way as a panel radiator. Providing you leave Space Saver in hydronic heating mode, it will switch on and off automatically with your central heating system.

How your Space Saver fan convector work

Hot water from your central heating system passes through a heat exchanger transferring its heat to the aluminium fins. Cooler air is drawn in by the fan and heated as it passes through the heat exchanger before being discharged gently back into the room. This not only gives a more even temperature spread, but will heat up a room in less than half the time of a traditional panel radiator.

A supplementary electric heating element allows you heat when the central heating is switched off. Please note that if your central heating comes on while the Space Saver is switched to electric heating mode, the element will automatically switch off. Using Hydronic heating mode where possible will considerably reduce running costs.

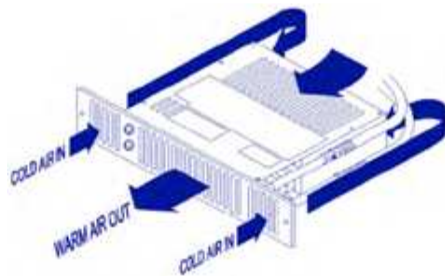

Space Saver includes an internal thermostat that prevents the fan from operating until the central heating system water passing through the heat exchanger reaches 38°C. This prevents Space Saver circulating cooler air at start up.

Hydronic Heating

Ensure your central heating system is on. Check the upper rocker switch is to the left (red), the middle rocker switch to the left (hydronic heating) and the lower rocker switch either to the left (normal) or right (boost). Providing the water temperature in the system is more than 38°C and the thermostat controlling your central heating system is calling for heat, your Space Saver will switch on. Moving the upper rocker switch to its Centre position will turn off the Space Saver

Air Circulation (summer use)

Ensure your central heating is off. Check the upper rocker switch is to the right (blue), the middle rocker switch to the left or right and the lower rocker switch either to the left (normal)

Fault Finding

This Space Saver is covered by a free 5-year parts and labour guarantee. Please refer to the Fault Finding section on page 15 for advice. In the event of difficulty, please contact us on 01245 324560. It will be helpful if you do not disconnect the Space Saver from the central heating system.

or right (boost). Space Saver will provide a cooling flow of air. If used in conjunction with a room thermostat, ensure the thermostat is set to maximum.

1. We recommend the use of a kneepad when installing this product. Cut the opening in the plinth to the size shown in the table. Use Method A or B.

Model	Width A	Height B*
SS5 /Dual	475mm	96mm

* The overall height of the grille is 100mm. Use care when cutting the opening.

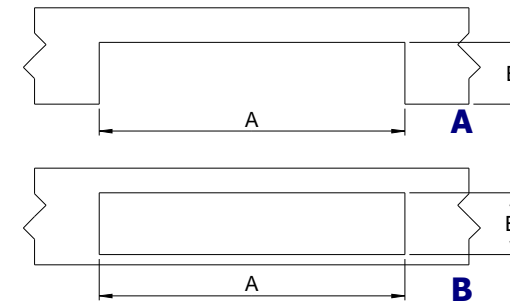

2. Fit isolating valves (not supplied) to the system flow and return pipes. Failure to fit isolating valves may mean that the product is not serviceable in the event of failure. Connect the flexible hoses between the system pipework and the heater. Open the isolating valves and check for leaks.

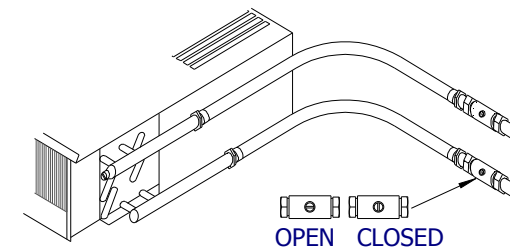

N.B. either pipe may be used for flow or return.

3. Vent air through the bleed screw.

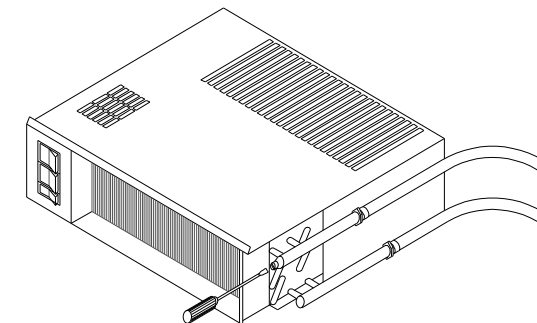

4. Isolate electrical supply and connect the heater electric cable to the fused spur (5A). Ensure the fused spur is not directly above the heater and is accessible after installation is complete.

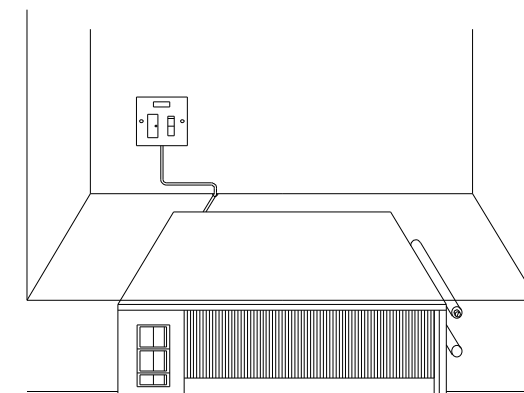

Commissioning

1. Turn on the electrical supply at the fused spur.
2. Set the upper rocker switch on the fascia grille to the right (blue) and the lower switch to the left or right - the fan should run.
3. Set the upper rocker switch to the left (red) and the middle rocker switch to the right (electric heating). Heat will start to flow immediately. Increasing the fan speed will not increase the heat output in the electric heating mode.
4. Turn on the central heating system.
5. Set any room thermostat/s to maximum.
6. Set the upper rocker switch to the left (red), the middle rocker switch to the left (hydronic heating) and the lower switch to the left (normal output). The fan should run and heat will flow within a few minutes.
7. Balance the central heating system if Space Saver is installed on the same circuit as panel radiators.
8. When the installation is working correctly, remember to reset any thermostat/s to there normal setting.

5. Position heater, making sure the flexible hoses are not kinked and the electrical cable is not snagged.

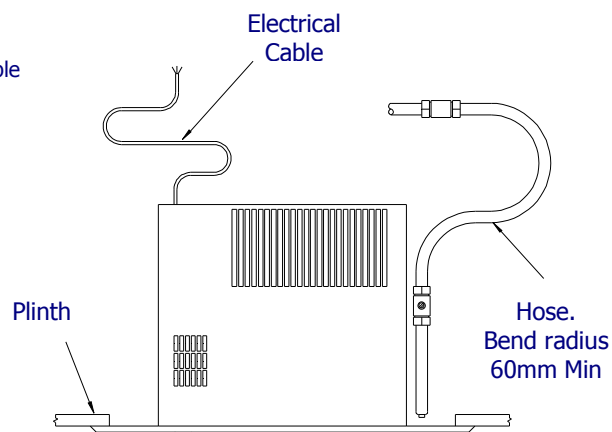

- 6a. Fit supplied grille over top flange, locate over switches then press lower backwards as shown in diagram to fix in place.

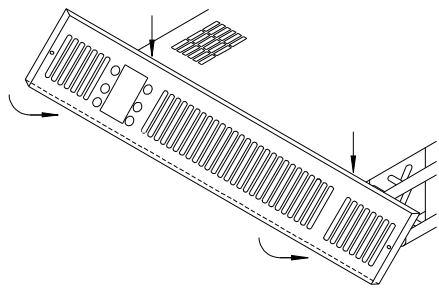

- 6b. Fix assembled heater to plinth using fixing screw holes located at either ends of grille.

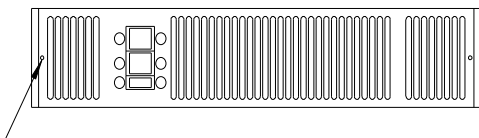

Grille to plinth securing screws

Heat Output Performance

It is recommended that the Space Saver model chosen is capable of maintaining the calculated heat loss at normal heat output (I) enabling the boost setting (II) to be used for faster heat up.

Model	Heat Output $\Delta 60^{\circ}\text{C}$		Heat Output $\Delta 50^{\circ}\text{C}$	
	Normal (kW)	Boost (kW)	Normal (kW)	Boost (kW)
SS5 /Dual	1.3	1.7	1.1	1.4

Notes:

Dual models include an electric element which in electric heating mode will emit 1kW of heat.

$\Delta T 60^{\circ}\text{C}$ assumes a mean water temperature of 80°C and a room temperature of 20°C .

$\Delta T 50^{\circ}\text{C}$ assumes a mean water temperature of 70°C and a room temperature of 20°C .

Fault Finding

1. Fan does not run on any switch setting or no heat output on electric heating mode.
 - a. Check the power supply is switched ON.
 - b. Check the fuse in the fused spur.
 - c. Check the wiring connections at the fused spur.
2. No heat output on hydronic heating mode.
 - a. Check the power supply is switched ON.
 - b. If fitted, ensure the room thermostat is calling for heat.
 - c. Balance the central heating system if installed on the same circuit as panel radiators and increase the circulating pump speed if required.
 - d. Increase the boiler water temperature.
3. If the overheat protection has activated on electric heating mode, manually reset as follows.
 - a. Switch the power supply OFF at the fused spur.
 - b. Wait five minutes for the overheat cut off switch to reset and then switch the power supply ON.

In the event of any difficulty, please contact us on 01245 324560.
It will be more helpful if you do remove the product from the central heating system.